

The logo for ERKADO, featuring three horizontal black bars to the left of the word "ERKADO" in a bold, red, sans-serif font.

doors are our world



INTERNAL DOORS  
CATALOGUE GUIDE  
2024

EN

Edition 1/2024/A



LUKRECJA 1, ST CPL OAK facing layer, handle: BELLA SLIM, satin brass

## ERKADO doors are our world

Every house is fitted with interior doors. This is why approaching doors only from the point of view of their functionality and practicality has long been insufficient. Underlining the best qualities in a perfectly furnished house, today they are an important component of interior design. For this reason, we create modern solutions, introduce attractive design and focus on the quality of workmanship to let you enjoy the choice of the Erkado doors.

We are committed to developing all business areas relevant for creating a product that meets your expectations. We achieve this goal by investing in technologically advanced production lines, staff training and systematic analysis of consumer needs. Our dynamic development would be impossible without the activity of the sales network participants. Thank you for your inspiring suggestions and friendly feedback.



<b>STILE PANELLED DOORS</b> .....	<b>6</b>
LAURENCJA .....	6
FREZJA <b>NEW</b> .....	8
NEMEZJA .....	10
PEONIA <b>NEW</b> .....	12
AMARYLIS <b>NEW</b> .....	14
MISKANT .....	16
BUDLEJA .....	18
LUKRECJA <b>NEW</b> .....	20
MAGNOLIA .....	22
EPIMEDIUM <b>NEW</b> .....	24
ARALIA, NOLINA, EWODIA .....	26
POWOJNIK .....	28
JUKA <b>BEST PRICE!</b> .....	30
FORSYCJA <b>BEST PRICE!</b> .....	32
LAWENDA <b>BEST PRICE!</b> .....	34
IRYS .....	36
DAGLEZJA .....	38
DEBECJA .....	40
SURMIA .....	42
BERBERYS .....	44
FLOKS .....	46
KROKUS .....	48
KAMELIA .....	50
PETUNIA .....	52
AZALIA .....	54
HIACYNT .....	56
FRAGI .....	58
<b>GRAF GLASS DOORS</b> <b>NEW</b> .....	<b>60</b>
<b>DECORATIVE LAMELLAS</b> .....	<b>62</b>
<b>LACQUERED DOORS</b> .....	<b>64</b>
AMARYLIS <b>NEW</b> .....	64
PEONIA <b>NEW</b> .....	66
MISKANT .....	68
NEMEZJA .....	70
LAURENCJA .....	72
BALDUR .....	74
ANUBIS .....	76
UNO PREMIUM .....	78
TURAN <b>NEW</b> .....	80
MILDA .....	82
SYLENA .....	84
<b>INLAYS</b> <b>NEW</b> .....	<b>86</b>
<b>FLUSH DOORS</b> .....	<b>92</b>
BALDUR .....	92
UNO PREMIUM .....	94
ALTAMURA .....	96
ANSEDONIA .....	98
LORIENT .....	100
MENTON .....	102
SORANO .....	104
<b>INTERIOR FRONT DOORS</b> .....	<b>106</b>
FORTECA RC2 .....	106
FORTECA RC3 .....	106
FIXED DOOR FRAME FOR FORTECA .....	110
STEEL DOOR FRAMES FOR FORTECA .....	111
HERSE SET i HERSE MAX SET .....	112
FIXED AND ADJUSTABLE DOOR FRAME FOR HERSE SET SERIES .....	114
STEEL DOOR FRAMES FOR FORTECA HERSE SET .....	116
UNITED STEEL DOOR FRAME FOR THE HERSE SET SERIES .....	117
<b>INTERIOR FIRE PROTECTION FRONT DOORS</b> .....	<b>118</b>
LEDA EI30 .....	118
LEDA EI60 .....	118
WOODEN DOOR FRAME FOR LEDA SERIES .....	120
STEEL DOOR FRAMES FOR LEDA SERIES .....	120
DOUBLE LEDA EI30 & EI60 .....	121
<b>HARDWARE – HANDLES</b> <b>NEW</b> .....	<b>122</b>
<b>TECHNICAL INFORMATION</b> .....	<b>133</b>
<b>CROSSHEADS AND PILASTERS</b> <b>NEW</b> .....	<b>139</b>
<b>DOOR FRAME EXTENSION PANELS</b> <b>NEW</b> .....	<b>140</b>
<b>WALL-MOUNTED SLIDING DOOR SYSTEMS</b> .....	<b>142</b>
<b>POCKET SLIDING DOOR SYSTEMS</b> .....	<b>148</b>
<b>DOUBLE DOORS</b> .....	<b>151</b>
<b>FOLDING DOORS</b> .....	<b>154</b>
<b>COVERT CONCEALED DOOR SYSTEM</b> .....	<b>155</b>
<b>SIDELIGHTS FOR DOORS</b> .....	<b>158</b>
<b>DOOR FRAMES</b> .....	<b>160</b>
TUNNEL TYPE ADJUSTABLE DOOR FRAME .....	163
STEEL DOOR FRAME .....	164
NON-REBATED STEEL DOOR FRAME <b>NEW</b> .....	165
ADJUSTABLE CASING FRAME FOR STEEL DOOR FRAMES .....	166
REVERSE DOOR FRAME .....	167
ADJUSTABLE DOOR FRAME FOR NON-REBATED DOORS .....	168
FIXED FRAME FOR REBATED DOORS .....	169
ADJUSTABLE DOOR FRAME FOR REBATED DOORS .....	170

# FACING LAYERS

COLOURS AVAILABLE FOR INTERIOR DOORS

## GREKO



## PREMIUM

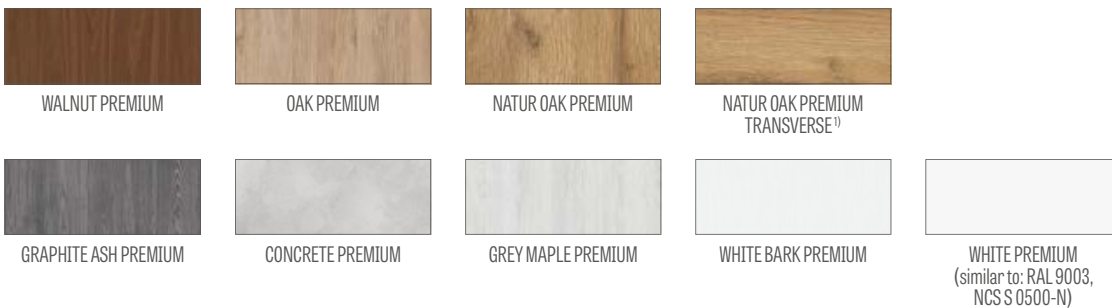

## CPL

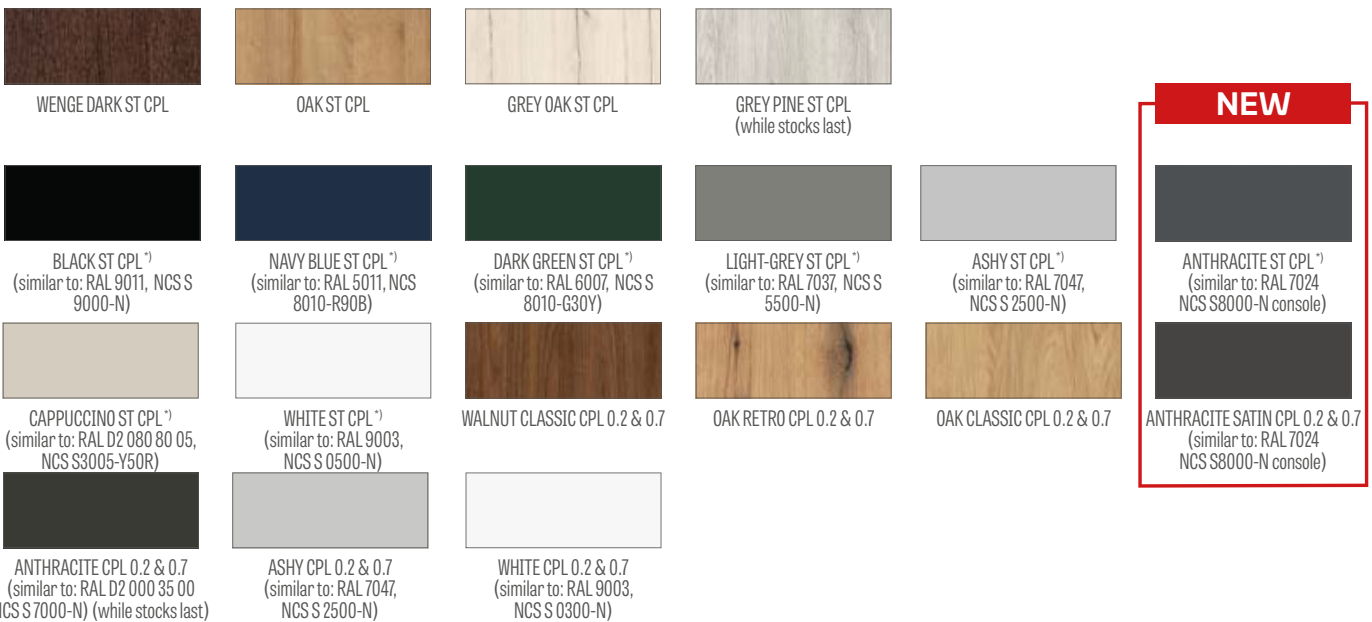

## UV-PAINTED

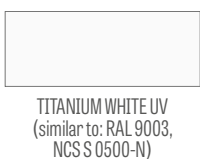

Read more on facings on p. 134

\* special AntiFinger coating to reduce dirt and fingerprints

<sup>1)</sup> Only used on selected flush doors.  
comes complete with the NATUR OAK PREMIUM door frame

# STILE PANELLED DOORS

REBATED AND NON-REBATED



<sup>1)</sup> Available at extra charge for rebated and non-rebated models, and the non-rebated models for sliding systems in PL and CZ standard for WHITE PREMIUM, NATUR OAK PREMIUM, GRAPHITE ASH PREMIUM, GREY MAPLE PREMIUM, OAK ST CPL

# LAURENCJA

REBATED AND NON-REBATED INTERIOR STILE PANELLED DOORS



LAURENCJA 1, WHITE ST CPL facing layer, VSG black glass, handle: QUANTA FIT, black matt



LAURENCJA 1



LAURENCJA 2



LAURENCJA 3



LAURENCJA 4



LAURENCJA 5



LAURENCJA 6

LAURENCJA 1 with PREMIUM WHITE facing layer, CUBE PREMIUM handle, black matt, and black VSG 221 laminated glass



## DESIGN

- rebated or non-rebated door leaf made in the STILE panelled technology
- MDF stiles and rails covered with the PREMIUM, ST CPL facings or ST CPL laminate with the AntiFinger coating
- glued laminated timber stiles covered with HDF and MDF boards<sup>4)</sup>
- 4 mm thick HDF panels with CPL or PREMIUM facing
- very wide crossbar - 35 mm
- optional door frame extension panels and a crossheads with pilasters are available for surcharge, pp. 139-141
- the door can be trimmed by a customer; go to p. 137 for details

## HARDWARE

- rebated door leaves: three silver 2-pin hinges adjusted horizontally
- three concealed hinges in a non-rebated leaf, silver (optionally black - subject to an additional charge); hinges supplied with and included in the price of the door frame
- lever tumbler lock in a rebated door leaf and a key-locked magnetic lock (lever tumbler lock as an option) in a non-rebated door leaf, thumb turn cylinder, economy, with a silver blockade; optionally, against an additional charge, a black or gold magnetic lock

## GLAZING

- tempered 4 mm glass, frosted or clear as a standard and, against an additional charge, laminated VSG 221 safety glass frosted or black plain on both sides
- possibility to change the glazing side to REVERSE (standard glazing for OBVERSE)

## AVAILABLE SOLUTIONS (pp. 142-153)

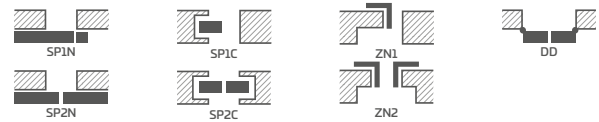

## AVAILABLE DOOR LEAF WIDTHS

60 70 80N<sup>5)</sup> 80 90 100

## PREMIUM



## CPL

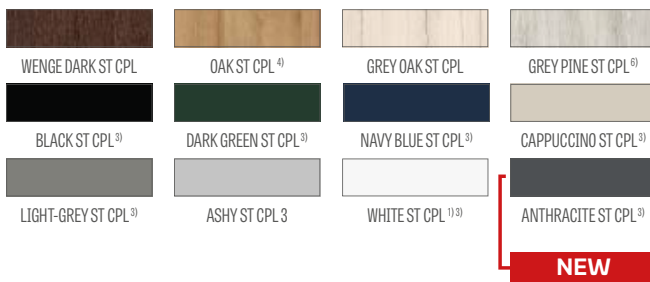

Glulam timber stiles<sup>4)</sup>

## EXTRA CHARGES

factory pre-drilled through holes for handles (split handles) ordered together with the door leaf

enhanced airflow trim, ventilation undercut standard or mini (p. 137)

plastic woodgrain sleeves (4 pcs)

round and square metal sleeves (4 pcs); brushed nickel or patina finish in white and black

ventilation grille (only for door leaf widths of 80, 90, 100)

"100" rebated and non-rebated door leaf

VSG 221 laminated safety glass, plain on both sides

metal hinge casings in rebated door leaf

(colour: brushed nickel, patina, glossy chrome, glossy brass, white and black)

drop down seal<sup>2)</sup>

can be replaced with a black or golden magnetic lock for non-rebated door leaves

can be changed to hinges and strike plate in black or gold for non-rebated door leaves

magnetic stop (buffer)<sup>2)</sup>  
(available in six colours p. 137)

glulam timber stiles<sup>4)</sup>

<sup>1)</sup> plain white facing imitating a painted surface

<sup>2)</sup> a stop will not allow a drop down seal and an enhanced airflow trim to be used, and vice versa

<sup>3)</sup> special **AntiFinger** coating to reduce dirt and fingerprints

<sup>4)</sup> glulam timber stiles covered with HDF and MDF boards available for WHITE PREMIUM, NATUR OAK PREMIUM, GRAPHITE ASH PREMIUM, GREY MAPLE PREMIUM, OAK ST CPL at extra charge

<sup>5)</sup> only for non-rebated door leaves

<sup>6)</sup> until stock lasts

# FREZJA

REBATED AND NON-REBATED INTERIOR STILE PANELLED DOORS



FREZJA 9, ASH ST CPL facing layer; handle: BELLA SLIM, glossy chrome



FREZJA 1



FREZJA 2



FREZJA 3



FREZJA 4

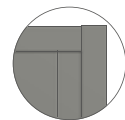

FREZJA 2

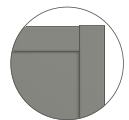

FREZJA 4

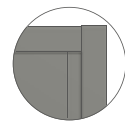

FREZJA 6



FREZJA 9  
panel edge 3 mm thick,  
always in black



FREZJA 5



FREZJA 6



FREZJA 7 <sup>3)</sup>



FREZJA 8 <sup>2)</sup>



FREZJA 8  
Ventilation undercut

<sup>2)</sup> FREZJA 8 – 8 mm thick glazing

<sup>3)</sup> FREZJA 7 - model only with a mirror; the other side - aboard covered in a given facing layer. Obverse - a mirror fitted on the hinge side (as shown in the photo)

FREZJA 9<sup>8)</sup> in LIGHT GREY ST CPL facing layer with QUANTA FIT handle, black matt



## DESIGN

- rebated or non-rebated door leaf made in the STILE panelled technology
- MDF stiles and rails covered with the GREKO, PREMIUM, ST CPL facings or ST CPL laminate with the AntiFinger coating
- glued laminated timber stiles covered with HDF and MDF boards<sup>6)</sup>
- 16 mm thick HDF panels (also a 4 mm panel for the FREZJA 2 & 6 models) covered with the GREKO, CPL or PREMIUM facing; FREZJA 7 is available with a mirror only
- in FREZJA 9 model, the panel is made of moisture-resistant HDF board 3 mm thick, applied to glass on both sides. **The edge of the panel is always made in black.**
- optional door frame extension panels and a crossheads with pilasters are available for surcharge, pp. 139-141
- the door can be trimmed by a customer, go to p. 137 for details
- **model FREZJA 9<sup>8)</sup> NEW**

## HARDWARE

- rebated door leaves: three silver 2-pin hinges adjusted horizontally
- three concealed hinges in a non-rebated leaf, silver (optionally black - subject to an additional charge); hinges supplied with and included in the price of the door frame
- lever tumbler lock in a rebated door leaf and a key-locked magnetic lock (lever tumbler lock as an option) in a non-rebated door leaf, thumb turn cylinder, economy, with a silver blockade; optionally, against an additional charge, a black or gold magnetic lock

## GLAZING

- frosted or clear tempered glass or a mirror fitted on one side (only Frezja 7) as standard, and custom-made frosted or black VSG 221 laminated safety glass, plain on both sides (not in FREZJA 7 & 8)
- possibility to change the glazing side to REVERSE (standard glazing for OBVERSE)
- fixed glazing width; FREZJA 1 - 140 mm, FREZJA 5 - 70 mm, FREZJA 9 - 50 mm

## GREKO



## PREMIUM

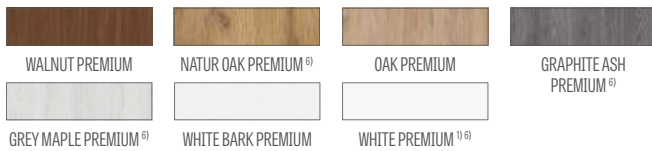

## CPL



**NEW**



Glulam timber stiles<sup>6)</sup>

<sup>1)</sup> plain white facing imitating a painted surface

<sup>2)</sup> not available in FREZJA 8

<sup>3)</sup> FREZJA 8 is not available for sliding systems

<sup>4)</sup> a stop will not allow a drop down seal and an enhanced airflow trim to be used, and vice versa

<sup>5)</sup> special **AntiFinger** coating to reduce dirt and fingerprints

<sup>6)</sup> glulam timber stiles covered with HDF and MDF boards available for WHITE PREMIUM, NATUR OAK PREMIUM, GRAPHITE ASH PREMIUM, GREY MAPLE PREMIUM, OAK ST CPL at extra charge

<sup>7)</sup> only for non-rebated door leaves

<sup>8)</sup> **model FREZJA 9 only available in facing layers OAK NATUR PREMIUM, WHITE ST CPL, CAPPUCCINO ST CPL, LIGHT GREY ST CPL, BLACK ST CPL, DARK GREY ST CPL, NAVY BLUE ST CPL, ASH ST CPL, ANTHRACITE ST CPL**

<sup>9)</sup> until stock lasts

<sup>10)</sup> not available in GREKO decors

## AVAILABLE SOLUTIONS (pp. 142-153)

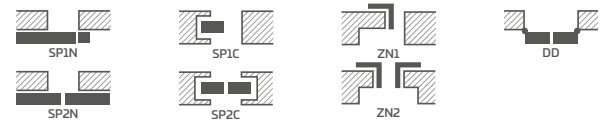

## AVAILABLE DOOR LEAF WIDTHS

60 70 80N<sup>7)</sup> 80 90 100

## EXTRA CHARGES

factory pre-drilled through holes for handles (split handles) ordered together with the door leaf

enhanced airflow trim, ventilation undercut standard or mini (p. 137)

plastic woodgrain sleeves (4 pcs)<sup>2)</sup>

round and square metal sleeves<sup>2)</sup>: (4 pcs.); brushed nickel or patina finish white and black

ventilation grille<sup>2)</sup> (only for door leaf widths of: 80, 90, 100)

"100" rebated and non-rebated door leaf

VSG 221 laminated safety glass, plain on both sides

metal hinge casings in the rebated door leaf (brushed nickel, patina, polished chrome, polished brass, white and black)

drop down seal<sup>4)</sup> (not for FREZJA 8)

can be replaced with a black or golden magnetic lock for non-rebated door leaves

can be changed to hinges and strike plate in black or gold for non-rebated door leaves

magnetic stop (buffer)<sup>4)</sup>

(available in six colours p. 137)

glulam timber stiles<sup>6)</sup>

PL2112 standard<sup>10)</sup>

+15% on the door price before surcharges

# NEMEZJA

REBATED AND NON-REBATED INTERIOR STILE PANELLED DOORS



NEMEZJA 14, ANTHRACITE ST CPL facing layer; handle: QUANTA FIT, black matt



NEMEZJA 1



NEMEZJA 4



NEMEZJA 6



NEMEZJA 7



NEMEZJA 8



NEMEZJA 9



NEMEZJA 10



NEMEZJA 11



NEMEZJA 12



NEMEZJA 13

NEMEZJA 14 in CAPPUCCINO ST CPL facing layer with BELLA SLIM handle glossy brass, pilasters and decorative crossheads<sup>7)</sup>



## DESIGN

- rebated or non-rebated door leaf made in the STILE panelled technology
- MDF stiles and rails covered with the GREKO, PREMIUM, ST CPL facings or ST CPL laminate with the AntiFinger coating
- glued laminated timber stiles covered with HDF and MDF boards<sup>4)</sup>
- bevelled 16 mm thick HDF panels with a selection of GREKO, CPL or PREMIUM facing
- optional door frame extension panels and a crossheads with pilasters are available for surcharge, pp. 139-141
- the door can be trimmed by a customer, go to p. 137 for details

## HARDWARE

- rebated door leaves: three silver 2-pin hinges adjusted horizontally
- three concealed hinges in a non-rebated leaf, silver (optionally black - subject to an additional charge); hinges supplied with and included in the price of the door frame
- lever tumbler lock in a rebated door leaf and a key-locked magnetic lock (lever tumbler lock as an option) in a non-rebated door leaf, thumb turn cylinder, economy, with a silver blockade; optionally, against an additional charge, a black or gold magnetic lock

## GLAZING

- tempered 4 mm glass, frosted or clear as a standard and, against an additional charge, laminated VSG 221 safety glass frosted or black plain on both sides
- possibility to change the glazing side to REVERSE (OBSERVE - standard glazing)

## AVAILABLE SOLUTIONS (pp. 142-153)

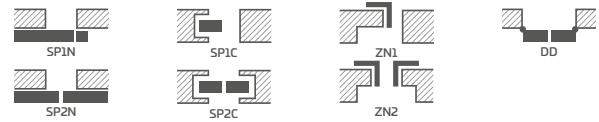

## AVAILABLE DOOR LEAF WIDTHS

60 70 80N<sup>5)</sup> 80 90 100

### GREKO

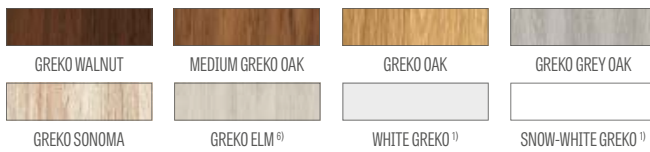

### PREMIUM

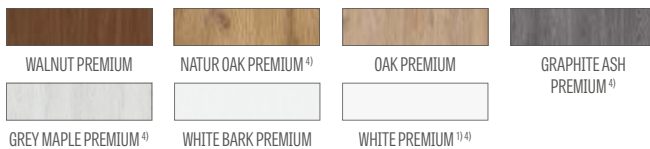

### CPL

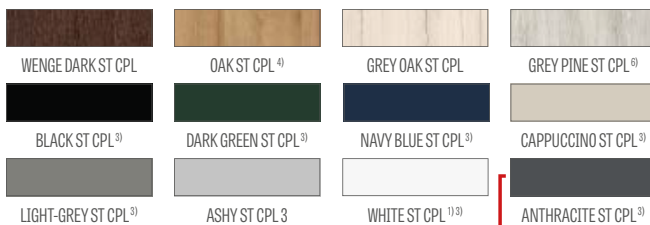

**NEW**



Glulam timber stiles<sup>4)</sup>

## EXTRA CHARGES

factory pre-drilled through holes for handles (split handles) ordered together with the door leaf

enhanced airflow trim, ventilation undercut standard or mini (p. 137)

plastic woodgrain sleeves (4 pcs)

round and square metal sleeves (4 pcs); brushed nickel or patina finish in white and black

ventilation grille (only for door leaf widths of 80, 90, 100)

"100" rebated and non-rebated door leaf

VSG 221 laminated safety glass, plain on both sides

metal hinge casings in the rebated door leaf (brushed nickel, patina, polished chrome, polished brass, white and black)

drop down seal<sup>2)</sup>

can be replaced with a black or golden magnetic lock for non-rebated door leaves

can be changed to hinges and strike plate in black or gold for non-rebated door leaves

magnetic stop (buffer)<sup>2)</sup>  
(available in six colours p. 137)

glulam timber stiles<sup>4)</sup>

PL2112 standard<sup>8)</sup>

+15% on the door price before surcharges

<sup>1)</sup> plain white facing imitating a painted surface

<sup>2)</sup> a stop will not allow a drop down seal and an enhanced airflow trim to be used, and vice versa

<sup>3)</sup> special **AntiFinger** coating to reduce dirt and fingerprints

<sup>4)</sup> glulam timber stiles covered with HDF and MDF boards available for WHITE PREMIUM, NATUR OAK PREMIUM, GRAPHITE ASH PREMIUM, GREY MAPLE PREMIUM, OAK ST CPL at extra charge

<sup>5)</sup> only for non-rebated door leaves

<sup>6)</sup> until stock lasts

<sup>7)</sup> decorative crossheads with pilasters for surcharge, p. 139

<sup>8)</sup> not available in GREKO decors

# PEONIA

REBATED AND NON-REBATED INTERIOR STILE PANELLED DOORS



PEONIA 2, frosted glass, DARK NAVY ST CPL facing layer, BELLA SLIM handle, glossy brass, pilasters and decorative crossheads<sup>6)</sup>



PEONIA 1



PEONIA 2



PEONIA 3



PEONIA 4



PEONIA 5



PEONIA 6



**NEW**

Double-sided stick-on muntin 25 mm wide  
in leaf colour or black

PEONIA 3, ASHY ST CPL facing layer with CUBE PREMIUM handle in black matt, pilasters and decorative crossheads<sup>6)</sup>



## DESIGN

- rebated or non-rebated door leaf made in the STILE panelled technology
- MDF stiles and rails covered with the GREKO, PREMIUM, ST CPL facings or ST CPL laminate with the AntiFinger coating
- glued laminated timber stiles covered with HDF and MDF boards<sup>4)</sup>
- Bevelled 16 mm thick HDF panels with a selection of GREKO, CPL or PREMIUM facing
- double-sided muntin applied to glass, 25 mm wide and of respective heights: vertical 12 mm and horizontal 8 mm
- optional change of muntin facing layer to the BLACK ST CPL colour regardless of the leaf facing layer **NEW**
- optional door frame extension panels and a crossheads with pilasters are available for surcharge, pp. 139-141
- the door can be trimmed by a customer, go to p. 137 for details

## HARDWARE

- rebated door leaves: three silver 2-pin hinges adjusted horizontally
- three concealed hinges in a non-rebated leaf, silver (optionally black - subject to an additional charge); hinges supplied with and included in the price of the door frame
- lever tumbler lock in a rebated door leaf and a key-locked magnetic lock (lever tumbler lock as an option) in a non-rebated door leaf, thumb turn cylinder, economy, with a silver blockade; optionally, against an additional charge, a black or gold magnetic lock

## GLAZING

- tempered 4 mm glass, frosted or clear as a standard and, against an additional charge, laminated VSG 221 safety glass frosted or black plain on both sides
- possibility to change the glazing side to REVERSE (OBERSE - standard glazing)

## GREKO

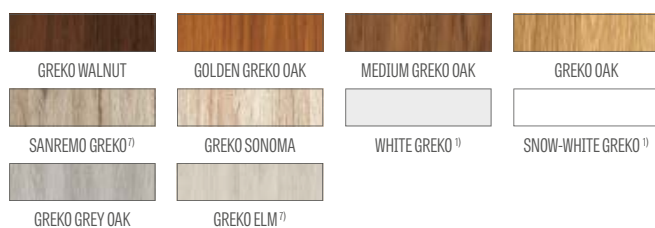

## PREMIUM



## CPL

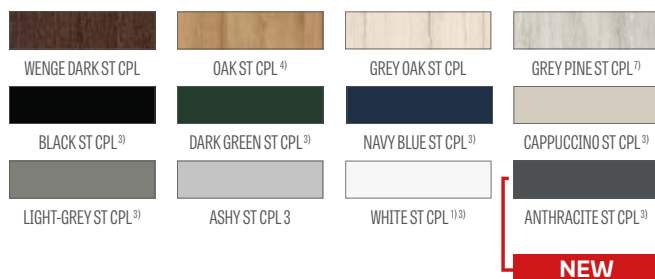

Glulam timber stiles<sup>4)</sup>

## AVAILABLE SOLUTIONS (pp. 142-153)

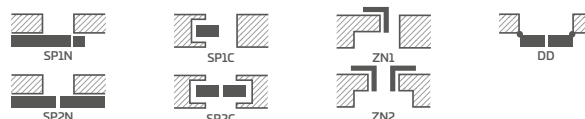

## AVAILABLE DOOR LEAF WIDTHS



## EXTRA CHARGES

factory pre-drilled through holes for handles (split handles) ordered together with the door leaf

enhanced airflow trim, ventilation undercut standard or mini (p. 137)

plastic woodgrain sleeves (4 pcs)

round and square metal sleeves (4 pcs); brushed nickel or patina finish in white and black

ventilation grille (only for door leaf widths of 80, 90, 100)

"100" rebated and non-rebated door leaf

VSG 221 laminated safety glass, plain on both sides

metal hinge casings in the rebated door leaf (brushed nickel, patina, polished chrome, polished brass, white and black)

drop down seal<sup>2)</sup>

can be replaced with a black or golden magnetic lock for non-rebated door leaves

can be changed to hinges and strike plate in black or gold for non-rebated door leaves

magnetic stop (buffer)<sup>2)</sup>  
(available in six colours p. 137)

glulam timber stiles<sup>4)</sup>

PL2112 standard<sup>6)</sup>

+15% on the door price before surcharges

<sup>1)</sup> plain white facing imitating a painted surface

<sup>2)</sup> a stop will not allow a drop down seal and an enhanced airflow trim to be used, and vice versa

<sup>3)</sup> special **AntiFinger** coating to reduce dirt and fingerprints

<sup>4)</sup> glulam timber stiles covered with HDF and MDF boards available for WHITE PREMIUM, NATUR OAK PREMIUM, GRAPHITE ASH PREMIUM, GREY MAPLE PREMIUM, OAK ST CPL at extra charge

<sup>5)</sup> only for non-rebated door leaves

<sup>6)</sup> decorative crossheads with pilasters for surcharge, p. 139

<sup>7)</sup> until stock lasts

<sup>8)</sup> not available in GREKO decors

# AMARYLIS

REBATED AND NON-REBATED INTERIOR STILE PANELLED DOORS



AMARYLIS 2 clear glass, CAPPUCINO ST CPL facing layer, BELLA SLIM handle, glossy brass, pilasters and decorative crossheads<sup>7)</sup>

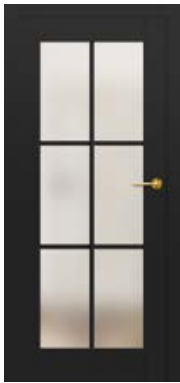

AMARYLIS 1

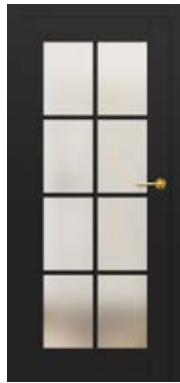

AMARYLIS 2



AMARYLIS 3



AMARYLIS 4



AMARYLIS 5



AMARYLIS 6



AMARYLIS 7



AMARYLIS 8



AMARYLIS 9



NEW

Double-sided stick-on muntin 25 mm wide  
in leaf colour or black

AMARYLLIS 3, NATUR OAK PREMIUM facing layer, handle: BELLA SLIM, round, black matt



**DESIGN**

- rebated or non-rebated door leaf made in the STILE panelled technology
- MDF stiles and rails covered with the GREKO, PREMIUM, ST CPL facings or ST CPL laminate with the AntiFinger coating
- glued laminated timber stiles covered with HDF and MDF boards<sup>4)</sup>
- double-sided muntin applied to glass, 25 mm wide and of respective heights: vertical 12 mm and horizontal 8 mm
- optional change of muntin facing layer to the BLACK ST CPL colour regardless of the leaf facing layer **NEW**
- optional door frame extension panels and a crossheads with pilasters are available for surcharge, pp. 139-141
- the door can be trimmed by a customer, go to p. 137 for details

**HARDWARE**

- rebated door leaves: three silver 2-pin hinges adjusted horizontally
- three concealed hinges in a non-rebated leaf, silver (optionally black - subject to an additional charge); hinges supplied with and included in the price of the door frame
- lever tumbler lock in a rebated door leaf and a key-locked magnetic lock (lever tumbler lock as an option) in a non-rebated door leaf, thumb turn cylinder, economy, with a silver blockade; optionally, against an additional charge, a black or gold magnetic lock

**GLAZING**

- tempered 4 mm glass, frosted or clear as a standard and, against an additional charge, laminated VSG 221 safety glass frosted or black plain on both sides
- possibility to change the glazing side to REVERSE (standard glazing for OBERSE)

**AVAILABLE SOLUTIONS** (pp. 142-153)

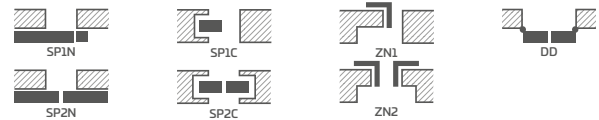

**GREKO**

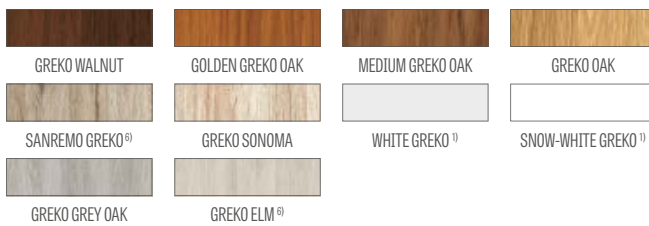

**PREMIUM**

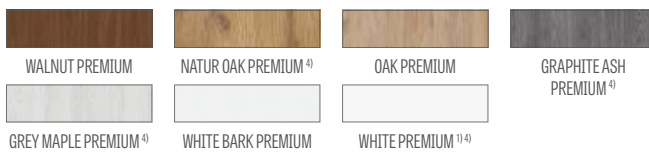

**CPL**

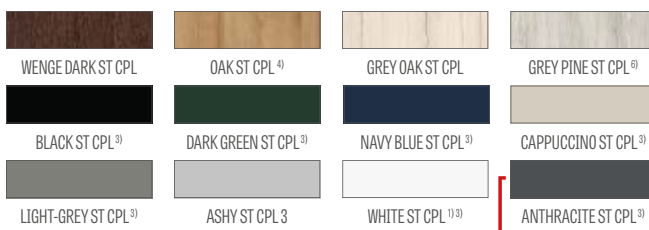

**AVAILABLE DOOR LEAF WIDTHS**



**EXTRA CHARGES**

factory pre-drilled through holes for handles (split handles) ordered together with the door leaf

VSG 221 laminated safety glass, plain on both sides

enhanced airflow trim, ventilation undercut standard or mini (p. 137)

plastic woodgrain sleeves (4 pcs)

round and square metal sleeves (4 pcs); brushed nickel or patina finish in white and black

ventilation grille (only for door leaf widths of 80, 90, 100)

"100" rebated and non-rebated door leaf

metal hinge casings in the rebated door leaf (brushed nickel, patina, polished chrome, polished brass, white and black)

drop down seal<sup>2)</sup>

can be replaced with a black or golden magnetic lock for non-rebated door leaves

can be changed to hinges and strike plate in black or gold for non-rebated door leaves

magnetic stop (buffer)<sup>2)</sup>  
(available in six colours p. 137)

glulam timber stiles<sup>4)</sup>

PL2112 standard<sup>6)</sup>

+15% on the door price before surcharges

<sup>1)</sup> plain white facing imitating a painted surface

<sup>2)</sup> a stop will not allow a drop down seal and an enhanced airflow trim to be used, and vice versa

<sup>3)</sup> special **AntiFinger** coating to reduce dirt and fingerprints

<sup>4)</sup> glulam timber stiles covered with HDF and MDF boards available for WHITE PREMIUM, NATUR OAK PREMIUM, GRAPHITE ASH PREMIUM, GREY MAPLE PREMIUM, OAK ST CPL at extra charge

<sup>5)</sup> only for non-rebated door leaves

<sup>6)</sup> until stock lasts

<sup>7)</sup> decorative crossheads with pilasters for surcharge, p. 139

<sup>8)</sup> not available in GREKO decors

# MISKANT

REBATED AND NON-REBATED INTERIOR STILE PANELLED DOORS



MISKANT 2, NATUR OAK PREMIUM facing layer, frame in BLACK ST CPL facing layer, BELLA SLIM handle, black matt



MISKANT 1



MISKANT 2

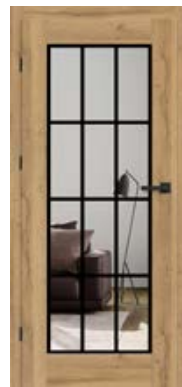

MISKANT 3



Black lines 18 mm wide  
silk-screen painted



MISKANT 4



MISKANT 5



MISKANT 6

MISKANT 3, NATUR OAK PREMIUM facing layer; Frame in BLACK ST CPL, handle: CUBE, black matt

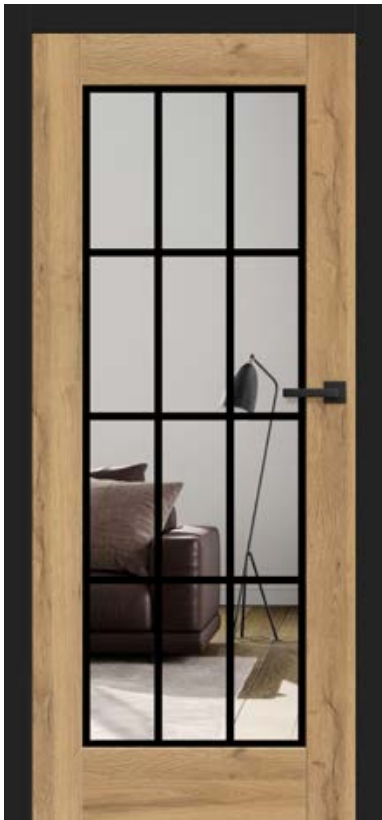

## DESIGN

- rebated or non-rebated door leaf made in the STILE panelled technology
- MDF stiles and rails covered with the GREKO, PREMIUM, ST CPL facings or ST CPL laminate with the AntiFinger coating
- glued laminated timber stiles covered with HDF and MDF boards<sup>4)</sup>
- optional door frame extension panels and a crossheads with pilasters are available for surcharge, pp. 139-141
- the door can be trimmed by a customer, go to p. 137 for details

## HARDWARE

- rebated door leaves: three silver 2-pin hinges adjusted horizontally
- three concealed hinges in a non-rebated leaf, silver (optionally black - subject to an additional charge); hinges supplied with and included in the price of the door frame
- lever tumbler lock in a rebated door leaf and a key-locked magnetic lock (lever tumbler lock as an option) in a non-rebated door leaf, thumb turn cylinder, economy, with a silver blockade; optionally, against an additional charge, a black or gold magnetic lock

## GLAZING

- tempered frosted glass (MISKANT 2, 4, 6) or clear glass (MISKANT 1, 3, 5), 4 mm thick or, for surcharge, VSG laminated glass with internal decorative pattern
- possibility to change the glazing side to REVERSE (standard glazing for OBERSE)
- black lines, 18 mm wide (thickness), screen printed on one side of the glazing

## AVAILABLE SOLUTIONS (pp. 142-153)

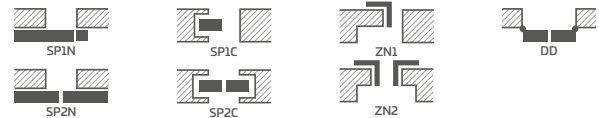

## AVAILABLE DOOR LEAF WIDTHS

60 70 80N<sup>5)</sup> 80 90 100

## EXTRA CHARGES

factory pre-drilled through holes for handles (split handles) ordered together with the door leaf

VSG laminated glass with internal decorative pattern in black or white

enhanced airflow trim, ventilation undercut standard or mini (p. 137)

plastic woodgrain sleeves (4 pcs)

round and square metal sleeves (4 pcs); brushed nickel or patina finish in white and black

ventilation grille (only for door leaf widths of 80, 90, 100)

"100" rebated and non-rebated door leaf

metal hinge casings in the rebated door leaf (brushed nickel, patina, polished chrome, polished brass, white and black)

drop down seal<sup>2)</sup>

can be replaced with a black or golden magnetic lock for non-rebated door leaves

can be changed to hinges and strike plate in black or gold for non-rebated door leaves

magnetic stop (buffer)<sup>2)</sup>  
(available in six colours p. 137)

glulam timber stiles<sup>4)</sup>

## GREKO



## PREMIUM



## CPL

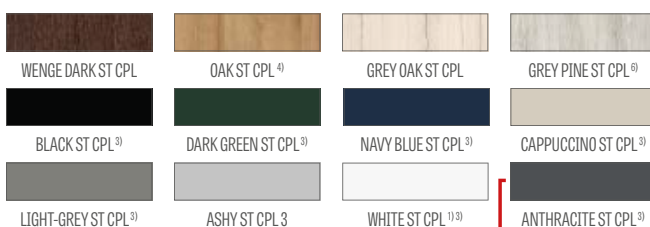

NEW



## STANDARD "OBERSE" GLAZING

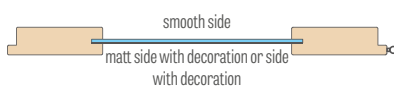

## "REVERSE" GLAZING MADE TO ORDER



<sup>1)</sup> plain white facing imitating a painted surface

<sup>2)</sup> a stop will not allow a drop down seal and an enhanced airflow trim to be used, and vice versa

<sup>3)</sup> special AntiFinger coating to reduce dirt and fingerprints

<sup>4)</sup> glulam timber stiles covered with HDF and MDF boards available for WHITE PREMIUM, NATUR OAK PREMIUM, GRAPHITE ASH PREMIUM, GREY MAPLE PREMIUM, OAK ST CPL at extra charge

<sup>5)</sup> only for non-rebated door leaves

<sup>6)</sup> until stock lasts

# BUDLEJA

REBATED AND NON-REBATED INTERIOR STILE PANELLED DOORS



BUDLEJA 6, OAK ST CPL facing layer; handle: CUBE PREMIUM, black matt



BUDLEJA 1



BUDLEJA 2



BUDLEJA 3



BUDLEJA 4



BUDLEJA 5



BUDLEJA 6



BUDLEJA 7



BUDLEJA 8

BUDLE.JA 1 in OAK ST CPL facing with TOPAZ Stainless steel handle



## DESIGN

- rebated or non-rebated door leaf made in the STILE panelled technology
- MDF stiles and rails covered with the PREMIUM, ST CPL facings or ST CPL laminate with the AntiFinger coating
- glued laminated timber stiles covered with HDF and MDF boards<sup>4)</sup>
- very wide crossbar - 35 mm
- optional door frame extension panels and a crossheads with pilasters are available for surcharge, pp. 139-141
- the door can be trimmed by a customer, go to p. 137 for details

## HARDWARE

- rebated door leaves: three silver 2-pin hinges adjusted horizontally
- three concealed hinges in a non-rebated leaf, silver (optionally black - subject to an additional charge); hinges supplied with and included in the price of the door frame
- lever tumbler lock in a rebated door leaf and a key-locked magnetic lock (lever tumbler lock as an option) in a non-rebated door leaf, thumb turn cylinder, economy, with a silver blockade; optionally, against an additional charge, a black or gold magnetic lock

## GLAZING

- tempered 4 mm glass, frosted or clear as a standard and, against an additional charge, laminated VSG 221 safety glass frosted or black plain on both sides
- possibility to change the glazing side to REVERSE (standard glazing for OBERVERSE)

## AVAILABLE SOLUTIONS (pp. 142-153)

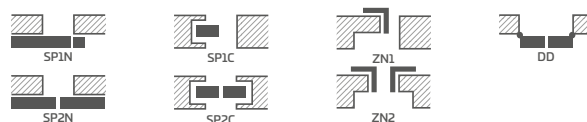

## AVAILABLE DOOR LEAF WIDTHS

60 70 80N<sup>5)</sup> 80 90 100

## EXTRA CHARGES

factory pre-drilled through holes for handles (split handles) ordered together with the door leaf

enhanced airflow trim, ventilation undercut standard or mini (p. 137)

plastic woodgrain sleeves (4 pcs)

round and square metal sleeves (4 pcs); brushed nickel or patina finish in white and black

ventilation grille (only for door leaf widths of 80, 90, 100)

"100" rebated and non-rebated door leaf

VSG 221 laminated safety glass, plain on both sides

metal hinge casings in rebated door leaf  
(colour: brushed nickel, patina, glossy chrome, glossy brass, white and black)

drop down seal<sup>2)</sup>

can be replaced with a black or golden magnetic lock for non-rebated door leaves

can be changed to hinges and strike plate in black or gold for non-rebated door leaves

magnetic stop (buffer)<sup>2)</sup>  
(available in six colours p. 137)

glulam timber stiles<sup>4)</sup>

## PREMIUM



## CPL

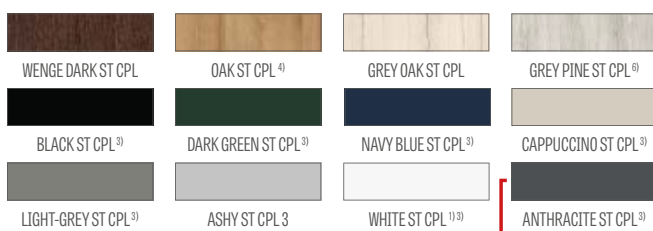

Glulam timber stiles<sup>4)</sup>

<sup>1)</sup> plain white facing imitating a painted surface

<sup>2)</sup> a stop will not allow a drop down seal and an enhanced airflow trim to be used, and vice versa

<sup>3)</sup> special AntiFinger coating to reduce dirt and fingerprints

<sup>4)</sup> glulam timber stiles covered with HDF and MDF boards available for WHITE PREMIUM, NATUR OAK PREMIUM, GRAPHITE ASH PREMIUM, GREY MAPLE PREMIUM, OAK ST CPL at extra charge

<sup>5)</sup> only for non-rebated door leaves

<sup>6)</sup> until stock lasts

# LUKRECJA

REBATED AND NON-REBATED INTERIOR STILE PANELLED DOORS



LUKRECJA 1, clear glass, OAK NATUR PREMIUM facing layer, BELLA SLIM handle, glossy brass



LUKRECJA 1



LUKRECJA 2



LUKRECJA 3



LUKRECJA 4



LUKRECJA 5



LUKRECJA 6



LUKRECJA 7



LUKRECJA 8



LUKRECJA 9



**NEW**

Double-sided stick-on muntin 25 mm wide  
in leaf colour or black

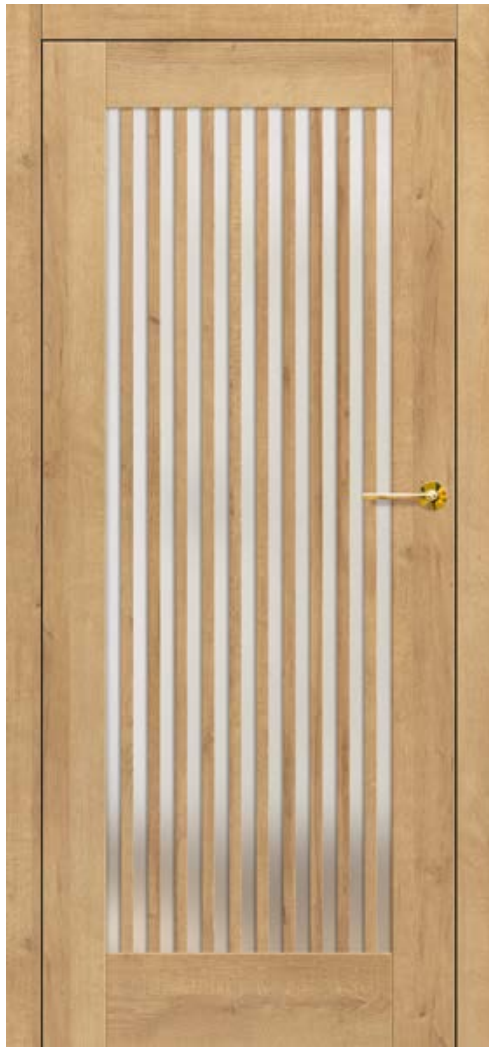

LUKRECJA 1, OAK ST CPL facing layer, BELLA SLIM handle, round, glossy brass

**DESIGN**

- rebated or non-rebated door leaf made in the STILE panelled technology
- MDF stiles and rails covered with the PREMIUM, ST CPL facings or ST CPL laminate with the AntiFinger coating
- glued laminated timber stiles covered with HDF and MDF boards<sup>4)</sup>
- double-sided muntin applied to glass, 25mm wide and 12mm high
- optional change of muntin facing layer to the BLACK ST CPL colour regardless of the leaf facing layer **NEW**
- optional door frame extension panels and a crossheads with pilasters are available for surcharge, pp. 139-141
- the door can be trimmed by a customer; go to p. 137 for details

**HARDWARE**

- rebated door leaves: three silver 2-pin hinges adjusted horizontally
- three concealed hinges in a non-rebated leaf, silver (optionally black - subject to an additional charge); hinges supplied with and included in the price of the door frame
- lever tumbler lock in a rebated door leaf and a key-locked magnetic lock (lever tumbler lock as an option) in a non-rebated door leaf, thumb turn cylinder, economy, with a silver blockade; optionally, against an additional charge, a black or gold magnetic lock

**GLAZING**

- tempered 4 mm glass, frosted or clear as a standard and, against an additional charge, laminated VSG 221 safety glass frosted or black plain on both sides
- possibility to change the glazing side to REVERSE (standard glazing for OBVERSE)

**AVAILABLE SOLUTIONS** (pp. 142-153)

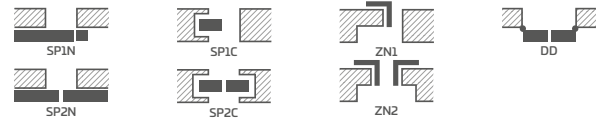

**AVAILABLE DOOR LEAF WIDTHS**

- 60 70 80N<sup>5)</sup> 80 90 100

**PREMIUM**

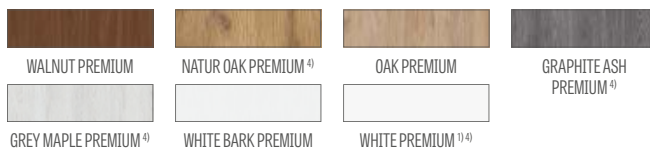

**CPL**

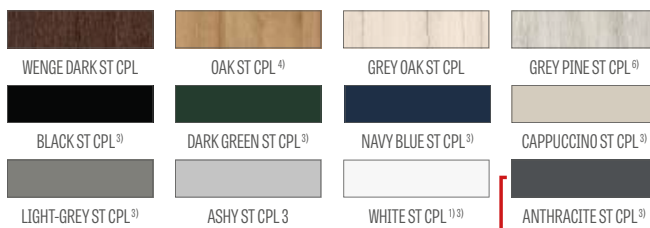

**NEW**



Glulam timber stiles<sup>4)</sup>

**EXTRA CHARGES**

- factory pre-drilled through holes for handles (split handles) ordered together with the door leaf
- VSG 221 laminated safety glass, plain on both sides
- enhanced airflow trim, ventilation undercut standard or mini (p. 137)
- plastic woodgrain sleeves (4 pcs)
- round and square metal sleeves (4 pcs); brushed nickel or patina finish in white and black
- ventilation grille (only for door leaf widths of 80, 90, 100)
- "100" rebated and non-rebated door leaf
- metal hinge casings in the rebated door leaf (brushed nickel, patina, polished chrome, polished brass, white and black)
- drop down seal<sup>2)</sup>
- can be replaced with a black or golden magnetic lock for non-rebated door leaves
- can be changed to hinges and strike plate in black or gold for non-rebated door leaves
- magnetic stop (buffer)<sup>2)</sup> (available in six colours p. 137)
- glulam timber stiles<sup>4)</sup>
- PL2112 standard +15% on the door price before surcharges

<sup>1)</sup> plain white facing imitating a painted surface  
<sup>2)</sup> a stop will not allow a drop down seal and an enhanced airflow trim to be used, and vice versa  
<sup>3)</sup> special AntiFinger coating to reduce dirt and fingerprints  
<sup>4)</sup> glulam timber stiles covered with HDF and MDF boards available for WHITE PREMIUM, NATUR OAK PREMIUM, GRAPHITE ASH PREMIUM, GREY MAPLE PREMIUM, OAK ST CPL at extra charge  
<sup>5)</sup> only for non-rebated door leaves  
<sup>6)</sup> until stock lasts



# MAGNOLIA

REBATED AND NON-REBATED INTERIOR STILE PANELLED DOORS



MAGNOLIA 1, OAK PREMIUM facing layer; TOPAZ Stainless steel handle



MAGNOLIA 1



MAGNOLIA 2



MAGNOLIA 3



MAGNOLIA 4



MAGNOLIA 5



MAGNOLIA 6



MAGNOLIA 7



MAGNOLIA 8

MAGNOLIA 1 with OAK PREMIUM facing layer and TOPAZ Stainless steel handle



## DESIGN

- rebated or non-rebated door leaf made in the STILE panelled technology
- MDF stiles and rails covered with the GREKO, PREMIUM, ST CPL facings or ST CPL laminate with the AntiFinger coating
- glued laminated timber stiles covered with HDF and MDF boards<sup>4)</sup>
- 4 mm thick HDF panels with GREKO, CPL or PREMIUM finish
- optional door frame extension panels and a crossheads with pilasters are available for surcharge, pp. 139-141
- the door can be trimmed by a customer, go to p. 137 for details

## HARDWARE

- rebated door leaves: three silver 2-pin hinges adjusted horizontally
- three concealed hinges in a non-rebated leaf, silver (optionally black - subject to an additional charge); hinges supplied with and included in the price of the door frame
- lever tumbler lock in a rebated door leaf and a key-locked magnetic lock (lever tumbler lock as an option) in a non-rebated door leaf, thumb turn cylinder, economy, with a silver blockade; optionally, against an additional charge, a black or gold magnetic lock

## GLAZING

- tempered 4 mm glass, frosted or clear as a standard and, against an additional charge, laminated VSG 221 safety glass frosted or black plain on both sides
- possibility to change the glazing side to REVERSE (standard glazing for OBERSE)

## AVAILABLE SOLUTIONS (pp. 142-153)

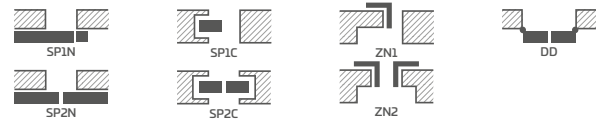

## GREKO

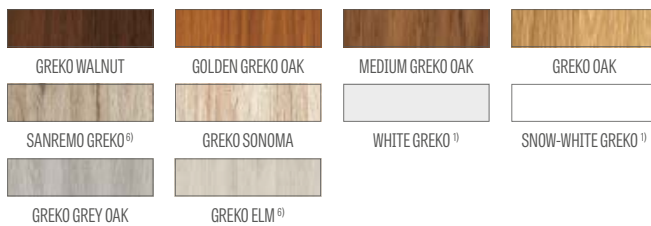

## PREMIUM

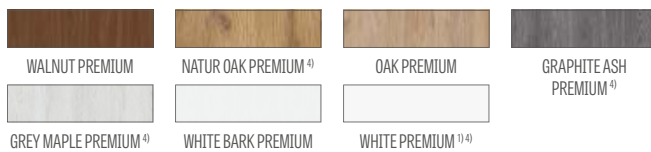

## CPL

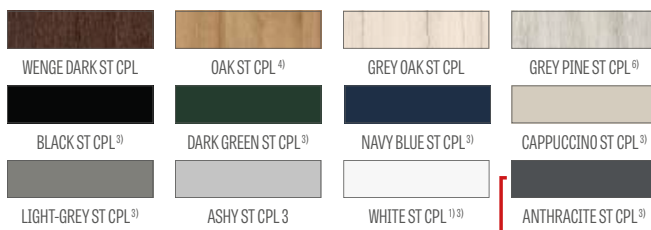

**NEW**

## AVAILABLE DOOR LEAF WIDTHS



## EXTRA CHARGES

factory pre-drilled through holes for handles (split handles) ordered together with the door leaf

enhanced airflow trim, ventilation undercut standard or mini (p. 137)

plastic woodgrain sleeves (4 pcs)

round and square metal sleeves (4 pcs); brushed nickel or patina finish in white and black

ventilation grille (only for door leaf widths of 80, 90, 100)

"100" rebated and non-rebated door leaf

VSG 221 laminated safety glass, plain on both sides

metal hinge casings in rebated door leaf (colour: brushed nickel, patina, glossy chrome, glossy brass, white and black)

drop down seal<sup>2)</sup>

can be replaced with a black or golden magnetic lock for non-rebated door leaves

can be changed to hinges and strike plate in black or gold for non-rebated door leaves

magnetic stop (buffer)<sup>2)</sup> (available in six colours p. 137)

glulam timber stiles<sup>4)</sup>

<sup>1)</sup> plain white facing imitating a painted surface

<sup>2)</sup> a stop will not allow a drop down seal and an enhanced airflow trim to be used, and vice versa

<sup>3)</sup> special AntiFinger coating to reduce dirt and fingerprints

<sup>4)</sup> glulam timber stiles covered with HDF and MDF boards available for WHITE PREMIUM, NATUR OAK PREMIUM, GRAPHITE ASH PREMIUM, GREY MAPLE PREMIUM, OAK ST CPL at extra charge

<sup>5)</sup> only for non-rebated door leaves

<sup>6)</sup> until stock lasts

# EPIMEDIUM

REBATED AND NON-REBATED INTERIOR STILE PANELLED DOORS



EPIMEDIUM 6, ASHY ST CPL facing layer, VSG black glass, handle: QUANTA FIT, black matt

WIDTH 80



EPIMEDIUM 1<sup>\*)</sup>



EPIMEDIUM 2<sup>\*)</sup>



EPIMEDIUM 3<sup>\*)</sup>



EPIMEDIUM 4<sup>\*)</sup>



EPIMEDIUM 6<sup>\*)</sup>

WIDTH 70



EPIMEDIUM 1<sup>\*)</sup>



EPIMEDIUM 2<sup>\*)</sup>



EPIMEDIUM 3<sup>\*)</sup>



EPIMEDIUM 4<sup>\*)</sup>



EPIMEDIUM 6<sup>\*)</sup>

<sup>\*)</sup> The pictures show only the EPIMEDIUM doors with 80 and 70 cm wide leaves.

The glazing to vertical bars ratio in the other width options differs considerably, which can be the key factor regarding the customer's product choice.

For the other width options go to [www.erkado.pl](http://www.erkado.pl)

EPIMEDIUM 6 in grey ST CPL facing layer with QUANTA FIT handle, black matt, VSG glass, black



NEW

## DESIGN

- rebated or non-rebated door leaf made in the STILE panelled technology
- MDF stiles and rails covered with the GREKO, PREMIUM, ST CPL facings or ST CPL laminate with the AntiFinger coating
- glued laminated timber stiles covered with HDF and MDF boards<sup>4)</sup>
- 4 mm thick HDF panels with GREKO, CPL or PREMIUM finish
- narrow, long crossbar of 22 mm
- optional door frame extension panels and a crossheads with pilasters are available for surcharge, pp. 139-141
- the door can be trimmed by a customer; go to p. 137 for details

## HARDWARE

- rebated door leaves: three silver 2-pin hinges adjusted horizontally
- three concealed hinges in a non-rebated leaf, silver (optionally black - subject to an additional charge); hinges supplied with and included in the price of the door frame
- lever tumbler lock in a rebated door leaf and a key-locked magnetic lock (lever tumbler lock as an option) in a non-rebated door leaf, thumb turn cylinder, economy, with a silver blockade; optionally, against an additional charge, a black or gold magnetic lock

## GLAZING

- tempered 4 mm glass, frosted or clear as a standard and, against an additional charge, laminated VSG 221 safety glass frosted or black plain on both sides
- possibility to change the glazing side to REVERSE (OBVERSE - standard glazing)
- depending on the leaf width, the glazing widths differ.  
Check at [www.erkado.pl](http://www.erkado.pl)

## AVAILABLE SOLUTIONS (pp. 142-153)

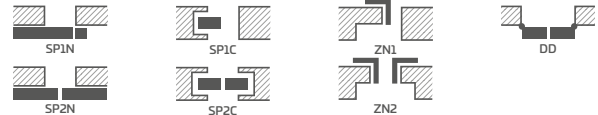

## GREKO

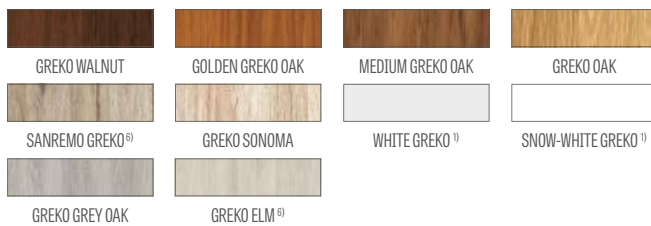

## PREMIUM

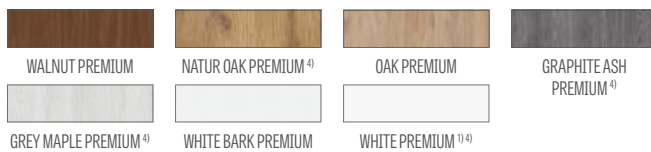

## CPL

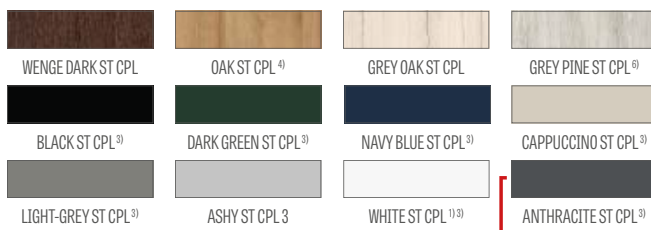

Glulam timber stiles<sup>4)</sup>

NEW

## AVAILABLE DOOR LEAF WIDTHS



## EXTRA CHARGES

factory pre-drilled through holes for handles (split handles) ordered together with the door leaf

enhanced airflow trim, ventilation undercut standard or mini (p. 137)

plastic woodgrain sleeves (4 pcs)

round and square metal sleeves (4 pcs); brushed nickel or patina finish in white and black

ventilation grille (only for door leaf widths of 80, 90, 100)

"100" rebated and non-rebated door leaf

VSG 221 laminated safety glass, plain on both sides

metal hinge casings in the rebated door leaf (brushed nickel, patina, polished chrome, polished brass, white and black)

drop down seal<sup>2)</sup>

can be replaced with a black or golden magnetic lock for non-rebated door leaves

can be changed to hinges and strike plate in black or gold for non-rebated door leaves

magnetic stop (buffer)<sup>2)</sup>  
(available in six colours p. 137)

glulam timber stiles<sup>4)</sup>

<sup>1)</sup> plain white facing imitating a painted surface

<sup>2)</sup> a stop will not allow a drop down seal and an enhanced airflow trim to be used, and vice versa

<sup>3)</sup> special **AntiFinger** coating to reduce dirt and fingerprints

<sup>4)</sup> glulam timber stiles covered with HDF and MDF boards available for WHITE PREMIUM, NATUR OAK PREMIUM, GRAPHITE ASH PREMIUM, GREY MAPLE PREMIUM, OAK ST CPL at extra charge

<sup>5)</sup> only for non-rebated door leaves

<sup>6)</sup> until stock lasts

# ARALIA NOLINA EWODIA

REBATED AND NON-REBATED INTERIOR STILE PANELLED DOORS



NOLINA 1, WHITE PREMIUM BARK facing layer, handle: RUMBA, antibacterial, black matt



ARALIA 1<sup>2)</sup>



NOLINA 1



EWODIA 1<sup>2)</sup>



EWODIA 2<sup>2)</sup>



EWODIA 4<sup>2)</sup>

NOLINA 1 in WHITE BARK PREMIUM facing layer with TOPAZ Stainless steel handle



## DESIGN

- rebated or non-rebated door leaf made in the STILE panelled technology
- MDF stiles and rails covered with the PREMIUM facing
- glued laminated timber stiles covered with HDF and MDF boards<sup>2)</sup>
- 16 mm thick HDF panels with PREMIUM facing layer (vertical grain direction)
- optional door frame extension panels and a crossheads with pilasters are available for surcharge, pp. 139-141
- the door can be trimmed by a customer, go to p. 137 for details

## HARDWARE

- rebated door leaves: three silver 2-pin hinges adjusted horizontally
- three concealed hinges in a non-rebated leaf, silver (optionally black - subject to an additional charge); hinges supplied with and included in the price of the door frame
- lever tumbler lock in a rebated door leaf and a key-locked magnetic lock (lever tumbler lock as an option) in a non-rebated door leaf, thumb turn cylinder, economy, with a silver blockade; optionally, against an additional charge, a black or gold magnetic lock

## GLAZING

- frosted Decormat glass, 4 mm, or custom-made frosted or black VSG 221 laminated safety glass, plain on both sides
- possibility to change the glazing side to REVERSE (standard glazing for OBERSE)

## AVAILABLE SOLUTIONS (pp. 142-153)

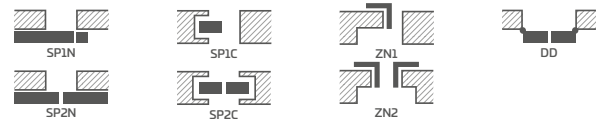

## AVAILABLE DOOR LEAF WIDTHS

60 70 80N<sup>3)</sup> 80 90 100

## EXTRA CHARGES

factory pre-drilled through holes for handles (split handles) ordered together with the door leaf

enhanced airflow trim, ventilation undercut standard or mini (p. 137)

plastic woodgrain sleeves (4 pcs)

round and square metal sleeves (4 pcs); brushed nickel or patina finish in white and black

ventilation grille (only for door leaf widths of 80, 90, 100)

"100" rebated and non-rebated door leaf

VSG 221 laminated safety glass, plain on both sides

metal hinge casings in rebated door leaf

(colour: brushed nickel, patina, glossy chrome, glossy brass, white and black)

drop down seal<sup>1)</sup>

can be replaced with a black or golden magnetic lock for non-rebated door leaves

can be changed to hinges and strike plate in black or gold for non-rebated door leaves

magnetic stop (buffer)<sup>1)</sup>

(available in six colours p. 137)

glulam timber stiles<sup>2)</sup>

## PREMIUM



Glulam timber stiles<sup>2)</sup>

<sup>1)</sup> a stop will not allow a drop down seal and an enhanced airflow trim to be used, and vice versa

<sup>2)</sup> glulam timber stiles covered with HDF and MDF boards available for an extra charge in ARALIA 1, EWODIA 1, 2, 4 models for NATUR OAK PREMIUM, GRAPHITE ASH PREMIUM, GRAPHITE MAPLE PREMIUM

<sup>3)</sup> only for non-rebated door leaves

# POWOJNIK

REBATED AND NON-REBATED INTERIOR STILE PANELLED DOORS



POWOJNIK 1, NAVY BLUE ST CPL facing layer, MOON R SLIM handle, glossy brass



POWOJNIK 1



POWOJNIK 2



POWOJNIK 3



POWOJNIK 4



POWOJNIK 5

POWOJNIK 3 m NAVY BLUE ST CPL facing layer with MOON R SLIM handle, glossy brass



## DESIGN

- rebated or non-rebated door leaf made in the STILE panelled technology
- MDF stiles and rails covered with the PREMIUM, ST CPL facings or ST CPL laminate with the AntiFinger coating
- glued laminated timber stiles covered with HDF and MDF boards<sup>4)</sup>
- 4 mm thick HDF panels with CPL or PREMIUM facing
- central crossbars of 22 mm in thickness and a very wide upper and bottom crossbar of 35 mm
- optional door frame extension panels and a crossheads with pilasters are available for surcharge, pp. 139-141
- the door can be trimmed by a customer; go to p. 137 for details

## HARDWARE

- rebated door leaves: three silver 2-pin hinges adjusted horizontally
- three concealed hinges in a non-rebated leaf, silver (optionally black - subject to an additional charge); hinges supplied with and included in the price of the door frame
- lever tumbler lock in a rebated door leaf and a key-locked magnetic lock (lever tumbler lock as an option) in a non-rebated door leaf, thumb turn cylinder, economy, with a silver blockade; optionally, against an additional charge, a black or gold magnetic lock

## GLAZING

- tempered 4 mm glass, frosted or clear as a standard and, against an additional charge, laminated VSG 221 safety glass frosted or black plain on both sides
- possibility to change the glazing side to REVERSE (OBVERSE - standard glazing)

## AVAILABLE SOLUTIONS (pp. 142-153)

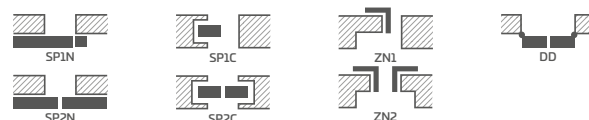

## AVAILABLE DOOR LEAF WIDTHS

60 70 80N<sup>5)</sup> 80 90 100

## EXTRA CHARGES

factory pre-drilled through holes for handles (split handles) ordered together with the door leaf

enhanced airflow trim, ventilation undercut standard or mini (p. 137)

plastic woodgrain sleeves (4 pcs)

round and square metal sleeves (4 pcs); brushed nickel or patina finish in white and black

ventilation grille (only for door leaf widths of 80, 90, 100)

"100" rebated and non-rebated door leaf

VSG 221 laminated safety glass, plain on both sides

metal hinge casings in rebated door leaf

(colour: brushed nickel, patina, glossy chrome, glossy brass, white and black)

drop down seal<sup>2)</sup>

can be replaced with a black or golden magnetic lock for non-rebated door leaves

can be changed to hinges and strike plate in black or gold for non-rebated door leaves

magnetic stop (buffer)<sup>2)</sup>

(available in six colours p. 137)

glulam timber stiles<sup>4)</sup>

## PREMIUM



## CPL

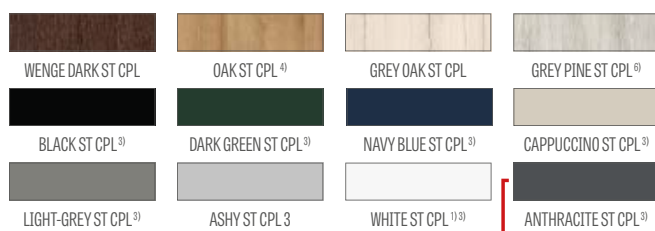

**NEW**



Glulam timber stiles<sup>4)</sup>

<sup>1)</sup> plain white facing imitating a painted surface

<sup>2)</sup> a stop will not allow a drop down seal and an enhanced airflow trim to be used, and vice versa

<sup>3)</sup> special **AntiFinger** coating to reduce dirt and fingerprints

<sup>4)</sup> glulam timber stiles covered with HDF and MDF boards available for WHITE PREMIUM, NATUR OAK PREMIUM, GRAPHITE ASH PREMIUM, GREY MAPLE PREMIUM, OAK ST CPL at extra charge

<sup>5)</sup> only for non-rebated door leaves

<sup>6)</sup> until stock lasts

# JUKA

REBATED AND NON-REBATED INTERIOR STILE PANELLED DOORS



JUKA 1, DARK GREEN ST CPL facing layer, BELLA SLIM handle, glossy brass



JUKA 1



JUKA 2



JUKA 3



JUKA 4



JUKA 5



JUKA 6



JUKA 7



JUKA 8

JUKA 1 in DARK GREEN ST CPL facing layer with BELLA SLIM handle, glossy brass



**DESIGN**

- rebated or non-rebated door leaf made in the STILE panelled technology
- MDF stiles and rails covered with the GREKO, PREMIUM, ST CPL facings or ST CPL laminate with the AntiFinger coating
- glued laminated timber stiles covered with HDF and MDF boards<sup>4)</sup>
- 4 mm thick HDF panels with GREKO, CPL or PREMIUM finish
- optional door frame extension panels and a crossheads with pilasters are available for surcharge, pp. 139-141
- the door can be trimmed by a customer; go to p. 137 for details

**HARDWARE**

- rebated door leaves: three silver 2-pin hinges adjusted horizontally
- three concealed hinges in a non-rebated leaf, silver (optionally black - subject to an additional charge); hinges supplied with and included in the price of the door frame
- lever tumbler lock in a rebated door leaf and a key-locked magnetic lock (lever tumbler lock as an option) in a non-rebated door leaf, thumb turn cylinder, economy, with a silver blockade; optionally, against an additional charge, a black or gold magnetic lock

**GLAZING**

- tempered 4 mm glass, frosted or clear as a standard and, against an additional charge, laminated VSG 221 safety glass frosted or black plain on both sides
- possibility to change the glazing side to REVERSE (standard glazing for OBVERSE)

**AVAILABLE SOLUTIONS** (pp. 142-153)

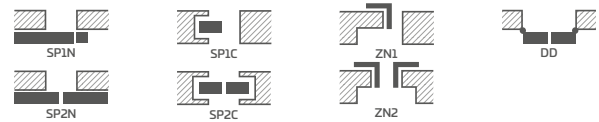

**AVAILABLE DOOR LEAF WIDTHS**



**EXTRA CHARGES**

factory pre-drilled through holes for handles (split handles) ordered together with the door leaf

enhanced airflow trim, ventilation undercut standard or mini (p. 137)

plastic woodgrain sleeves (4 pcs)

round and square metal sleeves (4 pcs); brushed nickel or patina finish in white and black

ventilation grille (only for door leaf widths of 80, 90, 100)

"100" rebated and non-rebated door leaf

VSG 221 laminated safety glass, plain on both sides

metal hinge casings in the rebated door leaf (brushed nickel, patina, polished chrome, polished brass, white and black)

drop down seal<sup>2)</sup>

can be replaced with a black or golden magnetic lock for non-rebated door leaves

can be changed to hinges and strike plate in black or gold for non-rebated door leaves

magnetic stop (buffer)<sup>2)</sup>  
(available in six colours p. 137)

glulam timber stiles<sup>4)</sup>

**GREKO**

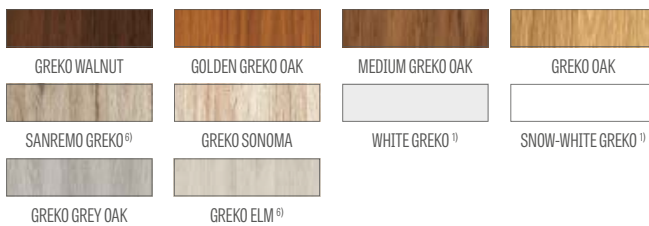

**PREMIUM**

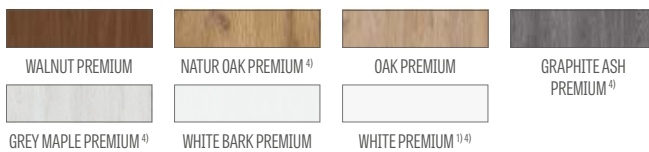

**CPL**

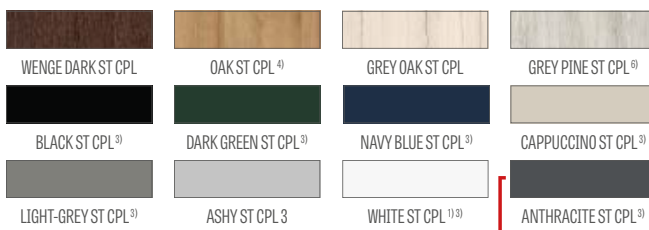

**NEW**



Glulam timber stiles<sup>4)</sup>

<sup>1)</sup> plain white facing imitating a painted surface

<sup>2)</sup> a stop will not allow a drop down seal and an enhanced airflow trim to be used, and vice versa

<sup>3)</sup> special **AntiFinger** coating to reduce dirt and fingerprints

<sup>4)</sup> glulam timber stiles covered with HDF and MDF boards available for WHITE PREMIUM, NATUR OAK PREMIUM, GRAPHITE ASH PREMIUM, GREY MAPLE PREMIUM, OAK ST CPL at extra charge

<sup>5)</sup> only for non-rebated door leaves

<sup>6)</sup> until stock lasts

# FORSYCJA

REBATED AND NON-REBATED INTERIOR STILE PANELLED DOORS



FORSYCJA 1, leaf with WHITE GREKO facing layer, BELLA SLIM handle, black matt



FORSYCJA 1



FORSYCJA 2



FORSYCJA 3



FORSYCJA 4



FORSYCJA 5



FORSYCJA 6



FORSYCJA 7



FORSYCJA 8

FORSYCIA 4 with WHITE GREKO foil and a black matt CUBE handle



**DESIGN**

- rebated or non-rebated door leaf made in the STILE panelled technology
- MDF stiles and rails covered with the GREKO, PREMIUM, ST CPL facings or ST CPL laminate with the AntiFinger coating
- glued laminated timber stiles covered with HDF and MDF boards<sup>4)</sup>
- 4 mm thick HDF panels with GREKO, CPL or PREMIUM finish
- optional door frame extension panels and a crossheads with pilasters are available for surcharge, pp. 139-141
- the door can be trimmed by a customer, go to p. 137 for details

**HARDWARE**

- rebated door leaves: three silver 2-pin hinges adjusted horizontally
- three concealed hinges in a non-rebated leaf, silver (optionally black - subject to an additional charge); hinges supplied with and included in the price of the door frame
- lever tumbler lock in a rebated door leaf and a key-locked magnetic lock (lever tumbler lock as an option) in a non-rebated door leaf, thumb turn cylinder, economy, with a silver blockade; optionally, against an additional charge, a black or gold magnetic lock

**GLAZING**

- tempered 4 mm glass, frosted or clear as a standard and, against an additional charge, laminated VSG 221 safety glass frosted or black plain on both sides
- possibility to change the glazing side to REVERSE (standard glazing for OBERSE)

**AVAILABLE SOLUTIONS** (pp. 142-153)

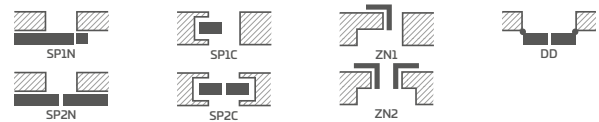

**AVAILABLE DOOR LEAF WIDTHS**



**GREKO**

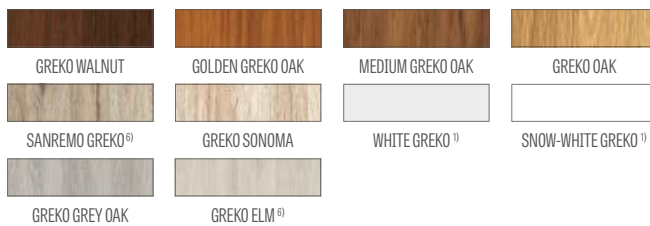

**PREMIUM**

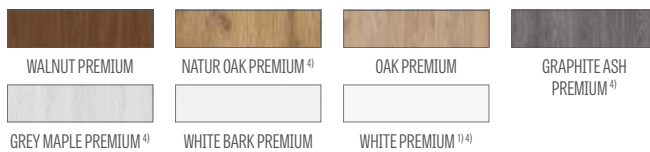

**CPL**

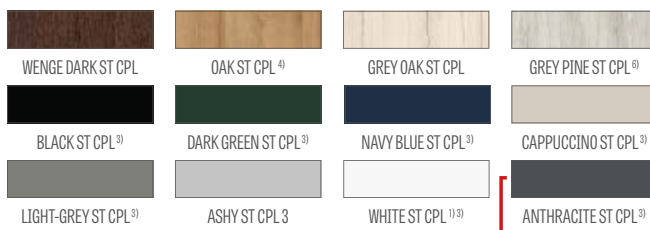

**NEW**



**EXTRA CHARGES**

factory pre-drilled through holes for handles (split handles) ordered together with the door leaf

enhanced airflow trim, ventilation undercut standard or mini (p. 137)

plastic woodgrain sleeves (4 pcs)

round and square metal sleeves (4 pcs); brushed nickel or patina finish in white and black

ventilation grille (only for door leaf widths of 80, 90, 100)

"100" rebated and non-rebated door leaf

VSG 221 laminated safety glass, plain on both sides

metal hinge casings in the rebated door leaf (brushed nickel, patina, polished chrome, polished brass, white and black)

drop down seal<sup>2)</sup>

can be replaced with a black or golden magnetic lock for non-rebated door leaves

can be changed to hinges and strike plate in black or gold for non-rebated door leaves

magnetic stop (buffer)<sup>2)</sup>  
(available in six colours p. 137)

glulam timber stiles<sup>4)</sup>

<sup>1)</sup> plain white facing imitating a painted surface

<sup>2)</sup> a stop will not allow a drop down seal and an enhanced airflow trim to be used, and vice versa

<sup>3)</sup> special **AntiFinger** coating to reduce dirt and fingerprints

<sup>4)</sup> glulam timber stiles covered with HDF and MDF boards available for WHITE PREMIUM, NATUR OAK PREMIUM, GRAPHITE ASH PREMIUM, GREY MAPLE PREMIUM, OAK ST CPL at extra charge

<sup>5)</sup> only for non-rebated door leaves

<sup>6)</sup> until stock lasts

# LAWENDA

REBATED AND NON-REBATED INTERIOR STILE PANELLED DOORS



LAWENDA 7, facing layer: GREKO OAK, DECO handle



LAWENDA 1



LAWENDA 2



LAWENDA 3



LAWENDA 4



LAWENDA 5



LAWENDA 6



LAWENDA 7



LAWENDA 8



LAWENDA 9

LAWENDA 1 with GREKO OAK foil and a DECO handle



**DESIGN**

- rebated or non-rebated door leaf made in the STILE panelled technology
- MDF stiles and rails covered with the GREKO, PREMIUM, ST CPL facings or ST CPL laminate with the AntiFinger coating
- glued laminated timber stiles covered with HDF and MDF boards<sup>4)</sup>
- 4 mm thick HDF panels with GREKO, CPL or PREMIUM finish
- optional door frame extension panels and a crossheads with pilasters are available for surcharge, pp. 139-141
- the door can be trimmed by a customer, go to p. 137 for details

**HARDWARE**

- rebated door leaves: three silver 2-pin hinges adjusted horizontally
- three concealed hinges in a non-rebated leaf, silver (optionally black - subject to an additional charge); hinges supplied with and included in the price of the door frame
- lever tumbler lock in a rebated door leaf and a key-locked magnetic lock (lever tumbler lock as an option) in a non-rebated door leaf, thumb turn cylinder, economy, with a silver blockade; optionally, against an additional charge, a black or gold magnetic lock

**GLAZING**

- tempered 4 mm glass, frosted or clear as a standard and, against an additional charge, laminated VSG 221 safety glass frosted or black plain on both sides
- possibility to change the glazing side to REVERSE (standard glazing for OBERVERSE)

**AVAILABLE SOLUTIONS** (pp. 142-153)

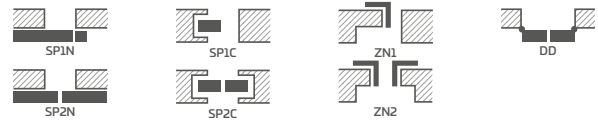

**AVAILABLE DOOR LEAF WIDTHS**



**EXTRA CHARGES**

factory pre-drilled through holes for handles (split handles) ordered together with the door leaf

enhanced airflow trim, ventilation undercut standard or mini (p. 137)

plastic woodgrain sleeves (4 pcs)

round and square metal sleeves (4 pcs); brushed nickel or patina finish in white and black

ventilation grille (only for door leaf widths of 80, 90, 100)

"100" rebated and non-rebated door leaf

VSG 221 laminated safety glass, plain on both sides

metal hinge casings in the rebated door leaf (brushed nickel, patina, polished chrome, polished brass, white and black)

drop down seal<sup>2)</sup>

can be replaced with a black or golden magnetic lock for non-rebated door leaves

can be changed to hinges and strike plate in black or gold for non-rebated door leaves

magnetic stop (buffer)<sup>2)</sup>  
(available in six colours p. 137)

glulam timber stiles<sup>4)</sup>

**GREKO**

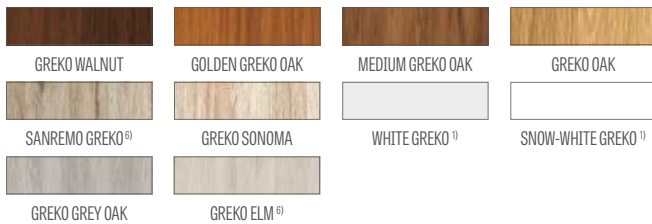

**PREMIUM**

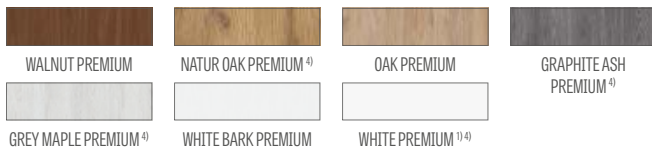

**CPL**

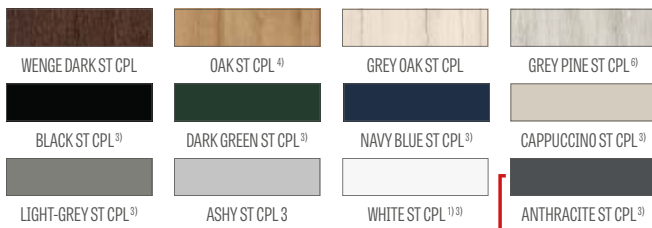

**NEW**



Glulam timber stiles<sup>4)</sup>

<sup>1)</sup> plain white facing imitating a painted surface

<sup>2)</sup> a stop will not allow a drop down seal and an enhanced airflow trim to be used, and vice versa

<sup>3)</sup> special **AntiFinger** coating to reduce dirt and fingerprints

<sup>4)</sup> glulam timber stiles covered with HDF and MDF boards available for WHITE PREMIUM, NATUR OAK PREMIUM, GRAPHITE ASH PREMIUM, GREY MAPLE PREMIUM, OAK ST CPL at extra charge

<sup>5)</sup> only for non-rebated door leaves

<sup>6)</sup> until stock lasts

# IRYS

REBATED AND NON-REBATED INTERIOR STILE PANELLED DOORS



IRYS 1, WHITE ST CPL facing layer, handle: CUBE, black matt



IRYS 1



IRYS 2



IRYS 3



IRYS 4



IRYS 5



IRYS 6



IRYS 7



IRYS 8

IRYS 1 in ASHY ST CPL facing layer with QUANTA FT handle, black matt



## DESIGN

- rebated or non-rebated door leaf made in the STILE panelled technology
- MDF stiles and rails covered with the GREKO, PREMIUM, ST CPL facings or ST CPL laminate with the AntiFinger coating
- glued laminated timber stiles covered with HDF and MDF boards<sup>4)</sup>
- 4 mm thick HDF panels with GREKO, CPL or PREMIUM finish
- optional door frame extension panels and a crossheads with pilasters are available for surcharge, pp. 139-141
- the door can be trimmed by a customer, go to p. 137 for details

## HARDWARE

- rebated door leaves: three silver 2-pin hinges adjusted horizontally
- three concealed hinges in a non-rebated leaf, silver (optionally black - subject to an additional charge); hinges supplied with and included in the price of the door frame
- lever tumbler lock in a rebated door leaf and a key-locked magnetic lock (lever tumbler lock as an option) in a non-rebated door leaf, thumb turn cylinder, economy, with a silver blockade; optionally, against an additional charge, a black or gold magnetic lock

## GLAZING

- tempered 4 mm glass, frosted or clear as a standard and, against an additional charge, laminated VSG 221 safety glass frosted or black plain on both sides
- possibility to change the glazing side to REVERSE (OBSERVE - standard glazing)

## AVAILABLE SOLUTIONS (pp. 142-153)

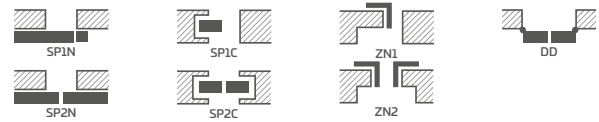

## AVAILABLE DOOR LEAF WIDTHS

60 70 80N<sup>5)</sup> 80 90 100

### GREKO

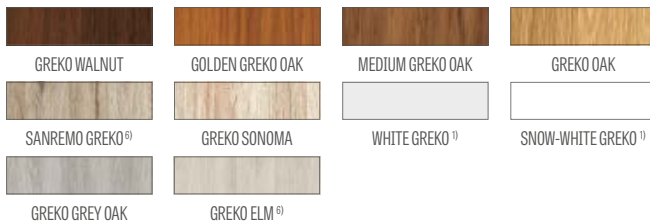

### PREMIUM

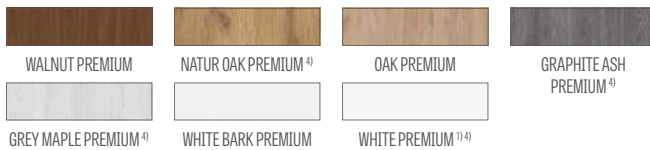

### CPL

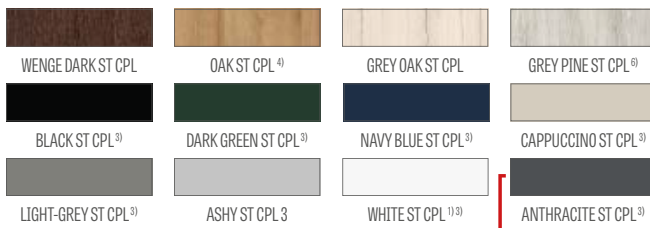

**NEW**



Glulam timber stiles<sup>4)</sup>

## EXTRA CHARGES

factory pre-drilled through holes for handles (split handles) ordered together with the door leaf

enhanced airflow trim, ventilation undercut standard or mini (p. 137)

plastic woodgrain sleeves (4 pcs)

round and square metal sleeves (4 pcs); brushed nickel or patina finish in white and black

ventilation grille (only for door leaf widths of 80, 90, 100)

"100" rebated and non-rebated door leaf

VSG 221 laminated safety glass, plain on both sides

metal hinge casings in rebated door leaf

(colour: brushed nickel, patina, glossy chrome, glossy brass, white and black)

drop down seal<sup>2)</sup>

can be replaced with a black or golden magnetic lock for non-rebated door leaves

can be changed to hinges and strike plate in black or gold for non-rebated door leaves

magnetic stop (buffer)<sup>2)</sup>

(available in six colours p. 137)

glulam timber stiles<sup>4)</sup>

<sup>1)</sup> plain white facing imitating a painted surface

<sup>2)</sup> a stop will not allow a drop down seal and an enhanced airflow trim to be used, and vice versa

<sup>3)</sup> special **AntiFinger** coating to reduce dirt and fingerprints

<sup>4)</sup> glulam timber stiles covered with HDF and MDF boards available for WHITE PREMIUM, NATUR OAK PREMIUM, GRAPHITE ASH PREMIUM, GREY MAPLE PREMIUM, OAK ST CPL at extra charge

<sup>5)</sup> only for non-rebated door leaves

<sup>6)</sup> until stock lasts

# DAGLEZJA

REBATED AND NON-REBATED INTERIOR STILE PANELLED DOORS



DAGLEZJA 1, ANTHRACITE ST CPL facing layer; CUBE handle, brushed chrome, matt



DAGLEZJA 1



DAGLEZJA 2



DAGLEZJA 3



DAGLEZJA 4



DAGLEZJA 5



DAGLEZJA 6



DAGLEZJA 7



DAGLEZJA 8

DAGLEZJAG with ANTHRACITE ST CPL laminate and a brushed chrome CUBE handle, matt



## DESIGN

- rebated or non-rebated door leaf made in the STILE panelled technology
- MDF stiles and rails covered with the GREKO, PREMIUM, ST CPL facings or ST CPL laminate with the AntiFinger coating
- glued laminated timber stiles covered with HDF and MDF boards<sup>4)</sup>
- 4 mm thick HDF panels with GREKO, CPL or PREMIUM finish
- very wide crossbar
- optional door frame extension panels and a crossheads with pilasters are available for surcharge, pp. 139-141
- the door can be trimmed by a customer; go to p. 137 for details

## HARDWARE

- rebated door leaves: three silver 2-pin hinges adjusted horizontally
- three concealed hinges in a non-rebated leaf, silver (optionally black - subject to an additional charge); hinges supplied with and included in the price of the door frame
- lever tumbler lock in a rebated door leaf and a key-locked magnetic lock (lever tumbler lock as an option) in a non-rebated door leaf, thumb turn cylinder, economy, with a silver blockade; optionally, against an additional charge, a black or gold magnetic lock

## GLAZING

- tempered 4 mm glass, frosted or clear as a standard and, against an additional charge, laminated VSG 221 safety glass frosted or black plain on both sides
- possibility to change the glazing side to REVERSE (OBVERSE - standard glazing)

## AVAILABLE SOLUTIONS (pp. 142-153)

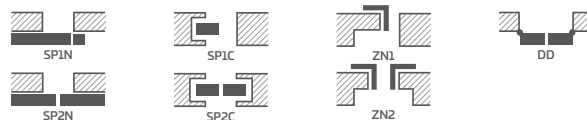

## AVAILABLE DOOR LEAF WIDTHS

60 70 80N<sup>5)</sup> 80 90 100

### GREKO

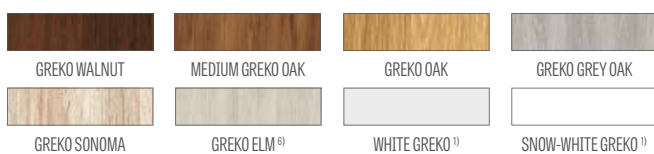

### PREMIUM

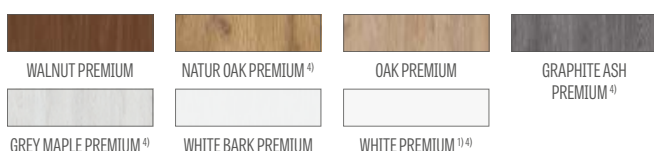

### CPL

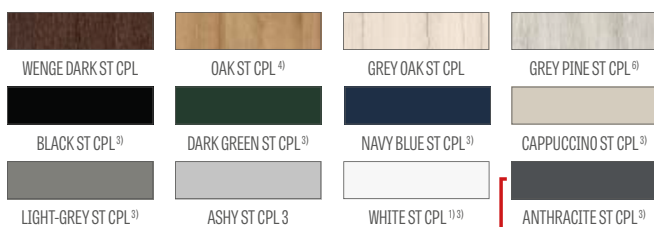

**NEW**



Glulam timber stiles<sup>4)</sup>

## EXTRA CHARGES

factory pre-drilled through holes for handles (split handles) ordered together with the door leaf

enhanced airflow trim, ventilation undercut standard or mini (p. 137)

plastic woodgrain sleeves (4 pcs)

round and square metal sleeves (4 pcs); brushed nickel or patina finish in white and black

ventilation grille (only for door leaf widths of 80, 90, 100)

"100" rebated and non-rebated door leaf

VSG 221 laminated safety glass, plain on both sides

metal hinge casings in rebated door leaf

(colour: brushed nickel, patina, glossy chrome, glossy brass, white and black)

drop down seal<sup>2)</sup>

can be replaced with a black or golden magnetic lock for non-rebated door leaves

can be changed to hinges and strike plate in black or gold for non-rebated door leaves

magnetic stop (buffer)<sup>2)</sup>

(available in six colours p. 137)

glulam timber stiles<sup>4)</sup>

<sup>1)</sup> plain white facing imitating a painted surface

<sup>2)</sup> a stop will not allow a drop down seal and an enhanced airflow trim to be used, and vice versa

<sup>3)</sup> special **AntiFinger** coating to reduce dirt and fingerprints

<sup>4)</sup> glulam timber stiles covered with HDF and MDF boards available for WHITE PREMIUM, NATUR OAK PREMIUM, GRAPHITE ASH PREMIUM, GREY MAPLE PREMIUM, OAK ST CPL at extra charge

<sup>5)</sup> only for non-rebated door leaves

<sup>6)</sup> until stock lasts

# DEBECJA

REBATED AND NON-REBATED INTERIOR STILE PANELLED DOORS



DEBECJA 1, CAPPUCCINO ST CPL facing layer; handle: BELLA SLIM, round, glossy brass



DEBECJA 1



DEBECJA 2



DEBECJA 3



DEBECJA 4



DEBECJA 5



DEBECJA 6



DEBECJA 7

DEBECJA 7 in CAPPUCCINO ST CPL facing layer with BELLA SLIM round handle, glossy brass



## DESIGN

- rebated or non-rebated door leaf made in the STILE panelled technology
- MDF stiles and rails covered with the GREKO, PREMIUM, ST CPL facings or ST CPL laminate with the AntiFinger coating
- glued laminated timber stiles covered with HDF and MDF boards<sup>4)</sup>
- 4 mm thick HDF panels with GREKO, CPL or PREMIUM finish
- very wide crossbar
- optional door frame extension panels and a crossheads with pilasters are available for surcharge, pp. 139-141
- the door can be trimmed by a customer; go to p. 137 for details

## HARDWARE

- rebated door leaves: three silver 2-pin hinges adjusted horizontally
- three concealed hinges in a non-rebated leaf, silver (optionally black - subject to an additional charge); hinges supplied with and included in the price of the door frame
- lever tumbler lock in a rebated door leaf and a key-locked magnetic lock (lever tumbler lock as an option) in a non-rebated door leaf, thumb turn cylinder, economy, with a silver blockade; optionally, against an additional charge, a black or gold magnetic lock

## GLAZING

- tempered 4 mm glass, frosted or clear as a standard and, against an additional charge, laminated VSG 221 safety glass frosted or black plain on both sides
- possibility to change the glazing side to REVERSE (standard glazing for OBVERSE)

## AVAILABLE SOLUTIONS (pp. 142-153)

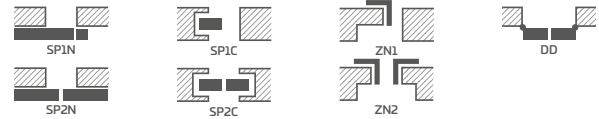

## AVAILABLE DOOR LEAF WIDTHS

60 70 80N<sup>5)</sup> 80 90 100

### GREKO

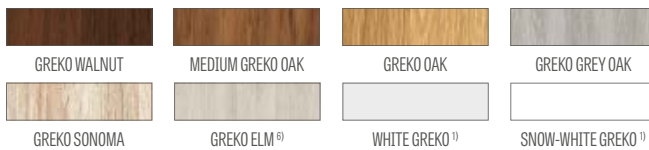

### PREMIUM

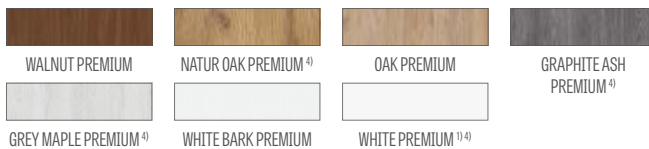

### CPL

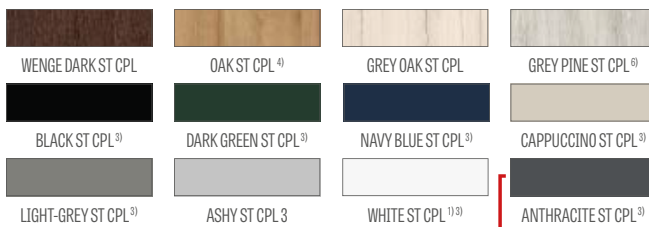

**NEW**



Glulam timber stiles<sup>4)</sup>

## EXTRA CHARGES

factory pre-drilled through holes for handles (split handles) ordered together with the door leaf

enhanced airflow trim, ventilation undercut standard or mini (p. 137)

plastic woodgrain sleeves (4 pcs)

round and square metal sleeves (4 pcs); brushed nickel or patina finish in white and black

ventilation grille (only for door leaf widths of 80, 90, 100)

"100" rebated and non-rebated door leaf

VSG 221 laminated safety glass, plain on both sides

metal hinge casings in rebated door leaf

(colour: brushed nickel, patina, glossy chrome, glossy brass, white and black)

drop down seal<sup>2)</sup>

can be replaced with a black or golden magnetic lock for non-rebated door leaves

can be changed to hinges and strike plate in black or gold for non-rebated door leaves

magnetic stop (buffer)<sup>2)</sup>

(available in six colours p. 137)

glulam timber stiles<sup>4)</sup>

<sup>1)</sup> plain white facing imitating a painted surface

<sup>2)</sup> a stop will not allow a drop down seal and an enhanced airflow trim to be used, and vice versa

<sup>3)</sup> special **AntiFinger** coating to reduce dirt and fingerprints

<sup>4)</sup> glulam timber stiles covered with HDF and MDF boards available for WHITE PREMIUM, NATUR OAK PREMIUM, GRAPHITE ASH PREMIUM, GREY MAPLE PREMIUM, OAK ST CPL at extra charge

<sup>5)</sup> only for non-rebated door leaves

<sup>6)</sup> until stock lasts

# SURMIA

REBATED AND NON-REBATED INTERIOR STILE PANELLED DOORS



SURMIA 1, WENGE DARK ST CPL facing layer; CUBE handle, brushed chrome, matt



SURMIA 1



SURMIA 2



SURMIA 3



SURMIA 4

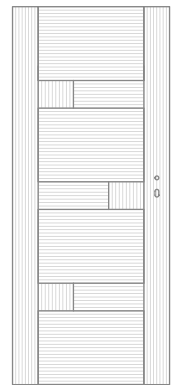

GRAIN PATTERN \*)

SURMIA 4 in WENGE DARK ST CPL facing layer with CUBE handle, brushed chrome, matt



## DESIGN

- rebated or non-rebated door leaf made in the STILE panelled technology
- MDF stiles and rails covered with the PREMIUM, ST CPL facings or ST CPL laminate with the AntiFinger coating
- glued laminated timber stiles covered with HDF and MDF boards<sup>4)</sup>
- 22 mm and 4 mm thick HDF panels with CPL or PREMIUM finish
- 35 mm thick, very wide crossbar
- optional door frame extension panels and a crossheads with pilasters are available for surcharge, pp. 139-141
- the door can be trimmed by a customer; go to p. 137 for details

## HARDWARE

- rebated door leaves: three silver 2-pin hinges adjusted horizontally
- three concealed hinges in a non-rebated leaf, silver (optionally black - subject to an additional charge); hinges supplied with and included in the price of the door frame
- lever tumbler lock in a rebated door leaf and a key-locked magnetic lock (lever tumbler lock as an option) in a non-rebated door leaf, thumb turn cylinder, economy, with a silver blockade; optionally, against an additional charge, a black or gold magnetic lock

## GLAZING

- tempered 4 mm glass, frosted or clear as a standard and, against an additional charge, laminated VSG 221 safety glass frosted or black plain on both sides
- possibility to change the glazing side to REVERSE (standard glazing for OBVERSE)

## AVAILABLE SOLUTIONS (pp. 142-153)

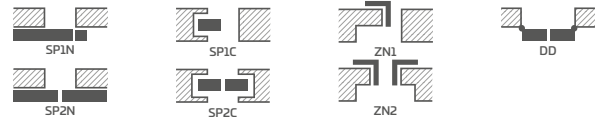

## AVAILABLE DOOR LEAF WIDTHS

60 70 80N<sup>5)</sup> 80 90 100

## EXTRA CHARGES

factory pre-drilled through holes for handles (split handles) ordered together with the door leaf

enhanced airflow trim, ventilation undercut standard or mini (p. 137)

plastic woodgrain sleeves (4 pcs)

round and square metal sleeves (4 pcs); brushed nickel or patina finish in white and black  
ventilation grille (only for door leaf widths of 80, 90, 100)

"100" rebated and non-rebated door leaf

VSG 221 laminated safety glass, plain on both sides

metal hinge casings in rebated door leaf  
(colour: brushed nickel, patina, glossy chrome, glossy brass, white and black)

drop down seal<sup>2)</sup>

can be replaced with a black or golden magnetic lock for non-rebated door leaves

can be changed to hinges and strike plate in black or gold for non-rebated door leaves

magnetic stop (buffer)<sup>2)</sup>  
(available in six colours p. 137)

glulam timber stiles<sup>4)</sup>

## PREMIUM

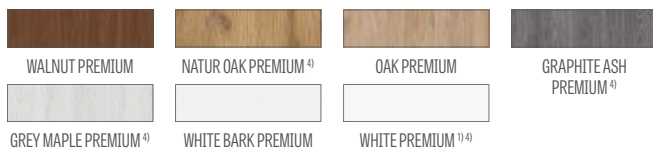

## CPL

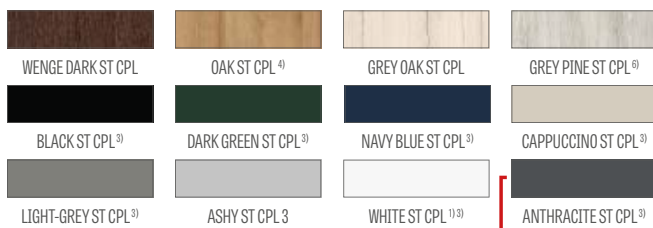

**NEW**



Glulam timber stiles<sup>4)</sup>

<sup>1)</sup> plain white facing imitating a painted surface

<sup>2)</sup> a stop will not allow a drop down seal and an enhanced airflow trim to be used, and vice versa

<sup>3)</sup> special AntiFinger coating to reduce dirt and fingerprints

<sup>4)</sup> glulam timber stiles covered with HDF and MDF boards available for WHITE PREMIUM, NATUR OAK PREMIUM, GRAPHITE ASH PREMIUM, GREY MAPLE PREMIUM, OAK ST CPL at extra charge

<sup>5)</sup> only for non-rebated door leaves

<sup>6)</sup> until stock lasts

# BERBERYS

REBATED AND NON-REBATED INTERIOR STILE PANELLED DOORS



BERBERYS 1, WALNUT PREMIUM, handle: CUBE, brushed chrome, matt



BERBERYS 1



BERBERYS 2



BERBERYS 3



BERBERYS 4



BERBERYS 5



BERBERYS 6



BERBERYS 7



BERBERYS 8

BERBERYS 1 in WALNUT PREMIUM facing layer with brushed chrome CUBE handle, matt



## DESIGN

- rebated or non-rebated door leaf made in the STILE panelled technology
- MDF stiles and rails covered with the GREKO, PREMIUM, ST CPL facings or ST CPL laminate with the AntiFinger coating
- glued laminated timber stiles covered with HDF and MDF boards<sup>4)</sup>
- 4 mm thick HDF panels with GREKO, CPL or PREMIUM finish
- brushed aluminium insert profiles
- optional door frame extension panels and a crossheads with pilasters are available for surcharge, pp. 139-141
- the door can be trimmed by a customer; go to p. 137 for details

## HARDWARE

- rebated door leaves: three silver 2-pin hinges adjusted horizontally
- three concealed hinges in a non-rebated leaf, silver (optionally black - subject to an additional charge); hinges supplied with and included in the price of the door frame
- lever tumbler lock in a rebated door leaf and a key-locked magnetic lock (lever tumbler lock as an option) in a non-rebated door leaf, thumb turn cylinder, economy, with a silver blockade; optionally, against an additional charge, a black or gold magnetic lock

## GLAZING

- tempered 4 mm glass, frosted or clear as a standard and, against an additional charge, laminated VSG 221 safety glass frosted or black plain on both sides
- possibility to change the glazing side to REVERSE (standard glazing for OBVERSE)

## AVAILABLE SOLUTIONS (pp. 142-153)

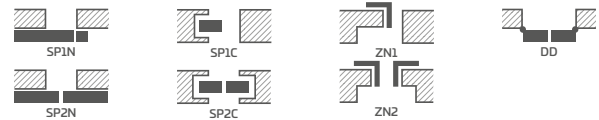

## GREKO

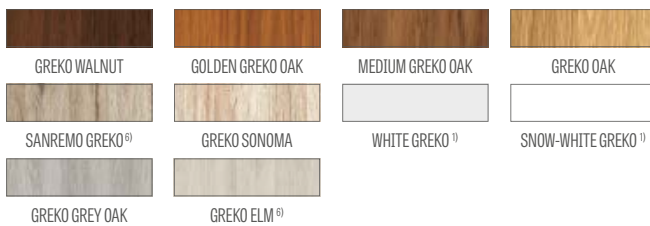

## PREMIUM

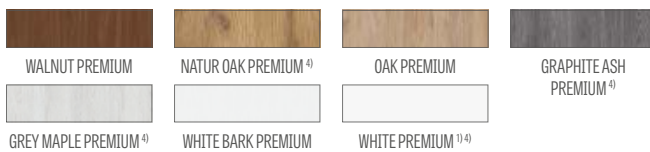

## CPL

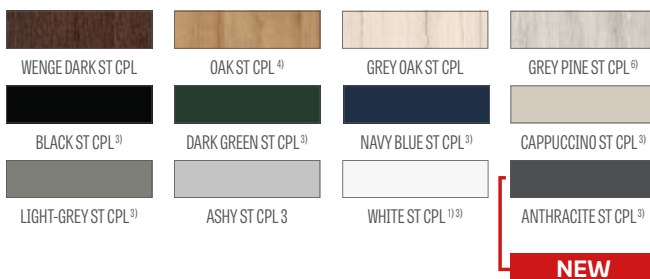

NEW



Glulam timber stiles<sup>4)</sup>

## AVAILABLE DOOR LEAF WIDTHS

60 70 80N<sup>5)</sup> 80 90 100

## EXTRA CHARGES

factory pre-drilled through holes for handles (split handles) ordered together with the door leaf

enhanced airflow trim, ventilation undercut standard or mini (p. 137)

plastic woodgrain sleeves (4 pcs)

round and square metal sleeves (4 pcs); brushed nickel or patina finish in white and black

ventilation grille (only for door leaf widths of 80, 90, 100)

"100" rebated and non-rebated door leaf

VSG 221 laminated safety glass, plain on both sides

metal hinge casings in rebated door leaf

(colour: brushed nickel, patina, glossy chrome, glossy brass, white and black)

drop down seal<sup>2)</sup>

can be replaced with a black or golden magnetic lock for non-rebated door leaves

can be changed to hinges and strike plate in black or gold for non-rebated door leaves

magnetic stop (buffer)<sup>2)</sup>

(available in six colours p. 137)

glulam timber stiles<sup>4)</sup>

<sup>1)</sup> plain white facing imitating a painted surface

<sup>2)</sup> a stop will not allow a drop down seal and an enhanced airflow trim to be used, and vice versa

<sup>3)</sup> special AntiFinger coating to reduce dirt and fingerprints

<sup>4)</sup> glulam timber stiles covered with HDF and MDF boards available for WHITE PREMIUM, NATUR OAK PREMIUM, GRAPHITE ASH PREMIUM, GREY MAPLE PREMIUM, OAK ST CPL at extra charge

<sup>5)</sup> only for non-rebated door leaves

<sup>6)</sup> until stock lasts

# FLOKS

REBATED AND NON-REBATED INTERIOR STILE PANELLED DOORS



FLOKS 8, facing layer: OAK ST CPL, brushed chrome CUBE handle, matt



FLOKS 1



FLOKS 2



FLOKS 3



FLOKS 4



FLOKS 5



FLOKS 6



FLOKS 7



FLOKS 8

FLOKS 1 in OAK ST CPL facing layer with matt brushed chrome CUBE handle



## DESIGN

- rebated or non-rebated door leaf made in the STILE panelled technology
- MDF stiles and rails covered with the GREKO, PREMIUM, ST CPL facings or ST CPL laminate with the AntiFinger coating
- glued laminated timber stiles covered with HDF and MDF boards<sup>4)</sup>
- 4 mm thick HDF panels with GREKO, CPL or PREMIUM finish
- brushed aluminium insert profiles
- optional door frame extension panels and a crossheads with pilasters are available for surcharge, pp. 139-141
- the door can be trimmed by a customer; go to p. 137 for details

## HARDWARE

- rebated door leaves: three silver 2-pin hinges adjusted horizontally
- three concealed hinges in a non-rebated leaf, silver (optionally black - subject to an additional charge); hinges supplied with and included in the price of the door frame
- lever tumbler lock in a rebated door leaf and a key-locked magnetic lock (lever tumbler lock as an option) in a non-rebated door leaf, thumb turn cylinder, economy, with a silver blockade; optionally, against an additional charge, a black or gold magnetic lock

## GLAZING

- tempered 4 mm glass, frosted or clear as a standard and, against an additional charge, laminated VSG 221 safety glass frosted or black plain on both sides
- possibility to change the glazing side to REVERSE (standard glazing for OBVERSE)

## AVAILABLE SOLUTIONS (pp. 142-153)

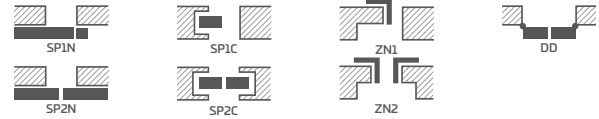

## AVAILABLE DOOR LEAF WIDTHS

60 70 80N<sup>5)</sup> 80 90 100

### GREKO

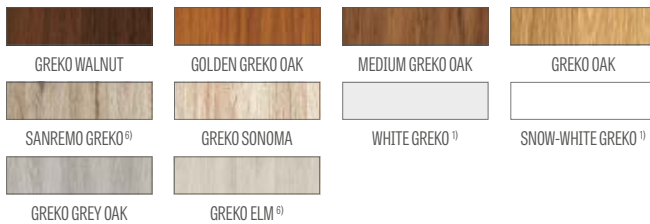

### PREMIUM

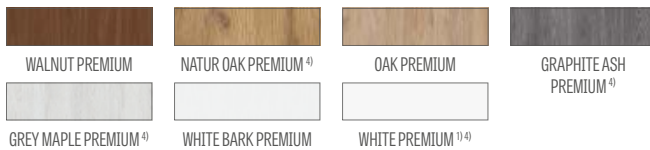

### CPL

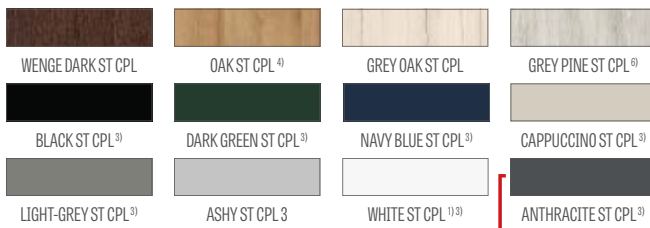

NEW



Glulam timber stiles<sup>4)</sup>

## EXTRA CHARGES

factory pre-drilled through holes for handles (split handles) ordered together with the door leaf

enhanced airflow trim, ventilation undercut standard or mini (p. 137)

plastic woodgrain sleeves (4 pcs)

round and square metal sleeves (4 pcs); brushed nickel or patina finish in white and black

ventilation grille (only for door leaf widths of 80, 90, 100)

"100" rebated and non-rebated door leaf

VSG 221 laminated safety glass, plain on both sides

metal hinge casings in rebated door leaf

(colour: brushed nickel, patina, glossy chrome, glossy brass, white and black)

drop down seal<sup>2)</sup>

can be replaced with a black or golden magnetic lock for non-rebated door leaves

can be changed to hinges and strike plate in black or gold for non-rebated door leaves

magnetic stop (buffer)<sup>2)</sup>

(available in six colours p. 137)

glulam timber stiles<sup>4)</sup>

<sup>1)</sup> plain white facing imitating a painted surface

<sup>2)</sup> a stop will not allow a drop down seal and an enhanced airflow trim to be used, and vice versa

<sup>3)</sup> special AntiFinger coating to reduce dirt and fingerprints

<sup>4)</sup> glulam timber stiles covered with HDF and MDF boards available for WHITE PREMIUM, NATUR OAK PREMIUM, GRAPHITE ASH PREMIUM, GREY MAPLE PREMIUM, OAK ST CPL at extra charge

<sup>5)</sup> only for non-rebated door leaves

<sup>6)</sup> until stock lasts



# KROKUS

REBATED AND NON-REBATED INTERIOR STILE PANELLED DOORS



KROKUS 1, BLACK ST CPL facing layer, handle: CUBE PREMIUM, brushed chrome, matt



KROKUS 1



KROKUS 2



KROKUS 3



KROKUS 4



KROKUS 5



KROKUS 6

KROKUS 4 in BLACK ST CPL facing layer with CUBE PREMIUM handle, brushed chrome, matt



## DESIGN

- rebated or non-rebated door leaf made in the STILE panelled technology
- MDF stiles and rails covered with the GREKO, PREMIUM, ST CPL facings or ST CPL laminate with the AntiFinger coating
- glued laminated timber stiles covered with HDF and MDF boards<sup>4)</sup>
- 4 mm thick HDF panels with GREKO, CPL or PREMIUM finish
- brushed aluminium insert profiles
- optional door frame extension panels and a crossheads with pilasters are available for surcharge, pp. 139-141
- the door can be trimmed by a customer; go to p. 137 for details

## HARDWARE

- rebated door leaves: three silver 2-pin hinges adjusted horizontally
- three concealed hinges in a non-rebated leaf, silver (optionally black - subject to an additional charge); hinges supplied with and included in the price of the door frame
- lever tumbler lock in a rebated door leaf and a key-locked magnetic lock (lever tumbler lock as an option) in a non-rebated door leaf, thumb turn cylinder, economy, with a silver blockade; optionally, against an additional charge, a black or gold magnetic lock

## GLAZING

- tempered 4 mm glass, frosted or clear as a standard and, against an additional charge, laminated VSG 221 safety glass frosted or black plain on both sides
- possibility to change the glazing side to REVERSE (standard glazing for OBVERSE)

## AVAILABLE SOLUTIONS (pp. 142-153)

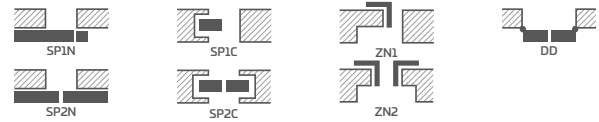

## GREKO

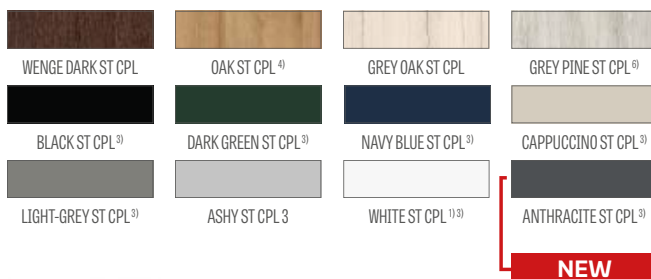
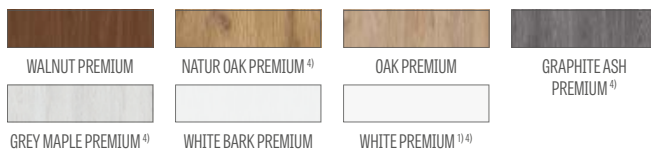
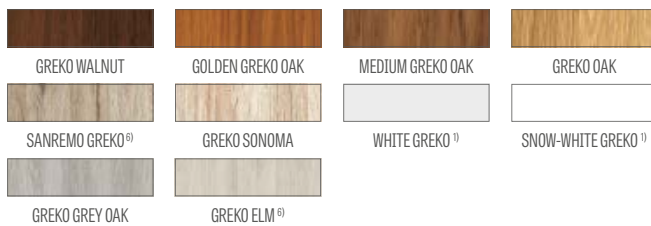

Glulam timber stiles<sup>4)</sup>

## AVAILABLE DOOR LEAF WIDTHS

60 70 80N<sup>5)</sup> 80 90 100

## EXTRA CHARGES

factory pre-drilled through holes for handles (split handles) ordered together with the door leaf

enhanced airflow trim, ventilation undercut standard or mini (p. 137)

plastic woodgrain sleeves (4 pcs)

round and square metal sleeves (4 pcs); brushed nickel or patina finish in white and black

ventilation grille (only for door leaf widths of 80, 90, 100)

"100" rebated and non-rebated door leaf

VSG 221 laminated safety glass, plain on both sides

metal hinge casings in rebated door leaf

(colour: brushed nickel, patina, glossy chrome, glossy brass, white and black)

drop down seal<sup>2)</sup>

can be replaced with a black or golden magnetic lock for non-rebated door leaves

can be changed to hinges and strike plate in black or gold for non-rebated door leaves

magnetic stop (buffer)<sup>2)</sup>

(available in six colours p. 137)

glulam timber stiles<sup>4)</sup>

<sup>1)</sup> plain white facing imitating a painted surface

<sup>2)</sup> a stop will not allow a drop down seal and an enhanced airflow trim to be used, and vice versa

<sup>3)</sup> special **AntiFinger** coating to reduce dirt and fingerprints

<sup>4)</sup> glulam timber stiles covered with HDF and MDF boards available for WHITE PREMIUM, NATUR OAK PREMIUM, GRAPHITE ASH PREMIUM, GREY MAPLE PREMIUM, OAK ST CPL at extra charge

<sup>5)</sup> only for non-rebated door leaves

<sup>6)</sup> until stock lasts

# KAMELIA

REBATED AND NON-REBATED INTERIOR STILE PANELLED DOORS



KAMELIA 1, GRAPHITE ASH PREMIUM facing layer, handle: CUBE, brushed chrome, matt



KAMELIA 1



KAMELIA 2



KAMELIA 3



KAMELIA 4



KAMELIA 5



KAMELIA 6



KAMELIA 7



KAMELIA 8

KAMELIA 1 in GRAPHITE ASH PREMIUM facing layer, with CUBE handle, brushed chrome, matt



## DESIGN

- rebated or non-rebated door leaf made in the STILE panelled technology
- MDF stiles and rails covered with the GREKO, PREMIUM, ST CPL facings or ST CPL laminate with the AntiFinger coating
- glued laminated timber stiles covered with HDF and MDF boards<sup>4)</sup>
- 4 mm thick HDF panels with GREKO, CPL or PREMIUM finish
- optional door frame extension panels and a crossheads with pilasters are available for surcharge, pp. 139-141
- the door can be trimmed by a customer, go to p. 137 for details

## HARDWARE

- rebated door leaves: three silver 2-pin hinges adjusted horizontally
- three concealed hinges in a non-rebated leaf, silver (optionally black - subject to an additional charge); hinges supplied with and included in the price of the door frame
- lever tumbler lock in a rebated door leaf and a key-locked magnetic lock (lever tumbler lock as an option) in a non-rebated door leaf, thumb turn cylinder, economy, with a silver blockade; optionally, against an additional charge, a black or gold magnetic lock

## GLAZING

- tempered 4 mm glass, frosted or clear as a standard and, against an additional charge, laminated VSG 221 safety glass frosted or black plain on both sides
- possibility to change the glazing side to REVERSE (standard glazing for OBERSE)

## AVAILABLE SOLUTIONS (pp. 142-153)

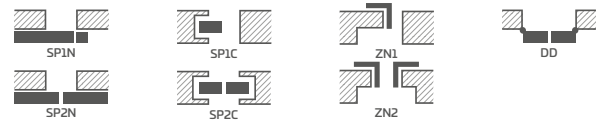

## AVAILABLE DOOR LEAF WIDTHS

60 70 80N<sup>5)</sup> 80 90 100

### GREKO

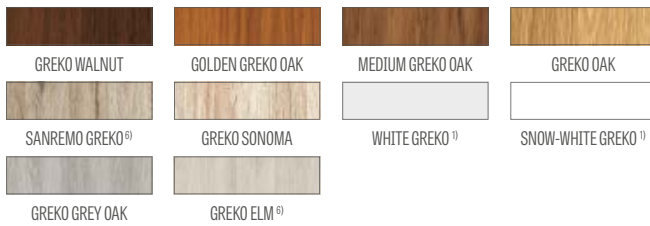

### PREMIUM

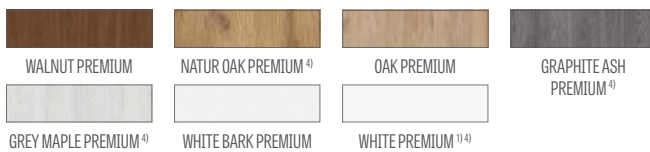

### CPL

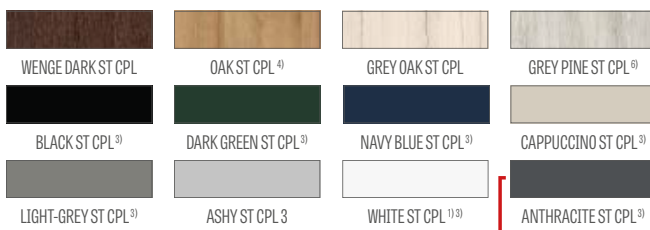

**NEW**



Glulam timber stiles<sup>4)</sup>

## EXTRA CHARGES

factory pre-drilled through holes for handles (split handles) ordered together with the door leaf

enhanced airflow trim, ventilation undercut standard or mini (p. 137)

plastic woodgrain sleeves (4 pcs)

round and square metal sleeves (4 pcs); brushed nickel or patina finish in white and black

ventilation grille (only for door leaf widths of 80, 90, 100)

"100" rebated and non-rebated door leaf

VSG 221 laminated safety glass, plain on both sides

metal hinge casings in rebated door leaf

(colour: brushed nickel, patina, glossy chrome, glossy brass, white and black)

drop down seal<sup>2)</sup>

can be replaced with a black or golden magnetic lock for non-rebated door leaves

can be changed to hinges and strike plate in black or gold for non-rebated door leaves

magnetic stop (buffer)<sup>2)</sup>

(available in six colours p. 137)

glulam timber stiles<sup>4)</sup>

<sup>1)</sup> plain white facing imitating a painted surface

<sup>2)</sup> a stop will not allow a drop down seal and an enhanced airflow trim to be used, and vice versa

<sup>3)</sup> special AntiFinger coating to reduce dirt and fingerprints

<sup>4)</sup> glulam timber stiles covered with HDF and MDF boards available for WHITE PREMIUM, NATUR OAK PREMIUM, GRAPHITE ASH PREMIUM, GREY MAPLE PREMIUM, OAK ST CPL at extra charge

<sup>5)</sup> only for non-rebated door leaves

<sup>6)</sup> until stock lasts

# PETUNIA

REBATED AND NON-REBATED INTERIOR STILE PANELLED DOORS



PETUNIA 1, WHITE ST CPL facing layer, CUBE handle, black matt



PETUNIA 1



PETUNIA 2



PETUNIA 3



PETUNIA 4



PETUNIA 5



PETUNIA 6



PETUNIA 7



PETUNIA 8

PETUNIA 1 in OAK PREMIUM facing layer and TOPAZ stainless steel handle



## DESIGN

- rebated or non-rebated door leaf made in the STILE panelled technology
- MDF stiles and rails covered with the GREKO, PREMIUM, ST CPL facings or ST CPL laminate with the AntiFinger coating
- glued laminated timber stiles covered with HDF and MDF boards<sup>4)</sup>
- 4 mm thick HDF panels with GREKO, CPL or PREMIUM finish
- optional door frame extension panels and a crossheads with pilasters are available for surcharge, pp. 139-141
- the door can be trimmed by a customer, go to p. 137 for details

## HARDWARE

- rebated door leaves: three silver 2-pin hinges adjusted horizontally
- three concealed hinges in a non-rebated leaf, silver (optionally black - subject to an additional charge); hinges supplied with and included in the price of the door frame
- lever tumbler lock in a rebated door leaf and a key-locked magnetic lock (lever tumbler lock as an option) in a non-rebated door leaf, thumb turn cylinder, economy, with a silver blockade; optionally, against an additional charge, a black or gold magnetic lock

## GLAZING

- tempered 4 mm glass, frosted or clear as a standard and, against an additional charge, laminated VSG 221 safety glass frosted or black plain on both sides
- possibility to change the glazing side to REVERSE (standard glazing for OBERSE)

## AVAILABLE SOLUTIONS (pp. 142-153)

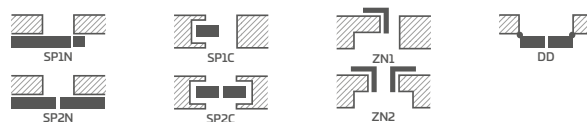

## AVAILABLE DOOR LEAF WIDTHS

60 70 80N<sup>5)</sup> 80 90 100

### GREKO

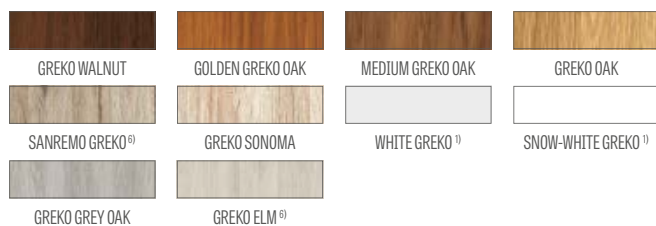

### PREMIUM

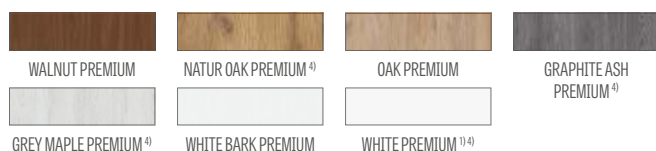

### CPL

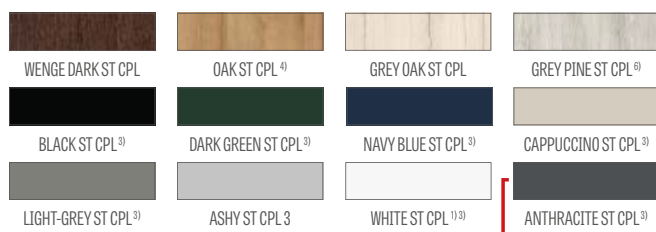

**NEW**



Glulam timber stiles<sup>4)</sup>

## EXTRA CHARGES

factory pre-drilled through holes for handles (split handles) ordered together with the door leaf

enhanced airflow trim, ventilation undercut standard or mini (p. 137)

plastic woodgrain sleeves (4 pcs)

round and square metal sleeves (4 pcs); brushed nickel or patina finish in white and black

ventilation grille (only for door leaf widths of 80, 90, 100)

"100" rebated and non-rebated door leaf

VSG 221 laminated safety glass, plain on both sides

metal hinge casings in rebated door leaf

(colour: brushed nickel, patina, glossy chrome, glossy brass, white and black)

drop down seal<sup>2)</sup>

can be replaced with a black or golden magnetic lock for non-rebated door leaves

can be changed to hinges and strike plate in black or gold for non-rebated door leaves

magnetic stop (buffer)<sup>2)</sup>

(available in six colours p. 137)

glulam timber stiles<sup>4)</sup>

<sup>1)</sup> plain white facing imitating a painted surface

<sup>2)</sup> a stop will not allow a drop down seal and an enhanced airflow trim to be used, and vice versa

<sup>3)</sup> special AntiFinger coating to reduce dirt and fingerprints

<sup>4)</sup> glulam timber stiles covered with HDF and MDF boards available for WHITE PREMIUM, NATUR OAK PREMIUM, GRAPHITE ASH PREMIUM, GREY MAPLE PREMIUM, OAK ST CPL at extra charge

<sup>5)</sup> only for non-rebated door leaves

<sup>6)</sup> until stock lasts



# AZALIA

REBATED AND NON-REBATED INTERIOR STILE PANELLED DOORS



AZALIA 1, GREY OAK GREKO facing layer, handle: CUBE, black matt



AZALIA 1



AZALIA 2



AZALIA 3



AZALIA 4



AZALIA 5



AZALIA 6



AZALIA 7



AZALIA 8

AZALIA 6 in GREY OAK GREKO facing layer with CUBE handle, black matt



## DESIGN

- rebated or non-rebated door leaf made in the STILE panelled technology
- MDF stiles and rails covered with the GREKO, PREMIUM, ST CPL facings or ST CPL laminate with the AntiFinger coating
- glued laminated timber stiles covered with HDF and MDF boards<sup>4)</sup>
- 4 mm thick HDF panels with GREKO, CPL or PREMIUM finish
- optional door frame extension panels and a crossheads with pilasters are available for surcharge, pp. 139-141
- the door can be trimmed by a customer, go to p. 137 for details

## HARDWARE

- rebated door leaves: three silver 2-pin hinges adjusted horizontally
- three concealed hinges in a non-rebated leaf, silver (optionally black - subject to an additional charge); hinges supplied with and included in the price of the door frame
- lever tumbler lock in a rebated door leaf and a key-locked magnetic lock (lever tumbler lock as an option) in a non-rebated door leaf, thumb turn cylinder, economy, with a silver blockade; optionally, against an additional charge, a black or gold magnetic lock

## GLAZING

- tempered 4 mm glass, frosted or clear as a standard and, against an additional charge, laminated VSG 221 safety glass frosted or black plain on both sides
- possibility to change the glazing side to REVERSE (standard glazing for OBERVERSE)

## AVAILABLE SOLUTIONS (pp. 142-153)

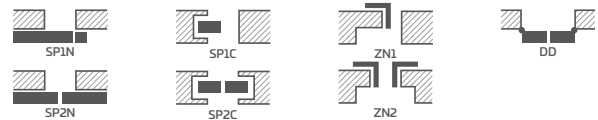

## AVAILABLE DOOR LEAF WIDTHS

60 70 80N<sup>5)</sup> 80 90 100

### GREKO

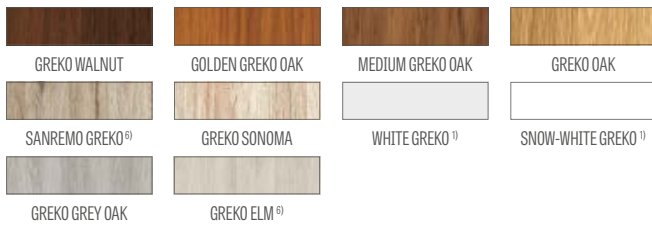

### PREMIUM

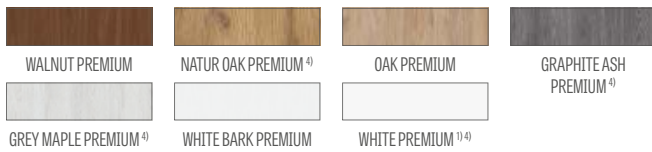

### CPL

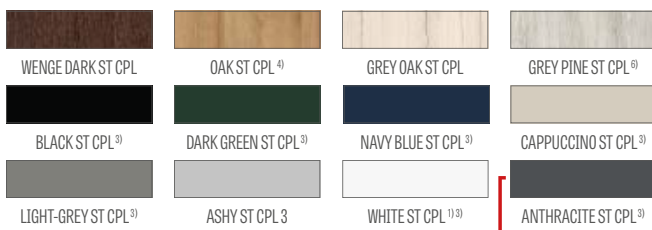

**NEW**



Glulam timber stiles<sup>4)</sup>

## EXTRA CHARGES

factory pre-drilled through holes for handles (split handles) ordered together with the door leaf

enhanced airflow trim, ventilation undercut standard or mini (p. 137)

plastic woodgrain sleeves (4 pcs)

round and square metal sleeves (4 pcs); brushed nickel or patina finish in white and black

ventilation grille (only for door leaf widths of 80, 90, 100)

"100" rebated and non-rebated door leaf

VSG 221 laminated safety glass, plain on both sides

metal hinge casings in rebated door leaf

(colour: brushed nickel, patina, glossy chrome, glossy brass, white and black)

drop down seal<sup>2)</sup>

can be replaced with a black or golden magnetic lock for non-rebated door leaves

can be changed to hinges and strike plate in black or gold for non-rebated door leaves

magnetic stop (buffer)<sup>2)</sup>

(available in six colours p. 137)

glulam timber stiles<sup>4)</sup>

<sup>1)</sup> plain white facing imitating a painted surface

<sup>2)</sup> a stop will not allow a drop down seal and an enhanced airflow trim to be used, and vice versa

<sup>3)</sup> special **AntiFinger** coating to reduce dirt and fingerprints

<sup>4)</sup> glulam timber stiles covered with HDF and MDF boards available for WHITE PREMIUM, NATUR OAK PREMIUM, GRAPHITE ASH PREMIUM, GREY MAPLE PREMIUM, OAK ST CPL at extra charge

<sup>5)</sup> only for non-rebated door leaves

<sup>6)</sup> until stock lasts



# HIACYNT

REBATED AND NON-REBATED INTERIOR STILE PANELLED DOORS



MISKANT 6, NAVY BLUE ST CPL facing layer; QUANTA FIT handle, black matt



HIACYNT 1



HIACYNT 2



HIACYNT 3



HIACYNT 4



HIACYNT 5



HIACYNT 6



HIACYNT 7



HIACYNT 8

HIACYNT 1 in NAVY BLUE ST CPL facing layer with QUANTAFIT handle, black matt



## DESIGN

- rebated or non-rebated door leaf made in the STILE panelled technology
- MDF stiles and rails covered with the GREKO, PREMIUM, ST CPL facings or ST CPL laminate with the AntiFinger coating
- glued laminated timber stiles covered with HDF and MDF boards<sup>4)</sup>
- 22mm thick HDF panels with GREKO, CPL or PREMIUM finish
- optional door frame extension panels and a crossheads with pilasters are available for surcharge, pp. 139-141
- the door can be trimmed by a customer, go to p. 137 for details

## HARDWARE

- rebated door leaves: three silver 2-pin hinges adjusted horizontally
- three concealed hinges in a non-rebated leaf, silver (optionally black - subject to an additional charge); hinges supplied with and included in the price of the door frame
- lever tumbler lock in a rebated door leaf and a key-locked magnetic lock (lever tumbler lock as an option) in a non-rebated door leaf, thumb turn cylinder, economy, with a silver blockade; optionally, against an additional charge, a black or gold magnetic lock

## GLAZING

- tempered 4 mm glass, frosted or clear as a standard and, against an additional charge, laminated VSG 221 safety glass frosted or black plain on both sides
- possibility to change the glazing side to REVERSE (standard glazing for OBERVERSE)

## AVAILABLE SOLUTIONS (pp. 142-153)

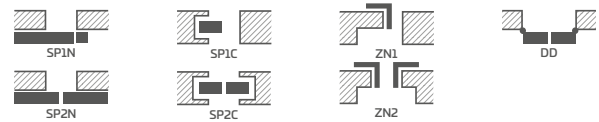

## AVAILABLE DOOR LEAF WIDTHS

60 70 80N<sup>5)</sup> 80 90 100

## EXTRA CHARGES

factory pre-drilled through holes for handles (split handles) ordered together with the door leaf

enhanced airflow trim, ventilation undercut standard or mini (p. 137)

plastic woodgrain sleeves (4 pcs)

round and square metal sleeves (4 pcs); brushed nickel or patina finish in white and black

ventilation grille (only for door leaf widths of 80, 90, 100)

"100" rebated and non-rebated door leaf

VSG 221 laminated safety glass, plain on both sides

metal hinge casings in the rebated door leaf (brushed nickel, patina, polished chrome, polished brass, white and black)

drop down seal<sup>2)</sup>

can be replaced with a black or golden magnetic lock for non-rebated door leaves

can be changed to hinges and strike plate in black or gold for non-rebated door leaves

magnetic stop (buffer)<sup>2)</sup>  
(available in six colours p. 137)

glulam timber stiles<sup>4)</sup>

## GREKO

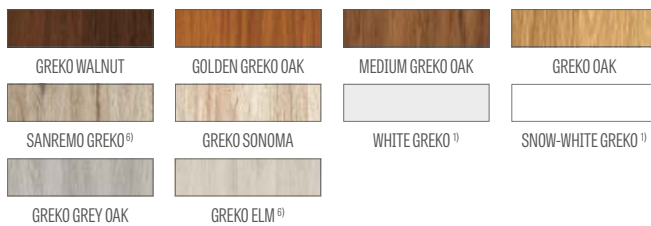

## PREMIUM

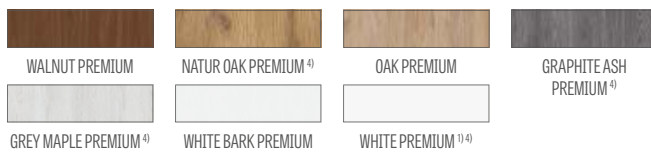

## CPL

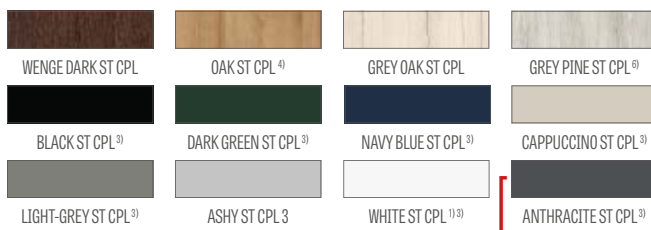

NEW



Glulam timber stiles<sup>4)</sup>

<sup>1)</sup> plain white facing imitating a painted surface

<sup>2)</sup> a stop will not allow a drop down seal and an enhanced airflow trim to be used, and vice versa

<sup>3)</sup> special AntiFinger coating to reduce dirt and fingerprints

<sup>4)</sup> glulam timber stiles covered with HDF and MDF boards available for WHITE PREMIUM, NATUR OAK PREMIUM, GRAPHITE ASH PREMIUM, GREY MAPLE PREMIUM, OAK ST CPL at extra charge

<sup>5)</sup> only for non-rebated door leaves

<sup>6)</sup> until stock lasts

# FRAGI

REBATED INTERIOR STILE PANELLED DOORS



FRAGI 5, BLACK ST CPL facing layer, handle: CUBE PREMIUM, brushed chrome, matt



FRAGI 1



FRAGI 4  
DECORMAT



FRAGI 5  
CLEAR



FRAGI 7  
DECORMAT GRAFIT



FRAGI 9



FRAGI 10



FRAGI 15  
Frosted VSG/ESG



FRAGI 16  
Black VSG/ESG

FRAGI 4 in BLACK ST CPL facing layer with CUBE PREMIUM handle, brushed chrome, matt

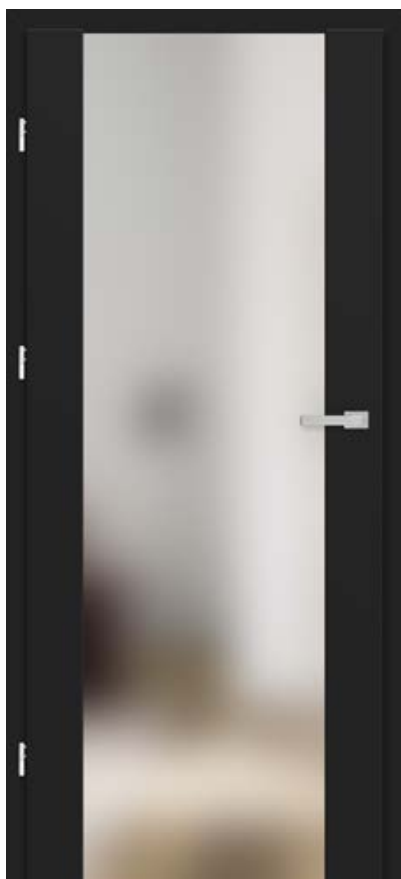

## DESIGN

- rebated door leaf made in STILE panelled technology
- MDF stiles and rails covered with the GREKO, PREMIUM, ST CPL facings or ST CPL laminate with the AntiFinger coating
- glued laminated timber stiles covered with HDF and MDF boards<sup>3)</sup>
- optional door frame extension panels and a crossheads with pilasters are available for surcharge, pp. 139-141

## HARDWARE

- rebated door leaves: three silver 2-pin hinges adjusted horizontally
- A lever tumbler lock, euro profile cylinder, economy lock or with a thumb turn

## GLAZING

- 8 mm tempered or tempered and VSG/ESG 441 laminated safety glass, frosted or black, plain on both sides (in Fragi 15 & Fragi 16)
- possibility to change the glazing side to REVERSE (standard glazing for OBVERSE)

## AVAILABLE SOLUTIONS (pp. 151-153)



## AVAILABLE DOOR LEAF WIDTHS



## EXTRA CHARGES

factory pre-drilled through holes for handles (split handles) ordered together with the door leaf

Ventilation undercut

metal hinge casings in rebated door leaf  
(colour: brushed nickel, patina, glossy chrome, glossy brass, white and black)

magnetic stop (buffer)  
(available in six colours p. 137)

glulam timber stiles<sup>3)</sup>

Note:

The picture shows only an 80cm-wide door leaf. The proportion in the picture differ slightly for the other FRAGI 1 model widths. For further details and photos go to our website: [www.erkado.pl](http://www.erkado.pl)

## GREKO

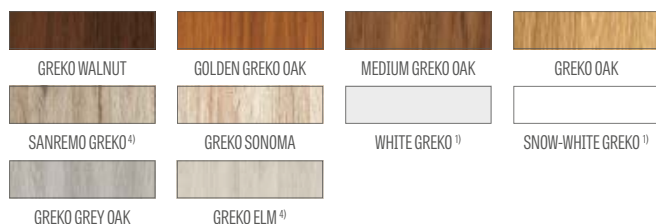

## PREMIUM

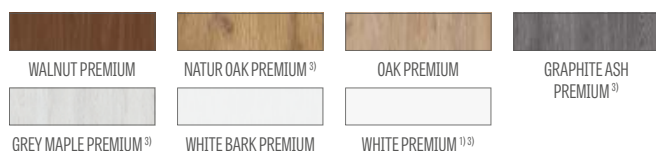

## CPL

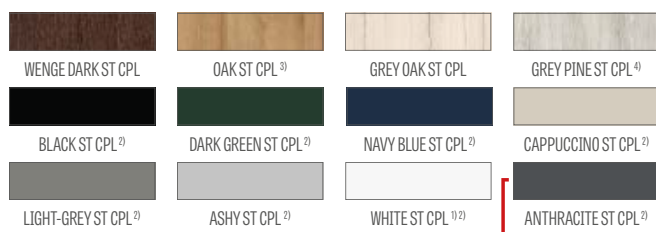

**NEW**

## STANDARD "OBVERSE" GLAZING

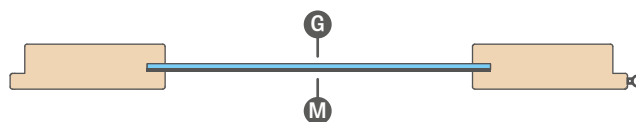

## "REVERSE" GLAZING MADE TO ORDER

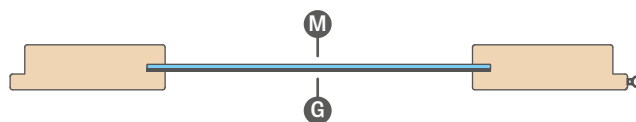

**G** Plain side; **M** ornamented matt side;



Glulam timber stiles<sup>3)</sup>

<sup>1)</sup> plain white facing imitating a painted surface

<sup>2)</sup> special **AntiFinger** coating to reduce dirt and fingerprints

<sup>3)</sup> glulam timber stiles covered with HDF and MDF boards available for WHITE PREMIUM, NATUR OAK PREMIUM, GRAPHITE ASH PREMIUM, GREY MAPLE PREMIUM, OAK ST CPL at extra charge

<sup>4)</sup> until stock lasts



# GRAF GLASS DOORS

INTERIOR GLASS DOORS

NEW



GRAF 8 DECORMAT

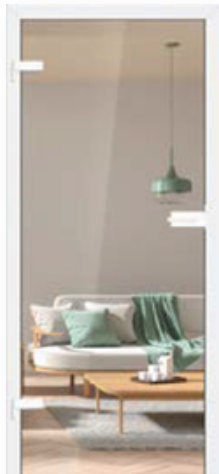

GRAF 9 TRANSPARENT



GRAF 11 DECORMAT GRAPHITE

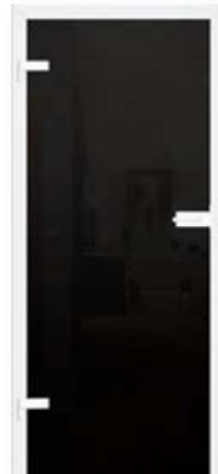

GRAF 65 VSG/ESG, black opaque



GRAF 32

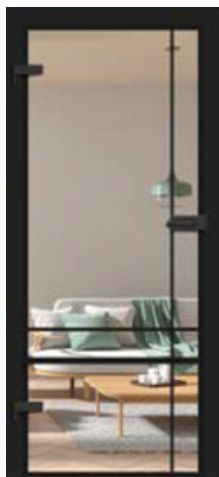

GRAF 33

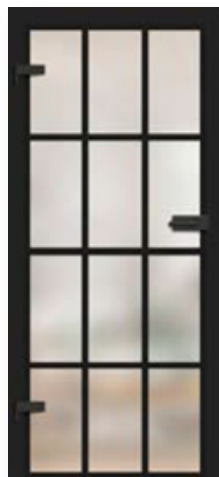

GRAF 35



GRAF 36

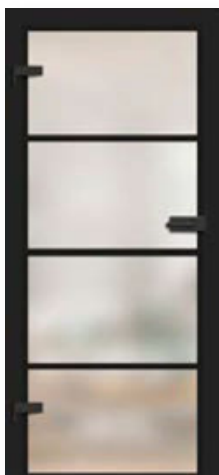

GRAF 38

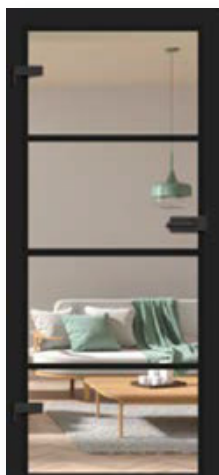

GRAF 39

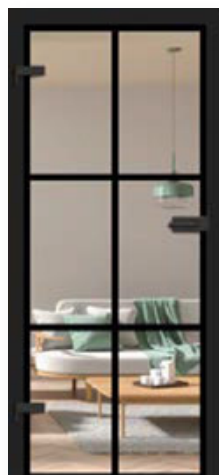

GRAF 61



GRAF 62

GLAZING TRANSLUCENCY REFERENCE PHOTOS in p. 138

GRAF-36.8 mm tempered glass with black decorative pattern, door frame in BLACK ST CPL facing



## DESIGN

- 8 mm tempered glass with or without external decorative patterns, 8 mm tinted glass (GRAF 26), laminated and tempered VSG/ESG (GRAF 65, 66) glass or, for an extra charge, laminated and tempered VSG/ESG glass with black internal decorative patterns for GRAF 32, 33, 35, 36, 38, 39, 61, 62
- possibility to change the glazing side to REVERSE (standard glazing for OBVERSE)
- frosted or plain glass with black or white painted patterns, depending on the model design
- the line width (thickness) of the GRAF 35, 36, 38, 39, 61, 62 models is 30 mm
- optional door frame extension panels and a crossheads with pilasters are available for surcharge, pp. 139-141
- Available model GRAF 66, VSG/ESG frosted glass **NEW**

## FIXED AND ADJUSTABLE FRAMES

- for prices of fixed and adjustable frames for rebated doors go to pp. 168-171
- no electric strike possible
- 10 mm pin hinge for glass panes frames
- in the fixed and adjustable frame, it is possible to change the black or white powder-coated striker plate (at an extra charge)
- **ONLY REBATED FRAMES IN ALL AVAILABLE DECORS, STEEL FRAMES AND THE WHITE PAINTED TITANIUM UV FRAME ARE AVAILABLE FOR GLASS GRAF DOORS**

**NOTE:** For the extended Glass Door Collection and a variety of available models go to our website: [www.erkado.pl](http://www.erkado.pl). You can also order the available models through the B2B panel.

## AVAILABLE DOOR LEAF WIDTHS

60 70 80 90, 100, 110 (for an extra charge)



See more at [www.erkado.pl](http://www.erkado.pl)

## EXTRA CHARGES

VSG/ESG glass with internal black decorative pattern<sup>3)</sup>  
(GRAF 32, 33, 35, 36, 38, 39, 61, 62)

rail-mounted door closer in silver, black

"90" door leaf

"100" and "110" door leaf<sup>2)</sup> **NEW**

(three hinges used as standard)

ventilation undercut

black or white striker plate

## METAL-BUD FITTINGS stainless steel, black, white (available shapes: oval or rectangle)

**Metal-Bud**



2A OVAL



3A OVAL



1A OVAL



4AZ OVAL EXTERNAL <sup>1)</sup>  
4AW OVAL INTERNAL



Oval HINGE



2B RECTANGLE



3B RECTANGLE



1B RECTANGLE



4BZ RECTANGLE EXTERNAL <sup>1)</sup>  
4BW RECTANGLE INTERNAL



Rectangle HINGE



2B RECTANGLE



3B RECTANGLE



1B RECTANGLE



4BZ RECTANGLE EXTERNAL <sup>1)</sup>  
4BW RECTANGLE INTERNAL



Rectangle HINGE

<sup>1)</sup> detailed description on selecting bathroom fittings (locking device) p. 136;

<sup>2)</sup> available for GRAF 8, 9, 11, 65, 66 models;

<sup>3)</sup> with VSG/ESG glass there are two glued glass panes visible from the edge

# LAMELLAS

WALL-MOUNTED



Wall lamellas: decorative strip OAK ST CPL, adapter BLACK ST CPL, skirting board OAK ST CPL, door BALDUR 1 OAK ST CPL, black VSG glass

Decorative lamellas are mounted on the wall as a decorative element and at the same time improve the acoustics in the room.

Mounting is possible in several ways - the decorative skirting board can be mounted to the wall by means of a mounting strip only or with the use of adapters which constitute a base for the panels.

Decorative lamellas are available with PREMIUM and ST CPL facings and can be joined in selected combinations.



composition of decorative lamellas with the skirting board OAK ST CPL



components of wall lamellas

## DECORATIVE STRIP

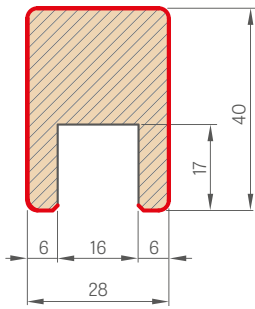

## MOUNTING STRIP

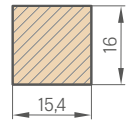

## END STRIP

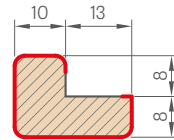

## ADAPTER

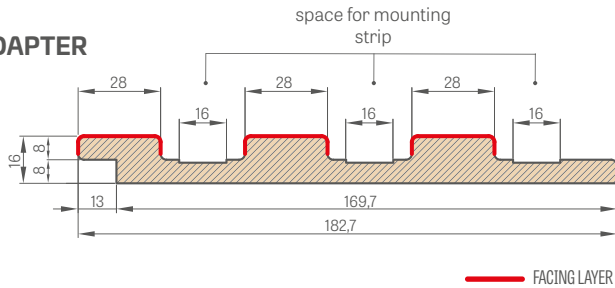

ST CPL & PREMIUM
adapter, length 2750 mm
decorative strip (mounting strip included), length 2750 mm
end strip, length 2750 mm
self-adhesive blanking straps for concealing the cut of a decorative strip

The individual components of the decorative lamella system are commercially available in a length of 2750 mm, however each product has a production length of 2800 mm and is delivered in this length, where 25 mm per side is a margin for free trimming before installation and also a reserve in case of transport damage.

The wall lamellas can also be mounted without an adapter directly to the wall using only a mounting strip on which we mount the decorative strip.

Decorative strip (with the mounting strip included) can be purchased only in multiple of 3 pieces, e.g. 3 pcs, 6 pcs, 9 pcs, etc.

The blanking straps are available across the range of facings and are used to conceal the cut of the decorative strip. The blanking straps have a self-adhesive surface on one side.

adapter - quantity in pack 1 piece

end strip - package quantity 1 piece

decorative strip + mounting strip - pack of 3 pcs + 3 pcs

## DECORATIVE LAMELLA

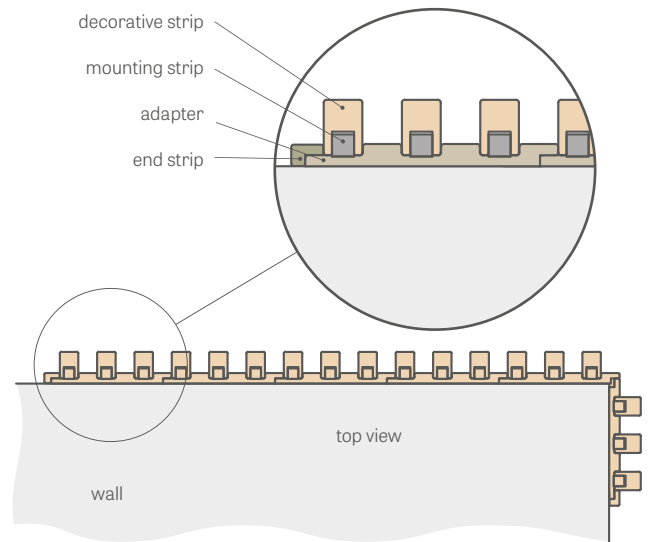

Installation video  
variant with an adapter:  
<https://youtu.be/p3I7u3cWMmg>



Installation video  
no adapter variant:  
<https://youtu.be/fFa5afWWFOM>



## PREMIUM

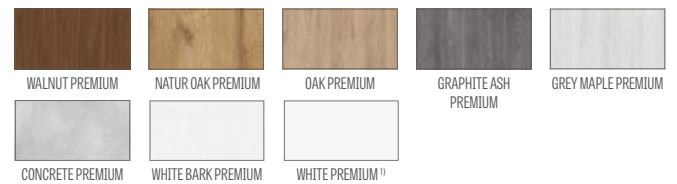

## CPL

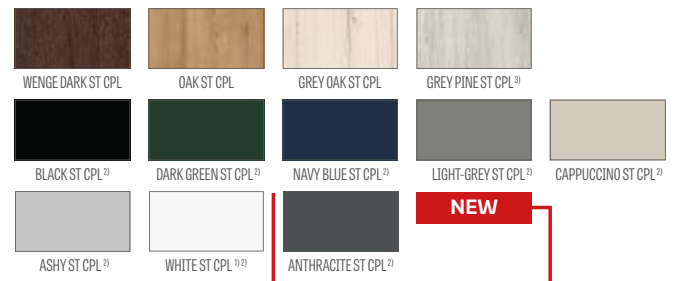

# SKIRTING BOARDS

## SKIRTING BOARD

- length: 2.40 running metres.
- the skirting board is made of moisture resistant MDF board. Available variants: WHITE TITANIUM UV paint; facings: GREKO, ST CPL, PREMIUM and in a base facing to be paint coated.
- fitting method: bonding to wall

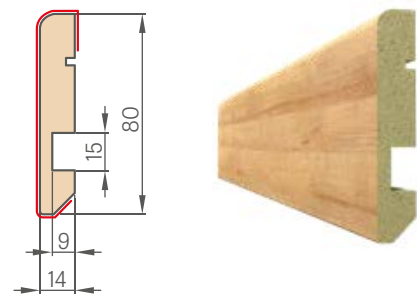

<sup>1)</sup> plain white facing imitating a painted surface

<sup>2)</sup> special **AntiFinger** coating to reduce dirt and fingerprints

<sup>3)</sup> until stock lasts



# AMARYLIS

REBATED, NON-REBATED AND REVERSE PAINTED DOORS



AMARYLIS 1 with CUBE PREMIUM handle, black matt



AMARYLIS 1



AMARYLIS 2



AMARYLIS 3



AMARYLIS 4



AMARYLIS 5



AMARYLIS 6



AMARYLIS 7



AMARYLIS 8



AMARYLIS 9



**NEW**

Double-sided stick-on muntin  
25 mm



AMARYLIS 6 with CUBE PREMIUM handle, black matt

**DESIGN**

- rebated, non-rebated or reverse door leaf in STILE technology for an additional charge
- MDF stiles and rails coated with a facing layer and painted with UV-resistant varnish
- optional, at an extra charge, glulam timber stiles covered with HDF and MDF boards
- double-sided muntin applied to glass, 25 mm wide and of respective heights: vertical 12 mm and horizontal 8 mm
- optional door frame extension panels and a crossheads with pilasters are available for surcharge, pp. 139-141
- the door can be trimmed by a customer, go to p. 137 for details

**FINISH**

- door leaves and door frames coated with water-based UV hardened varnish for high resistance to adverse use conditions

**HARDWARE**

- rebated door leaves: three silver 2-pin hinges adjusted horizontally
- three concealed hinges in a non-rebated leaf, silver (optionally black - subject to an additional charge); hinges supplied with and included in the price of the door frame
- lever tumbler lock in a rebated door leaf and a key-locked magnetic lock (lever tumbler lock as an option) in a non-rebated door leaf, thumb turn cylinder, economy, with a silver blockade; optionally, against an additional charge, a black or gold magnetic lock

**GLAZING**

- tempered 4 mm glass, frosted or clear as a standard and, against an additional charge, laminated VSG 221 safety glass frosted or black plain on both sides
- possibility to change the glazing side to REVERSE (standard glazing for OBERSE)

**EXTRA CHARGES**

factory pre-drilled through holes for handles (split handles) ordered together with the door leaf

reverse door leaf

enhanced airflow trim, ventilation undercut standard or mini (p. 137)

"100" rebated and non-rebated door leaf

metal hinge casings in the rebated door leaf (brushed nickel, patina, polished chrome, polished brass, white and black)

VSG 221 laminated safety glass, plain on both sides

drop down seal <sup>1)</sup>

can be replaced with a black or golden magnetic lock for non-rebated door leaves

can be changed to hinges and strike plate in black or gold for non-rebated door leaves

magnetic stop (buffer) <sup>1)</sup>  
(available in six colours p. 137)

PL2112 standard

+15% on the door price before surcharges

glulam timber stiles

**PAINTED**



TITANIUM WHITE UV

**AVAILABLE SOLUTIONS** (pp. 142-153)

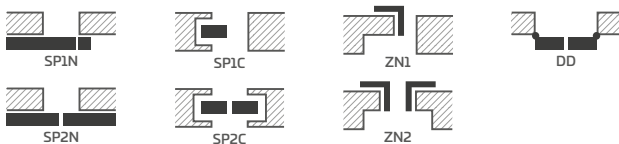

**AVAILABLE DOOR LEAF WIDTHS**

- 60 70 80N <sup>2)</sup> 80 90 100

<sup>1)</sup> a stop will not allow a drop down seal and an enhanced airflow trim to be used, and vice versa

<sup>2)</sup> only for non-rebated door leaves

# PEONIA

REBATED, NON-REBATED AND REVERSE PAINTED DOORS



PEONIA 1 with BELLA SLIM handle, shiny brass, pilasters and decorative crossheads<sup>3)</sup>



PEONIA 1



PEONIA 2



PEONIA 3



NEW

Double-sided stick-on muntin  
25 mm



PEONIA 4



PEONIA 5



PEONIA 6

PEONIA 2 with CUBE handle, black matt, pilasters and decorative crossheads<sup>3)</sup>



**DESIGN**

- rebated, non-rebated or reverse door leaf in STILE technology for an additional charge
- MDF stiles and rails coated with a facing layer and painted with UV-resistant varnish
- optional, at an extra charge, glulam timber stiles covered with HDF and MDF boards
- 16 mm thick HDF panels, moulded and coated with UV resistant varnish
- double-sided muntin applied to glass, 25 mm wide and of respective heights: vertical 12 mm and horizontal 8 mm
- optional door frame extension panels and a crossheads with pilasters are available for surcharge, pp. 139-141
- the door can be trimmed by a customer; go to p. 137 for details

**FINISH**

- door leaves and door frames coated with water-based UV hardened varnish for high resistance to adverse use conditions

**HARDWARE**

- rebated door leaves: three silver 2-pin hinges adjusted horizontally
- three concealed hinges in a non-rebated leaf, silver (optionally black - subject to an additional charge); hinges supplied with and included in the price of the door frame
- lever tumbler lock in a rebated door leaf and a key-locked magnetic lock (lever tumbler lock as an option) in a non-rebated door leaf, thumb turn cylinder, economy, with a silver blockade; optionally, against an additional charge, a black or gold magnetic lock

**GLAZING**

- frosted or transparent tempered glass as standard, and custom-made frosted or black VSG 221 laminated safety glass, plain on both sides
- possibility to change the glazing side to REVERSE (standard glazing for OBVERSE)

**EXTRA CHARGES**

factory pre-drilled through holes for handles (split handles) ordered together with the door leaf

reverse door leaf

enhanced airflow trim, ventilation undercut standard or mini (p. 137)

"100" rebated and non-rebated door leaf

metal hinge casings in the rebated door leaf (brushed nickel, patina, polished chrome, polished brass, white and black)

VSG 221 laminated safety glass, plain on both sides

drop down seal <sup>1)</sup>

can be replaced with a black or golden magnetic lock for non-rebated door leaves

can be changed to hinges and strike plate in black or gold for non-rebated door leaves

magnetic stop (buffer) <sup>1)</sup>  
(available in six colours p. 137)

PL2112 standard

+15% on the door price before surcharges

glulam timber stiles

**PAINTED**



TITANIUM WHITE UV

**AVAILABLE SOLUTIONS** (pp. 142-153)

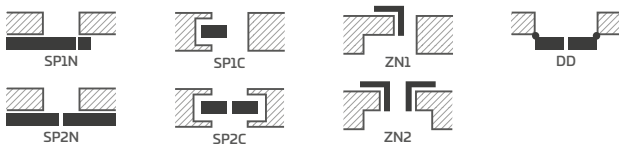

**AVAILABLE DOOR LEAF WIDTHS**



<sup>1)</sup> a stop will not allow a drop down seal and an enhanced airflow trim to be used, and vice versa

<sup>2)</sup> only for non-rebated door leaves

<sup>3)</sup> decorative crossheads with pilasters for surcharge, p. 139

# MISKANT

REBATED, NON-REBATED AND REVERSE PAINTED DOORS



MISKANT 2, BELLA SLIM handle, black matt



MISKANT 1



MISKANT 2

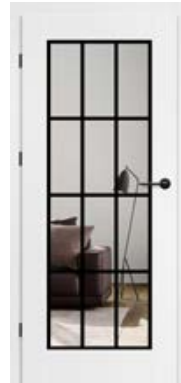

MISKANT 3



NEW

Black lines 18 mm wide  
silk-screen painted



MISKANT 4



MISKANT 5



MISKANT 6



MISKANT 4 with BELLA SLIM handle, black matt

## DESIGN

- rebated, non-rebated or reverse door leaf in STILE technology for an additional charge
- MDF stiles and rails coated with a facing layer and painted with UV-resistant varnish
- optional, at an extra charge, glulam timber stiles covered with HDF and MDF boards
- optional door frame extension panels and a crossheads with pilasters are available for surcharge, pp. 139-141
- the door can be trimmed by a customer; go to p. 137 for details

## FINISH

- door leaves and door frames coated with water-based UV hardened varnish for high resistance to adverse use conditions

## HARDWARE

- rebated door leaves: three silver 2-pin hinges adjusted horizontally
- three concealed hinges in a non-rebated leaf, silver (optionally black - subject to an additional charge); hinges supplied with and included in the price of the door frame
- lever tumbler lock in a rebated door leaf and a key-locked magnetic lock (lever tumbler lock as an option) in a non-rebated door leaf, thumb turn cylinder, economy, with a silver blockade; optionally, against an additional charge, a black or gold magnetic lock

## GLAZING

- tempered frosted glass (MISKANT 2, 4, 6) or clear glass (MISKANT 1, 3, 5), 4 mm thick or, for surcharge, VSG laminated glass with internal decorative pattern
- possibility to change the glazing side to REVERSE (standard glazing for OBVERSE)
- black screen printed lines on one side of glass with a width (thickness) of 18 mm

### STANDARD "OBVERSE" GLAZING

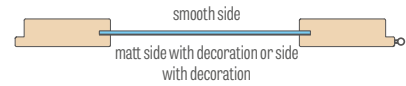

### "REVERSE" GLAZING MADE TO ORDER



## PAINTED



TITANIUM WHITE UV

## AVAILABLE SOLUTIONS (pp. 142-153)

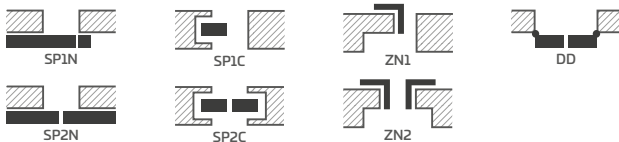

## AVAILABLE DOOR LEAF WIDTHS

60 70 80N<sup>2)</sup> 80 90 100

## EXTRA CHARGES

factory pre-drilled through holes for handles (split handles) ordered together with the door leaf

reverse door leaf

VSG laminated glass with internal decorative pattern in black or white

enhanced airflow trim, ventilation undercut standard or mini (p. 137)

"100" rebated and non-rebated door leaf

metal hinge casings in the rebated door leaf (brushed nickel, patina, polished chrome, polished brass, white and black)

drop down seal<sup>1)</sup>

can be replaced with a black or golden magnetic lock for non-rebated door leaves

can be changed to hinges and strike plate in black or gold for non-rebated door leaves

magnetic stop (buffer)<sup>1)</sup>  
(available in six colours p. 137)

glulam timber stiles

<sup>1)</sup> a stop will not allow a drop down seal and an enhanced airflow trim to be used, and vice versa

<sup>2)</sup> only for non-rebated door leaves

# NEMEZJA

REBATED, NON-REBATED AND REVERSE PAINTED DOORS



NEMEZJA 8, BELLA SLIM handle, round, glossy brass



NEMEZJA 1



NEMEZJA 4



NEMEZJA 7



NEMEZJA 8



NEMEZJA 9



NEMEZJA 10



NEMEZJA 11



NEMEZJA 12



NEMEZJA 13



NEMEZJA 14

NEMEZJA 6 with BELLA SLIM handle, round, glossy brass



## DESIGN

- rebated, non-rebated or reverse door leaf in STILE technology for an additional charge
- MDF stiles and rails coated with a facing layer and painted with UV-resistant varnish
- optional, at an extra charge, glulam timber stiles covered with HDF and MDF boards
- 16 mm thick HDF panels, moulded and coated with UV resistant varnish
- optional door frame extension panels and a crossheads with pilasters are available for surcharge, pp. 139-141
- the door can be trimmed by a customer, go to p. 137 for details

## FINISH

- door leaves and door frames coated with water-based UV hardened varnish for high resistance to adverse use conditions

## HARDWARE

- rebated door leaves: three silver 2-pin hinges adjusted horizontally
- three concealed hinges in a non-rebated leaf, silver (optionally black - subject to an additional charge); hinges supplied with and included in the price of the door frame
- lever tumbler lock in a rebated door leaf and a key-locked magnetic lock (lever tumbler lock as an option) in a non-rebated door leaf, thumb turn cylinder, economy, with a silver blockade; optionally, against an additional charge, a black or gold magnetic lock

## GLAZING

- frosted or transparent tempered glass as standard, and custom-made frosted or black VSG 221 laminated safety glass, plain on both sides
- possibility to change the glazing side to REVERSE (standard glazing for OBVERSE)

## EXTRA CHARGES

factory pre-drilled through holes for handles (split handles) ordered together with the door leaf

reverse door leaf

enhanced airflow trim, ventilation undercut standard or mini (p. 137)

"100" rebated and non-rebated door leaf

metal hinge casings in the rebated door leaf (brushed nickel, patina, polished chrome, polished brass, white and black)

VSG 221 laminated safety glass, plain on both sides

drop down seal <sup>1)</sup>

can be replaced with a black or golden magnetic lock for non-rebated door leaves

can be changed to hinges and strike plate in black or gold for non-rebated door leaves

magnetic stop (buffer) <sup>1)</sup>  
(available in six colours p. 137)

PL2112 standard

+15% on the door price before surcharges

glulam timber stiles

## PAINTED



TITANIUM WHITE UV

## AVAILABLE SOLUTIONS (pp. 142-153)

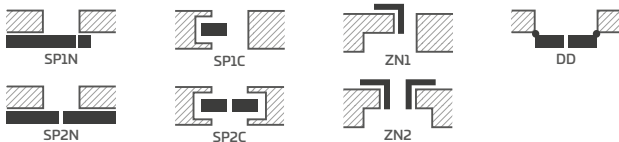

## AVAILABLE DOOR LEAF WIDTHS

60 70 80N<sup>2)</sup> 80 90 100

<sup>1)</sup> a stop will not allow a drop down seal and an enhanced airflow trim to be used, and vice versa

<sup>2)</sup> only for non-rebated door leaves



# LAURENCJA

REBATED, NON-REBATED PAINTED DOORS



LAURENCJA 1, black VSG glass, handle: BELLA SLIM, round, black matt



LAURENCJA 1



LAURENCJA 2



LAURENCJA 3



LAURENCJA 4



LAURENCJA 5



LAURENCJA 6

LAURENCIA 1 with BELLAJIM handle, round black matt, and VSG 221 laminated glass, black



## DESIGN

- rebated, non-rebated door leaf made in STILE technology
- MDF stiles and rails coated with a facing layer and painted with UV-resistant varnish
- optional, at an extra charge, glulam timber stiles covered with HDF and MDF boards
- 4 mm thick HDF panels, moulded and coated with UV-resistant varnish
- optional door frame extension panels and a crossheads with pilasters are available for surcharge, pp. 139-141
- the door can be trimmed by a customer, go to p. 137 for details

## FINISH

- door leaves and door frames coated with water-based UV hardened varnish for high resistance to adverse use conditions

## HARDWARE

- rebated door leaves: three silver 2-pin hinges adjusted horizontally
- three concealed hinges in a non-rebated leaf, silver (optionally black - subject to an additional charge); hinges supplied with and included in the price of the door frame
- lever tumbler lock in a rebated door leaf and a key-locked magnetic lock (lever tumbler lock as an option) in a non-rebated door leaf, thumb turn cylinder, economy, with a silver blockade; optionally, against an additional charge, a black or gold magnetic lock

## GLAZING

- frosted or transparent tempered glass as standard, and custom-made frosted or black VSG 221 laminated safety glass, plain on both sides
- possibility to change the glazing side to REVERSE (standard glazing for OBVERSE)

## EXTRA CHARGES

factory pre-drilled through holes for handles (split handles) ordered together with the door leaf

enhanced airflow trim, ventilation undercut standard or mini (p. 137)

"100" rebated and non-rebated door leaf

metal hinge casings in the rebated door leaf (brushed nickel, patina, polished chrome, polished brass, white and black)

VSG 221 laminated safety glass, plain on both sides

drop down seal <sup>1)</sup>

can be replaced with a black or golden magnetic lock for non-rebated door leaves

can be changed to hinges and strike plate in black or gold for non-rebated door leaves

magnetic stop (buffer) <sup>1)</sup>  
(available in six colours p. 137)

glulam timber stiles

## PAINTED



TITANIUM WHITE UV

## AVAILABLE SOLUTIONS (pp. 142-153)

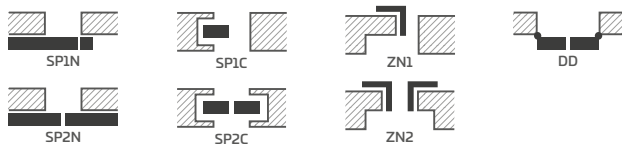

## AVAILABLE DOOR LEAF WIDTHS

60 70 80N<sup>2)</sup> 80 90 100

<sup>1)</sup> a stop will not allow a drop down seal and an enhanced airflow trim to be used, and vice versa

<sup>2)</sup> only for non-rebated door leaves



# BALDUR

REBATED, NON-REBATED AND REVERSE PAINTED DOORS



BALDUR 1 with CUBE PREMIUM handle, black matt, and VSG 441 laminated glass, black



BALDUR 1



BALDUR 2



BALDUR 3



BALDUR 4



BALDUR 5



BALDUR 6



BALDUR 7



BALDUR 8

BALDUR 7 with CUBE PREMIUM handle, black matt



## DESIGN

- rebated, non-rebated or reverse door leaf
- internal timber stiles and top rail, MDF bottom rail, covered with two HDF boards
- rigid honeycomb infill or solid core infill for additional charge
- optional door frame extension panels and a crossheads with pilasters are available for surcharge, pp. 139-141
- the door can be trimmed by a customer; go to p. 137 for details (not for BALDUR 1, 3, 5)

## FINISH

- door leaves and door frames coated with water-based UV hardened varnish for high resistance to adverse use conditions
- door leaf edge made in standard or non-rebated technology
- the BALDUR 1 sliding systems have a visible (17 mm high) aluminium or black coloured profile in the lower part of the glass pane

## HARDWARE

- three pin mortise hinges in a rebated door leaf
- three concealed hinges in the non-rebated leaf and two hinges in the reverse leaf (third for an extra charge) in silver (black for an extra charge); hinges are supplied and priced with the door frame
- a lever tumbler lock in the rebated door leaf and a magnetic lock (lever tumbler lock as an option) in the non-rebated door leaf, optionally: key-locked, thumb turn cylinder, economy or with a silver blockade; or optionally, for an extra charge, a black or golden magnetic lock
- a magnetic lock in the reversed-swing door, optionally: key-locked, thumb turn cylinder, economy or with a silver blockade; or optionally, for an extra charge, a black or golden magnetic lock

## GLAZING

- **BALDUR 1, 3, 5: VSG/ESG 441 laminated and tempered safety glass as standard, frosted or black, plain on both sides**
- fixed glazing widths: BALDUR 1 – 50 mm, BALDUR 3, 5 – 210 mm

## EXTRA CHARGES

reverse door leaf

solid core filling

enhanced airflow trim, ventilation undercut standard or mini (p. 137)

"100" rebated and non-rebated door leaf

additional bottom allowing the user to shorten the leaf up to 8 cm (not applicable to Baldur 1, 3, 5)

metal hinge casings in the rebated door leaf (brushed nickel, patina, polished chrome, polished brass, white and black)

drop down seal <sup>2)</sup> (not for BALDUR 1, 3, 5)

can be replaced with a black or golden magnetic lock for non-rebated and reverse leaves

can be changed to hinges and strike plate in black or gold for non-rebated door leaves

magnetic stop (buffer) <sup>2)</sup>  
(available in six colours p. 137)

PL2112 standard

## PAINTED



TITANIUM WHITE UV

## AVAILABLE SOLUTIONS<sup>1) 3)</sup> (pp. 142-153)

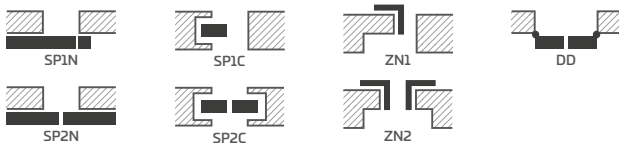

## AVAILABLE DOOR LEAF WIDTHS

60N<sup>5)</sup> 60 70N<sup>5)</sup> 70 80N<sup>4)</sup> 80 90N<sup>5)</sup> 90 100

## VENTILATION UNDERCUT

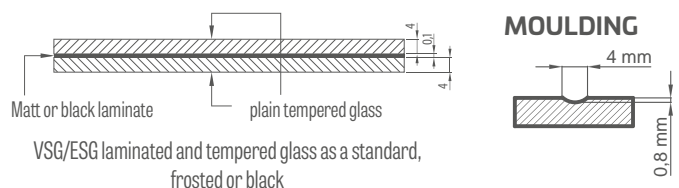
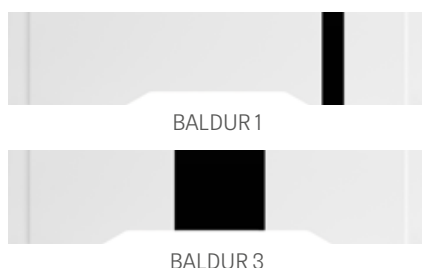

<sup>1)</sup> the BALDUR 1, 3, 5 models are not available with sliding systems or double doors

<sup>2)</sup> a stop will not allow a drop down seal and an enhanced airflow trim to be used, and vice versa

<sup>3)</sup> the BALDUR 1 model is not available with pocket systems

<sup>4)</sup> only for non-rebated and reversed swing doors

<sup>5)</sup> BALDUR 1 only, non-rebated and reversed swing



# ANUBIS

REBATED, NON-REBATED AND REVERSE PAINTED DOORS



ANUBIS 2, BELLA SLIM handle, round, glossy brass



ANUBIS 1



ANUBIS 2



ANUBIS 3



ANUBIS 4



ANUBIS 5

ANUBIS 3 with BELLA SLIM handle, round, shiny brass



## DESIGN

- rebated, non-rebated or reverse door leaf
- internal timber stiles and top rail, MDF bottom rail, covered with two HDF boards
- rigid honeycomb infill or solid core infill for additional charge
- optional door frame extension panels and a crossheads with pilasters are available for surcharge, pp. 139-141
- the door can be trimmed by a customer; go to p. 137 for details

## FINISH

- door leaves and door frames coated with water-based UV hardened varnish for high resistance to adverse use conditions
- door leaf edge made in standard or non-rebated technology

## HARDWARE

- three pin mortise hinges in a rebated door leaf
- three concealed hinges in the non-rebated leaf and two hinges in the reverse leaf (third for an extra charge) in silver (black for an extra charge); hinges are supplied and priced with the door frame
- a lever tumbler lock in the rebated door leaf and a magnetic lock (lever tumbler lock as an option) in the non-rebated door leaf, optionally: key-locked, thumb turn cylinder, economy or with a silver blockade; or optionally, for an extra charge, a black or golden magnetic lock
- a magnetic lock in the reversed-swing door, optionally: key-locked, thumb turn cylinder, economy or with a silver blockade; or optionally, for an extra charge, a black or golden magnetic lock

## MOULDING

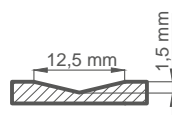

## EXTRA CHARGES

reverse door leaf

solid core filling

enhanced airflow trim, ventilation undercut standard or mini (p. 137)

"100" rebated and non-rebated door leaf

additional bottom rail (can be trimmed by a customer up to max 8 cm)

metal hinge casings in the rebated door leaf (brushed nickel, patina, polished chrome, polished brass, white and black)

drop down seal <sup>1)</sup>

can be replaced with a black or golden magnetic lock for non-rebated and reverse leaves

can be changed to hinges and strike plate in black or gold for non-rebated door leaves

magnetic stop (buffer) <sup>1)</sup>

(available in six colours p. 137)

PL2112 standard

## PAINTED



TITANIUM WHITE UV

## AVAILABLE SOLUTIONS (pp. 142-153)

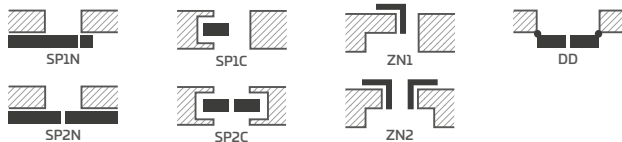

## AVAILABLE DOOR LEAF WIDTHS

60 70 80N<sup>2)</sup> 80 90 100

<sup>1)</sup> a stop will not allow a drop down seal and an enhanced airflow trim to be used, and vice versa

<sup>2)</sup> only for non-rebated and reversed swing doors



# UNO PREMIUM

REBATED, NON-REBATED AND REVERSE PAINTED DOORS



UNO PREMIUM, BELLA SLIM handle, shiny brass

Frame side view: non-rebated door, 8 cm architrave, frame joints at 90°



Frame side view: rebated door, 8 cm architrave, frame joints at 45°



Hinge side view: rebated door, 6 cm architrave, frame joints at 45°



UNO PREMIUM with black matt CUBE handle



## DESIGN

- rebated, non-rebated or reverse door leaf
- internal timber stiles and top rail, MDF bottom rail, covered with two HDF boards
- rigid honeycomb infill or solid core infill for additional charge
- optional door frame extension panels and a crossheads with pilasters are available for surcharge, pp. 139-141
- the door can be trimmed by a customer; go to p. 137 for details

## FINISH

- door leaves and door frames coated with water-based UV hardened varnish for high resistance to adverse use conditions
- Door leaf edge made in standard technology

## HARDWARE

- three pin mortise hinges in a rebated door leaf
- three concealed hinges in the non-rebated leaf and two hinges in the reverse leaf (third for an extra charge) in silver (black for an extra charge); hinges are supplied and priced with the door frame
- a lever tumbler lock in the rebated door leaf and a magnetic lock (lever tumbler lock as an option) in the non-rebated door leaf, optionally: key-locked, thumb turn cylinder, economy or with a silver blockade; or optionally, for an extra charge, a black or golden magnetic lock
- a magnetic lock in the reversed-swing door, optionally: key-locked, thumb turn cylinder, economy or with a silver blockade; or optionally, for an extra charge, a black or golden magnetic lock

## EXTRA CHARGES

reverse door leaf

solid core filling

enhanced airflow trim, ventilation undercut standard or mini (p. 137)

"100" rebated and non-rebated door leaf

"110" rebated and non-rebated door leaf

additional bottom rail (can be trimmed by a customer up to max 8 cm)

metal hinge casings in the rebated door leaf (brushed nickel, patina, polished chrome, polished brass, white and black)

drop down seal <sup>1)</sup>

can be replaced with a black or golden magnetic lock for non-rebated and reverse leaves

can be changed to hinges and strike plate in black or gold for non-rebated door leaves

magnetic stop (buffer) <sup>1)</sup>  
(available in six colours p. 137)

stainless steel porthole: "chrome" polished or "satin" brushed; frosted decormat glass, non-tinted glass; porthole ID 235 mm; external 350 mm)

PL2112 standard

## PAINTED



TITANIUM WHITE UV

## AVAILABLE SOLUTIONS (pp. 142-153)

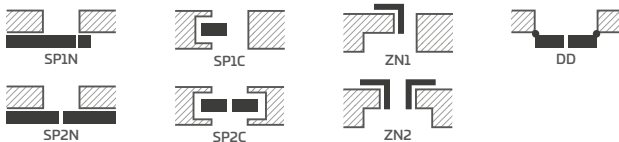

## AVAILABLE DOOR LEAF WIDTHS

60N<sup>2)</sup> 60 70N<sup>2)</sup> 70 80N<sup>2)</sup> 80 90N<sup>2)</sup> 90 100 110

<sup>1)</sup> a stop will not allow a drop down seal and an enhanced airflow trim to be used, and vice versa

<sup>2)</sup> only for non-rebated and reversed swing doors



# TURAN

REBATED, NON-REBATED AND REVERSE PAINTED DOORS



finalista konkursu

2019



TURAN 8, black matt CUBE handle



TURAN 1



TURAN 2



TURAN 3



TURAN 4



TURAN 5



TURAN 6



TURAN 7\*)



TURAN 8

NEW

\*) the photo shows the REVERS version

**NEW**

TURAN 6 with BELLA SLIM handle, round, black matt



## DESIGN

- rebated, non-rebated or reverse door leaf in STILE technology for an additional charge
- MDF stiles and rails coated with a facing layer and painted with UV-resistant varnish
- optional, at an extra charge, glulam timber stiles covered with HDF and MDF boards
- in TURAN 8 model, the panel is made of moisture-resistant HDF board 3 mm thick, applied to glass on both sides. The edge of the panel is always in the WHITE TITAN UV colour.<sup>3)</sup>
- 16 mm thick MDF panels, moulded and coated with UV resistant varnish
- optional door frame extension panels and a crossheads with pilasters are available for surcharge, pp. 139-141
- the door can be trimmed by a customer; go to p. 137 for details
- **TURAN 8 model** **NEW**

## FINISH

- door leaves and door frames coated with water-based UV hardened varnish for high resistance to adverse use conditions

## HARDWARE

- rebated door leaves: three silver 2-pin hinges adjusted horizontally
- three concealed hinges in a non-rebated leaf, silver (optionally black - subject to an additional charge); hinges supplied with and included in the price of the door frame
- lever tumbler lock in a rebated door leaf and a key-locked magnetic lock (lever tumbler lock as an option) in a non-rebated door leaf, thumb turn cylinder, economy, with a silver blockade; optionally, against an additional charge, a black or gold magnetic lock

## GLAZING

- TURAN 1 and TURAN 8 tempered glass 4 mm or for extra charge frosted or black VSG 221 laminated safety glass, plain on both sides
- TURAN 7 model available with a mirror on one side. Other side - varnished board WHITE TITANIUM UV. Obverse - mirror on the hinge side.
- TURAN 8 model fixed glazing width - 50 mm

## EXTRA CHARGES

factory pre-drilled through holes for handles (split handles) ordered together with the door leaf

reverse door leaf

enhanced airflow trim, ventilation undercut standard or mini (p. 137)

"100" rebated and non-rebated door leaf

metal hinge casings in the rebated door leaf (brushed nickel, patina, polished chrome, polished brass, white and black)

VSG 221 laminated safety glass, plain on both sides (applies to TURAN 1 and TURAN 8)

drop down seal<sup>1)</sup>

can be replaced with a black or golden magnetic lock for non-rebated door leaves

can be changed to hinges and strike plate in black or gold for non-rebated door leaves

magnetic stop (buffer)<sup>1)</sup>  
(available in six colours p. 137)

PL2112 standard

+15% on the door price before surcharges

glulam timber stiles

## PAINTED



TITANIUM WHITE UV

## AVAILABLE SOLUTIONS (pp. 142-153)

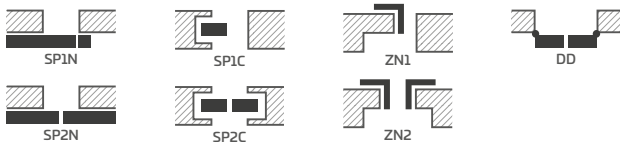

## AVAILABLE DOOR LEAF WIDTHS

60 70 80N<sup>2)</sup> 80 90 100

## MOULDING

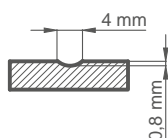

<sup>1)</sup> a stop will not allow a drop down seal and an enhanced airflow trim to be used, and vice versa

<sup>2)</sup> only for non-rebated door leaves



produkt rekomendowany  
do konkursu



2019

# MILDA

REBATED, NON-REBATED AND REVERSE PAINTED DOORS



MILDA 4, CUBE PREMIUM handle, black matt



MILDA 1



MILDA 2



MILDA 3



MILDA 4



MILDA 5

MILDA 2 with CUBE PREMIUM handle, black matt



## DESIGN

- rebated, non-rebated or reverse door leaf
- internal timber stiles and top rail, MDF bottom rail, covered with two HDF boards
- rigid honeycomb infill or solid core infill for additional charge
- optional door frame extension panels and a crossheads with pilasters are available for surcharge, pp. 139-141
- the door can be trimmed by a customer; go to p. 137 for details

## FINISH

- door leaves and door frames coated with water-based UV hardened varnish for high resistance to adverse use conditions
- door leaf edge made in standard or non-rebated technology

## HARDWARE

- three pin mortise hinges in a rebated door leaf
- three concealed hinges in the non-rebated leaf and two hinges (third for an extra charge) in the reverse swing leaf in silver (black for an extra charge); hinges are supplied and priced with the door frame
- a lever tumbler lock in the rebated door leaf and a magnetic lock (lever tumbler lock as an option) in the non-rebated door leaf, optionally: key-locked, thumb turn cylinder, economy or with a silver blockade; or optionally, for an extra charge, a black or golden magnetic lock
- a magnetic lock in the reversed-swing door, optionally: key-locked, thumb turn cylinder, economy or with a silver blockade; or optionally, for an extra charge, a black or golden magnetic lock

## MOULDING

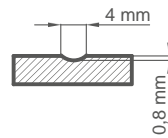

## EXTRA CHARGES

reverse door leaf

solid core filling

enhanced airflow trim, ventilation undercut standard or mini (p. 137)

"100" rebated and non-rebated door leaf

additional bottom rail (can be trimmed by a customer up to max 8 cm)

metal hinge casings in the rebated door leaf (brushed nickel, patina, polished chrome, polished brass, white and black)

drop down seal <sup>1)</sup>

can be replaced with a black or golden magnetic lock for non-rebated and reverse leaves

can be changed to hinges and strike plate in black or gold for non-rebated door leaves

magnetic stop (buffer) <sup>1)</sup>

(available in six colours p. 137)

PL2112 standard

## PAINTED



TITANIUM WHITE UV

## AVAILABLE SOLUTIONS (pp. 142-153)

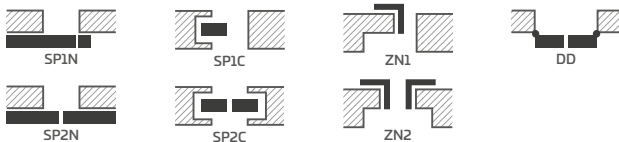

## AVAILABLE DOOR LEAF WIDTHS

60 70 80N<sup>2)</sup> 80 90 100

<sup>1)</sup> a stop will not allow a drop down seal and an enhanced airflow trim to be used, and vice versa

<sup>2)</sup> only for non-rebated and reversed swing doors



# SYLENA

REBATED, NON-REBATED AND REVERSE PAINTED DOORS



SYLENA 5, handle: BELLA SLIM, shiny brass



SYLENA 1



SYLENA 2



SYLENA 3



SYLENA 4



SYLENA 5



SYLENA 6



SYLENA 7



SYLENA 8

SYLENA 3 with BELLA SLIM handle, round, black matt



## DESIGN

- rebated, non-rebated or reverse door leaf
- internal timber stiles and top rail, MDF bottom rail, covered with two HDF boards
- rigid honeycomb infill or solid core infill for additional charge
- optional door frame extension panels and a crossheads with pilasters are available for surcharge, pp. 139-141
- the door can be trimmed by a customer; go to p. 137 for details

## FINISH

- door leaves and door frames coated with water-based UV hardened varnish for high resistance to adverse use conditions
- door leaf edge made in standard or non-rebated technology

## HARDWARE

- three pin mortise hinges in a rebated door leaf
- three concealed hinges in the non-rebated leaf and two hinges (third for an extra charge) in the reverse swing leaf in silver (black for an extra charge); hinges are supplied and priced with the door frame
- a lever tumbler lock in the rebated door leaf and a magnetic lock (lever tumbler lock as an option) in the non-rebated door leaf, optionally: key-locked, thumb turn cylinder, economy or with a silver blockade; or optionally, for an extra charge, a black or golden magnetic lock
- a magnetic lock in the reversed-swing door, optionally: key-locked, thumb turn cylinder, economy or with a silver blockade; or optionally, for an extra charge, a black or golden magnetic lock

## MOULDING

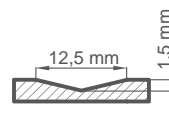

## EXTRA CHARGES

reverse door leaf

solid core filling

enhanced airflow trim, ventilation undercut standard or mini (p. 137)

"100" rebated and non-rebated door leaf

additional bottom rail (can be trimmed by a customer up to max 8 cm)

metal hinge casings in the rebated door leaf (brushed nickel, patina, polished chrome, polished brass, white and black)

drop down seal <sup>1)</sup>

can be replaced with a black or golden magnetic lock for non-rebated and reverse leaves

can be changed to hinges and strike plate in black or gold for non-rebated door leaves

magnetic stop (buffer) <sup>1)</sup>

(available in six colours p. 137)

PL2112 standard

## PAINTED



TITANIUM WHITE UV

## AVAILABLE SOLUTIONS (pp. 142-153)

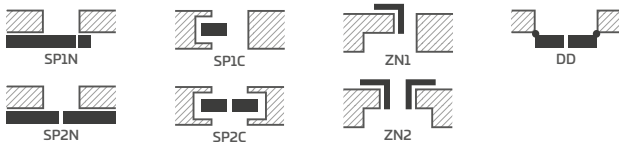

## AVAILABLE DOOR LEAF WIDTHS

60 70 80N <sup>2)</sup> 80 90 100

<sup>1)</sup> a stop will not allow a drop down seal and an enhanced airflow trim to be used, and vice versa

<sup>2)</sup> only for non-rebated and reversed swing doors



# INLAYS

DECORATIVE INSERT FLUSH WITH THE FACING SURFACE



ALTAMURA 1, BLACK ST CPL facing layer; inlay LUX 421, handle CUBE PREMIUM

**NEW**

LUX INLAY **BLACK**



inlay LUX 217



inlay LUX 218



inlay LUX 219



inlay LUX 220



inlay LUX 221



inlay LUX 203



inlay LUX 204



inlay LUX 212



inlay LUX 213



inlay LUX 207



inlay LUX 214



inlay LUX 216

Door frame: BLACK ST CPL Door leaf: OAK CLASSIC CPL

**INLAYS** are located on both sides of the leaf and are flush with its surface.

The inlay width is 8 mm or 50 mm.

Available colours of the LUX INLAY:  
brushed steel, black, brushed gold, oak (compatible with OAK CLASSIC CPL 0.2 & 0.7), brushed copper.

You can order the presented INLAYS as options for an extra charge on the following models available to PL and PL2112 standards (if available):

- UNO PREMIUM facing
- ALTAMURA 1
- FORTECA RC2 & RC3
- HERSE SET EKO 30 dB
- HERSE SET 32 dB
- HERSE SET AKUSTIC 39 dB
- LEDA EI30, EI60
- HYPERION EI30 RC2

The pictures show a non-rebated door with an economy lock, the lock positions may vary on other door types.

# INLAYS

DECORATIVE INSERT FLUSH WITH THE FACING SURFACE

**NEW**

LUX INLAY **OAK**



inlay LUX 317



inlay LUX 318



inlay LUX 319



inlay LUX 320



inlay LUX 321



inlay LUX 303



inlay LUX 304



inlay LUX 312



inlay LUX 313



inlay LUX 307



inlay LUX 314



inlay LUX 316

Door frame: OAK CLASSIC CPL 0.2 Door leaf: WHITE ST CPL

**INLAYS** are located on both sides of the leaf and are flush with its surface.

The inlay width is 8 mm or 50 mm.

Available colours of the LUX INLAY:  
brushed steel, black, brushed gold, oak (compatible with OAK CLASSIC CPL 0.2 & 0.7), brushed copper.

You can order the presented INLAYS as options for an extra charge on the following models available to PL and PL2112 standards (if available):

- UNO PREMIUM facing
- ALTAMURA 1
- FORTECA RC2 & RC3
- HERSE SET EKO 30 dB
- HERSE SET 32 dB
- HERSE SET AKUSTIC 39 dB
- LEDA EI30, EI60
- HYPERION EI30 RC2

The pictures show a non-rebated door with an economy lock, the lock positions may vary on other door types.

**NEW**

LUX INLAY **BRUSHED GOLD**

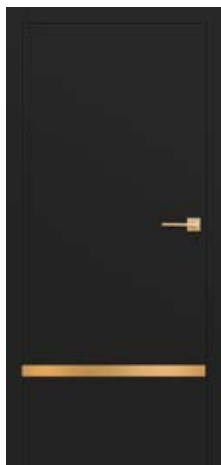

inlay LUX 417

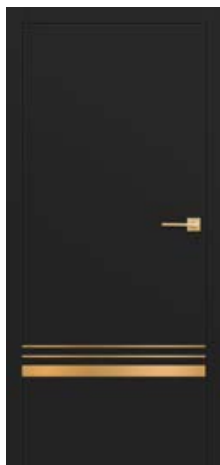

inlay LUX 418

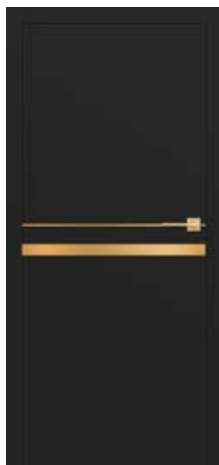

inlay LUX 419

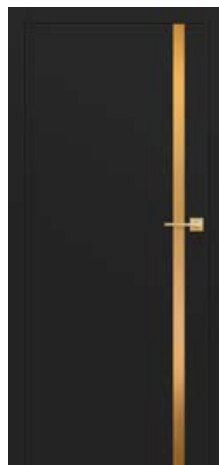

inlay LUX 420



inlay LUX 421

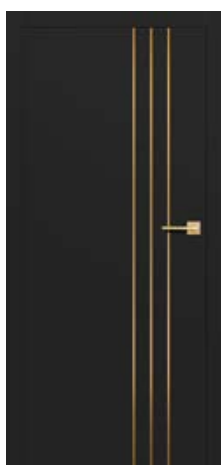

inlay LUX 403

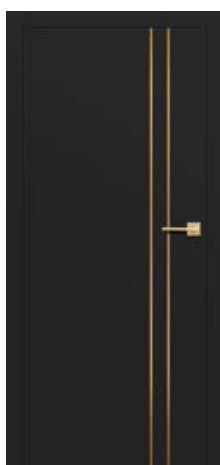

inlay LUX 404

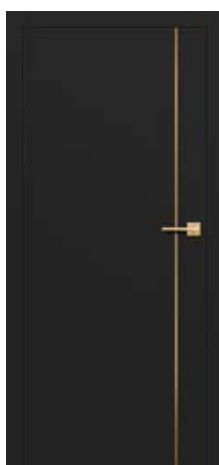

inlay LUX 412



inlay LUX 413

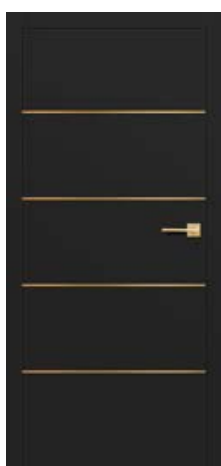

inlay LUX 407



inlay LUX 414

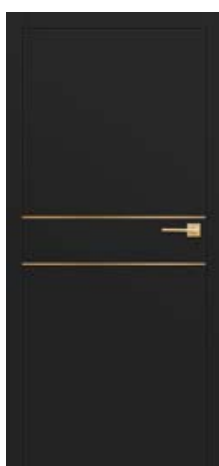

inlay LUX 416

Door frame and leaf BLACK ST CPL

**INLAYS** are located on both sides of the leaf and are flush with its surface.

The inlay width is 8 mm or 50 mm.

Available colours of the LUX INLAY:  
brushed steel, black, brushed gold, oak (compatible with OAK CLASSIC CPL 0.2 & 0.7), brushed copper.

You can order the presented INLAYS as options for an extra charge on the following models available to PL and PL2112 standards (if available):

- UNO PREMIUM facing
- ALTAMURA 1
- FORTECA RC2 & RC3
- HERSE SET EKO 30 dB
- HERSE SET 32 dB
- HERSE SET AKUSTIC 39 dB
- LEDA EI30, EI60
- HYPERION EI30 RC2

The pictures show a non-rebated door with an economy lock, the lock positions may vary on other door types.

# INLAYS

DECORATIVE INSERT FLUSH WITH THE FACING SURFACE

**NEW**

## LUX INLAY BRUSHED STEEL

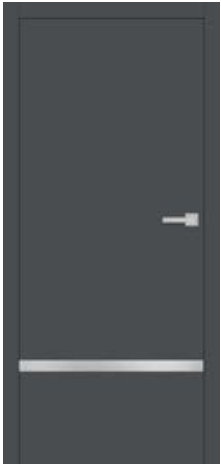

inlay LUX 117

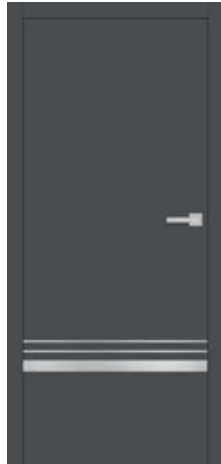

inlay LUX 118



inlay LUX 119



inlay LUX 120

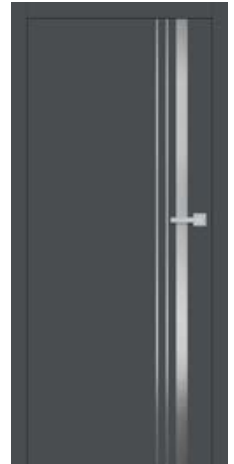

inlay LUX 121

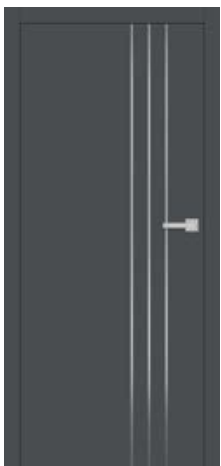

inlay LUX 103



inlay LUX 104



inlay LUX 112



inlay LUX 113

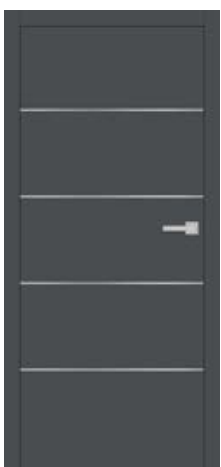

inlay LUX 107

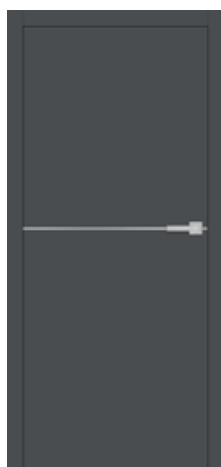

inlay LUX 114

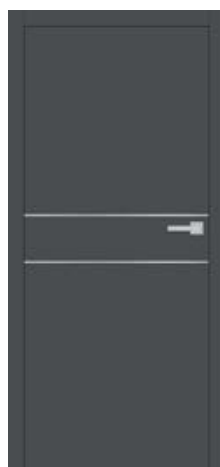

inlay LUX 116

Door frame and leaf ANTHRACITE ST CPL

**INLAYS** are located on both sides of the leaf and are flush with its surface.

The inlay width is 8 mm or 50 mm.

Available colours of the LUX INLAY:  
brushed steel, black, brushed gold, oak (compatible with OAK CLASSIC CPL 0.2 & 0.7), brushed copper.

You can order the presented INLAYS as options for an extra charge on the following models available to PL and PL2112 standards (if available):

- UNO PREMIUM facing
- ALTAMURA 1
- FORTEGA RC2 & RC3
- HERSE SET EKO 30 dB
- HERSE SET 32 dB
- HERSE SET AKUSTIC 39 dB
- LEDA EI30, EI60
- HYPERION EI30 RC2

The pictures show a non-rebated door with an economy lock, the lock positions may vary on other door types.

INLAY LUX **BRUSHED COPPER**

**NEW**



inlay LUX 517



inlay LUX 518



inlay LUX 519



inlay LUX 520



inlay LUX 521



inlay LUX 503



inlay LUX 504



inlay LUX 512



inlay LUX 513



inlay LUX 507



inlay LUX 514



inlay LUX 516

Door frame and leaf NAVY BLUE ST CPL

**INLAYS** are located on both sides of the leaf and are flush with its surface.

The inlay width is 8 mm or 50 mm.

Available colours of the LUX INLAY:

brushed steel, black, brushed gold, oak (compatible with OAK CLASSIC CPL 0.2 & 0.7), brushed copper.

You can order the presented INLAYS as options for an extra charge on the following models available to PL and PL2112 standards (if available):

- UNO PREMIUM facing
- ALTAMURA 1
- FORTECA RC2 & RC3
- HERSE SET EKO 30 dB
- HERSE SET 32 dB
- HERSE SET AKUSTIC 39 dB
- LEDA EI30, EI60
- HYPERION EI30 RC2

The pictures show a non-rebated door with an economy lock, the lock positions may vary on other door types.

# BALDUR

REBATED, NON-REBATED AND REVERSE INTERIOR DOORS



BALDUR 1, NATUR OAK PREMIUM facing layer; door frame facing layer: BLACK ST CPL, handle: QUBIK, black matt

BALDUR 1 in OAK RETRO CPL facing layer; door frame: BLACK ST CPL with CUBE PREMIUM handle, black matt



BALDUR 1

BALDUR 3 in OAK ST CPL facing layer; door frame: BLACK ST CPL with CUBE PREMIUM handle, black matt



BALDUR 3

BALDUR 1 in OAK CLASSIC CPL facing layer; door frame: BLACK ST CPL with CUBE PREMIUM handle, black matt



BALDUR 1

## DESIGN

- rebated, non-rebated or reverse door leaf
- internal timber stiles and top rail, MDF bottom rail, covered with two HDF boards
- rigid honeycomb infill or solid core infill for additional charge
- optional door frame extension panels and a crossheads with pilasters are available for surcharge, pp. 139-141

## FINISH

- HDF board in PREMIUM or CPL facing
- leaf edge made in the standard rebated or non-rebated technology with CPL 0.2 laminates, faced with the ABS edging, and in the same colour as the leaf only or, against an additional charge, with a standard black edge
- reverse door leaf only in with the STANDARD edge and with the PREMIUM and ST CPL facings
- the door edge faced with edging in the same colour as the door leaf plane or optionally in black plain edging (black edging with horizontal grain for the TRANSVERSE NATUR OAK PREMIUM facing). Door edge faced with black layers around a part of the circumference (two vertical edges and the top one) and next to the glass.
- rebated and non-rebated door leaf BALDUR 1 only for the WHITE ST CPL facing made optionally in the Soft technology (invisible longitudinal edge joints of the facing), requiring the use of a solid core at an extra charge. The Soft technology is not included in the PL2112 standard.
- the BALDUR 1 sliding systems have a visible 17 mm high aluminium or black coloured profile in the lower part of the glass pane

## HARDWARE

- three pin mortise hinges in a rebated door leaf
- three concealed hinges in the non-rebated leaf and two hinges (third for an extra charge) in the reverse swing leaf in silver (black for an extra charge); hinges are supplied and priced with the door frame
- a lever tumbler lock in the rebated door leaf and a magnetic lock (lever tumbler lock as an option) in the non-rebated door leaf, optionally: key-locked, thumb turn cylinder, economy or with a silver blockade; or optionally, for an extra charge, a black or golden magnetic lock
- a magnetic lock in the reversed-swing door; optionally: key-locked, thumb turn cylinder, economy or with a silver blockade; or optionally, for an extra charge, a black or golden magnetic lock

## GLAZING

- BALDUR 1, 3: 8 mm tempered frosted glass or VSG/ESG 441 safety glass, frosted or black, plain on both sides

## CPL



## PREMIUM

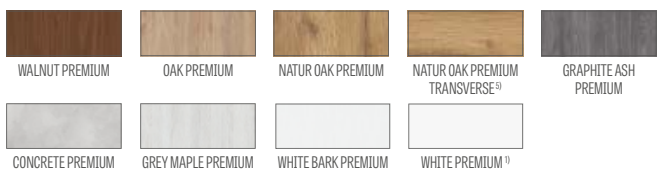

## EXTRA CHARGES

### reverse door leaf

(unavailable for CPL 0.2 and for BALDUR 1 with SOFT edge)

solid core filling

enhanced airflow trim, ventilation undercut standard or mini (p. 137)

"100" rebated and non-rebated door leaf

frosted or black VSG/ESG 441 glazing

metal hinge casings in the rebated door leaf (brushed nickel, patina, polished chrome, polished brass, white and black)

black door leaf edge finish

can be replaced with a black or golden magnetic lock for non-rebated and reverse leaves

can be changed to hinges and strike plate in black or gold for non-rebated door leaves

magnetic stop (buffer)

(available in six colours p. 137)

PL2112 standard

+ 15% on the door price before surcharges

## AVAILABLE DOOR LEAF WIDTHS



## AVAILABLE SOLUTIONS<sup>3)</sup> (pp. 142-153)



## EDGE FINISH TYPES



BLACK PLAIN DOOR LEAF EDGE FINISH



BLACK HORIZONTAL DOOR LEAF EDGE FINISH

## VENTILATION UNDERCUT



<sup>1)</sup> plain white facing imitating a painted surface

<sup>2)</sup> special **AntiFinger** coating to reduce dirt and fingerprints

<sup>3)</sup> the BALDUR 3 model not available in sliding systems or double doors

<sup>4)</sup> only soft version for BALDUR 1 rebated and non-rebated with WHITE ST CPL facing layer and only available at an extra charge with solid core (the Soft option not included in the PL2112 standard)

<sup>5)</sup> comes complete with the NATUR OAK PREMIUM door frame

<sup>6)</sup> only for non-rebated and reversed swing doors

<sup>7)</sup> only BALDUR 1 non-rebated and reversed swing, not available in soft edge

<sup>8)</sup> until stock lasts

# UNO PREMIUM

REBATED, NON-REBATED AND REVERSE INTERIOR DOORS



UNO PREMIUM, leaf with OAK PREMIUM facing layer, BLACK ST CPL door frame, CUBE PREMIUM handle, black matt

UNO PREMIUM in TRANSVERSE NATUR OAK PREMIUM with CUBE handle, black matt



UNO PREMIUM in GRAPHITE ASH PREMIUM facing layer with CUBE handle, black matt



UNO PREMIUM with WALNUT PREMIUM facing layer with CUBE handle, black matt



UNO PREMIUM with WHITE PREMIUM facing layer with BELLA SLIM handle, black matt



## DESIGN

- rebated, non-rebated or reverse door leaf
- internal timber stiles and top rail, MDF bottom rail, covered with two HDF boards
- rigid honeycomb infill
- solid core filling for additional charge
- optional door frame extension panels and a crossheads with pilasters are available for surcharge, pp. 139-141
- the door can be trimmed by a customer, go to p. 137 for details

## FINISH

- HDF board with PREMIUM facing
- door leaf edge made in standard rebated or non-rebated technology
- the door edge faced with edging in the same colour as the door leaf plane or optionally in black plain edging (black edging with horizontal grain for the TRANSVERSE NATUR OAK PREMIUM facing)
- insert (inlay) colour: brushed steel, black, brushed gold and CLASSIC OAK CPL with a width of 8 mm or 50 mm flush with the door leaf plane, made on both sides of the leaf, pp. 86-91

## HARDWARE

- three pin mortise hinges in a rebated door leaf
- three concealed hinges in the non-rebated leaf and two hinges (third for an extra charge) in the reverse swing leaf in silver (black for an extra charge); hinges are supplied and priced with the door frame
- a lever tumbler lock in the rebated door leaf and a magnetic lock (lever tumbler lock as an option) in the non-rebated door leaf, optionally: key-locked, thumb turn cylinder, economy or with a silver blockade; or optionally, for an extra charge, a black or golden magnetic lock
- a magnetic lock in the reversed-swing door, optionally: key-locked, thumb turn cylinder, economy or with a silver blockade; or optionally, for an extra charge, a black or golden magnetic lock

## PREMIUM

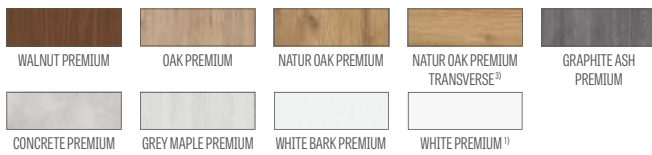

## AVAILABLE DOOR LEAF WIDTHS



## AVAILABLE SOLUTIONS (pp. 142-153)

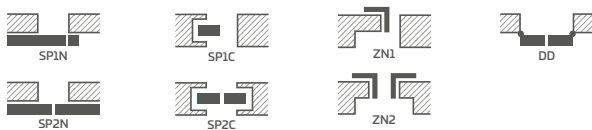

## EDGE FINISH TYPES



BLACK PLAIN DOOR LEAF  
EDGE FINISH  
(at an extra charge)



BLACK HORIZONTAL  
DOOR LEAF EDGE FINISH  
(at an extra charge)



## EXTRA CHARGES

reverse door leaf

solid core filling

door closer reinforcement

arm door closer (silver, black, white, brown)

additional bottom rail (can be trimmed by a customer up to max 8 cm )

round and square metal sleeves (4 pcs);

brushed nickel or patina finish, white and black

plastic woodgrain sleeves (4 pcs)

enhanced airflow trim, ventilation undercut standard or mini (p. 137) or ventilation grille

"100" rebated and non-rebated door leaf

"110" rebated and non-rebated door leaf

drop down seal <sup>2)</sup>

metal hinge casings in the rebated door leaf (brushed nickel, patina, polished chrome, polished brass, white and black)

stainless steel porthole: "chrome" polished or "satin" brushed; frosted decormat glass, non-tinted glass; porthole ID 235 mm external 350 mm)

black door leaf edge finish

can be replaced with a black or golden magnetic lock for non-rebated and reverse leaves

can be changed to hinges and strike plate in black or gold for non-rebated door leaves

magnetic stop (buffer) <sup>2)</sup>

(available in six colours p. 137)

LUX inlay; available versions p. 86-91

PL2112 standard

+ 15% on the door price before surcharges

<sup>1)</sup> plain white facing imitating a painted surface

<sup>2)</sup> a stop will not allow a drop down seal and an enhanced airflow trim to be used, and vice versa

<sup>3)</sup> comes complete with the NATUR OAK PREMIUM door frame

<sup>4)</sup> only for non-rebated and reversed swing doors



# ALTAMURA

REBATED, NON-REBATED AND REVERSE INTERIOR DOORS



ALTAMURA 1, OAK CLASSIC CPL facing layer, handle: TOPAZ black matt, porthole black matt



ALTAMURA 1



ALTAMURA 2



ALTAMURA 3



ALTAMURA 4



Middle panel

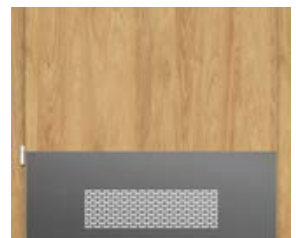

grille panel



ALTAMURA 5



ALTAMURA 6



ALTAMURA 7



ALTAMURA 8

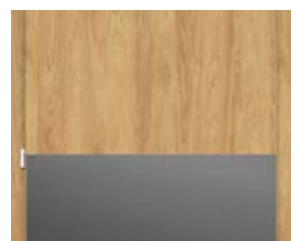

Bottom panel

## DESIGN

- rebated, non-rebated or reverse door leaf
- MDF stiles and rails covered with two HDF boards in GREKO facing layers
- internal timber stiles and top rail, MDF bottom rail, covered with two HDF boards in CPL and PREMIUM facing layer
- rigid honeycomb infill or solid core infill for additional charge
- optional door frame extension panels and a crossheads with pilasters are available for surcharge, pp. 139-141
- the door can be trimmed by a customer, go to p. 137 for details

## FINISH

- HDF board with a facing layer
- door leaf edge made in the STANDARD technology
- CPL 0.2 & 0.7 laminates available only with the STANDARD edge with the ABS edging in the same colour as the door leaf only or, against an additional charge, with a standard black edge
- edge (in standard or non-rebated finish) faced with an edging in the same colour as the surface or, optionally, in plain black (black edging with transverse NATUR OAK PREMIUM, a black edge with a transverse structure)
- For ALTAMURA 1, inlays are available for surcharge, as shown on pp. 86-91

## HARDWARE

- three pin mortise hinges in a rebated door leaf
- three concealed hinges in the non-rebated leaf and two hinges in the reverse leaf (third for an extra charge) in silver (black or gold for an extra charge); hinges are supplied and priced with the door frame
- a lever tumbler lock in the rebated door leaf and a magnetic lock (lever tumbler lock as an option) in the non-rebated door leaf, optionally: key-locked, thumb turn cylinder, economy or with a silver blockade; or optionally, for an extra charge, a black or golden magnetic lock
- a magnetic lock in the reversed-swing door; optionally: key-locked, thumb turn cylinder, economy or with a silver blockade; or optionally, for an extra charge, a black or golden magnetic lock

## GLAZING

- **tempered frosted Decormat glass as standard**, clear or, for an extra charge, frosted VSG 221 safety glass, plain on both sides
- possibility to change the glazing side to REVERSE (standard glazing for OBVERSE)

## EXTRA CHARGES

**reverse door leaf** (unavailable for CPL 0.2 and 0.7)

solid core filling

door closer reinforcement

arm door closer (silver, black, white, brown)

additional bottom rail (can be trimmed by a customer up to max 8 cm)

enhanced airflow trim, ventilation undercut standard or mini (p. 137) or ventilation grille

metal round or square ventilation sleeves (4 pcs);

brushed nickel or patina finish in white or black

plastic sleeves

"100" rebated and non-rebated door leaf

"110" rebated and non-rebated door leaf

frosted VSG 221 laminated glass

drop down seal <sup>2)</sup>

metal hinge casings in the rebated door leaf (brushed nickel, patina, polished chrome, polished brass, white and black)

ALTAMURA 1: stainless steel porthole: polished "chrome" or brushed "satin" and black matt; frosted decormat glass, non-tinted glass; porthole diameter: internal: 235 mm; external 350 mm)

stainless steel panel (fitted on both sides in the rebated STANDARD door leaves only), height 300 mm

- lower Altamura 1, 3, 4, 6, 8

- central Altamura 1, 4

- lower with ventilation Altamura 1, 3, 4, 6, 8

black door leaf edge finish

can be replaced with a black or golden magnetic lock for non-rebated and reverse leaves

can be changed to hinges and strike plate in black or gold for non-rebated door leaves

magnetic stop (buffer) <sup>2)</sup>

(available in six colours p. 137)

ALTAMURA 1 model: LUX inlay; available versions p. 86-91

PL2112 standard

+ 15% on the door price before surcharges

## GREKO

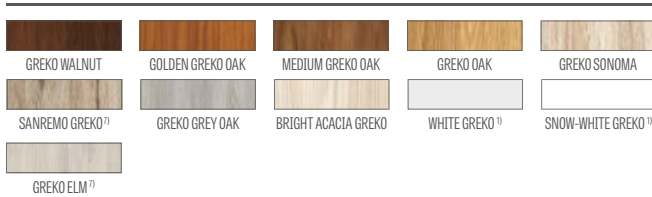

## CPL



## PREMIUM



## AVAILABLE DOOR LEAF WIDTHS



## AVAILABLE SOLUTIONS (pp. 142-153)

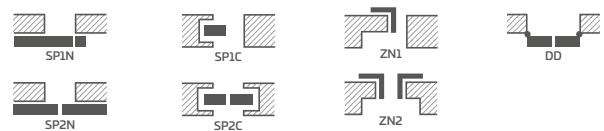

## EDGE FINISH TYPES

## GLASS FRAME

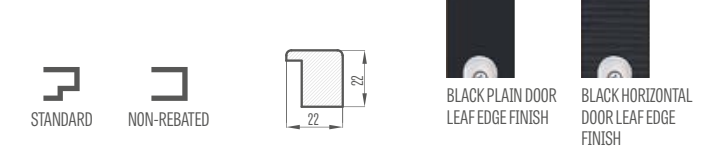

<sup>1)</sup> plain white facing imitating a painted surface

<sup>2)</sup> a stop will not allow a drop down seal and an enhanced airflow trim to be used, and vice versa

<sup>3)</sup> special **AntiFinger** coating to reduce dirt and fingerprints

<sup>4)</sup> comes complete with the NATUR OAK PREMIUM door frame

<sup>5)</sup> only for non-rebated and reversed swing doors

<sup>6)</sup> ALTAMURA 1 only, non-rebated and reversed swing

<sup>7)</sup> until stock lasts

# ANSEDONIA

REBATED, NON-REBATED AND REVERSE INTERIOR DOORS



ANSEDONIA 4, GREY OAK ST CPL facing layer, handle: TOPAZ stainless steel handle



ANSEDONIA 1



ANSEDONIA 2



ANSEDONIA 3



ANSEDONIA 4



ANSEDONIA 5



ANSEDONIA 6



ANSEDONIA 7



ANSEDONIA 8



ANSEDONIA 9



ANSEDONIA 10



ANSEDONIA 11



ANSEDONIA 12

## DESIGN

- rebated, non-rebated or reverse door leaf
- MDF stiles and rails covered with two HDF boards in GREKO facing layers
- internal timber stiles and top rail, MDF bottom rail, covered with two HDF boards in CPL and PREMIUM facing layer
- rigid honeycomb infill or solid core infill for additional charge
- optional door frame extension panels and a crossheads with pilasters are available for surcharge, pp. 139-141
- the door can be trimmed by a customer, go to p. 137 for details

## FINISH

- HDF board with a facing layer
- door leaf edge made in the STANDARD technology.
- CPL 0.2 & 0.7 laminates available only with the STANDARD edge with the ABS edging in the same colour as the door leaf only or, against an additional charge, with a standard black edge
- edge (in standard or non-rebated finish) faced with an edging in the same colour as the surface or, optionally, in plain black (black edging with transverse NATUR OAK PREMIUM, a black edge with a transverse structure)

## HARDWARE

- three pin mortise hinges in a rebated door leaf
- three concealed hinges in the non-rebated leaf and two hinges in the reverse leaf (third for an extra charge) in silver (black or gold for an extra charge); hinges are supplied and priced with the door frame
- a lever tumbler lock in the rebated door leaf and a magnetic lock (lever tumbler lock as an option) in the non-rebated door leaf, optionally: key-locked, thumb turn cylinder, economy or with a silver blockade; or optionally, for an extra charge, a black or golden magnetic lock
- a magnetic lock in the reversed-swing door, optionally: key-locked, thumb turn cylinder, economy or with a silver blockade; or optionally, for an extra charge, a black or golden magnetic lock

## GLAZING

- **tempered frosted Decormat glass as standard**, clear or, for an extra charge, frosted VSG 221 safety glass, plain on both sides
- possibility to change the glazing side to REVERSE (standard glazing for OBVERSE)

## EXTRA CHARGES

### reverse door leaf

(not available in CPL 0.2 & 0.7)

solid core filling

door closer reinforcement

arm door closer (silver, black, white, brown)

additional bottom rail (can be trimmed by a customer up to max 8 cm)

enhanced airflow trim, ventilation undercut standard or mini (p. 137) or ventilation grille

plastic sleeves

metal round or square ventilation sleeves (4 pcs);

brushed nickel or patina finish in white or black

"100" rebated and non-rebated door leaf

frosted VSG 221 laminated glass, plain on both sides

drop down seal <sup>2)</sup>

metal hinge casings in the rebated door leaf (brushed nickel, patina, polished chrome, polished brass, white and black)

black door leaf edge finish

can be replaced with a black or golden magnetic lock for non-rebated and reverse leaves

can be changed to hinges and strike plate in black or gold for non-rebated door leaves

magnetic stop (buffer) <sup>2)</sup>

(available in six colours p. 137)

PL2112 standard

+ 15% on the door price before surcharges

## GREKO



## CPL



## PREMIUM

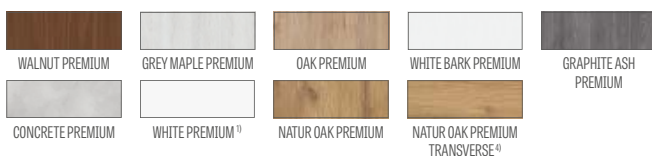

## AVAILABLE DOOR LEAF WIDTHS



## AVAILABLE SOLUTIONS (pp. 142-153)

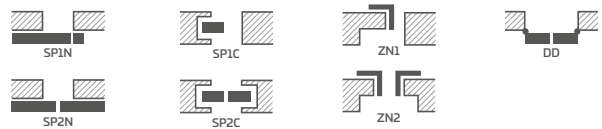

## EDGE FINISH TYPES

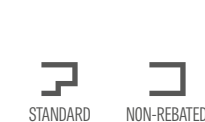

## GLASS FRAME

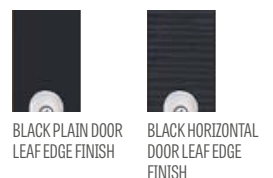

<sup>1)</sup> plain white facing imitating a painted surface

<sup>2)</sup> a stop will not allow a drop down seal and an enhanced airflow trim to be used, and vice versa

<sup>3)</sup> special **AntiFinger** coating to reduce dirt and fingerprints

<sup>4)</sup> comes complete with the NATUR OAK PREMIUM door frame

<sup>5)</sup> only for non-rebated and reversed swing doors

<sup>6)</sup> until stock lasts

# LORIENT

REBATED, NON-REBATED AND REVERSE INTERIOR DOORS



LORIENT 1, GREY MAPLE PREMIUM facing layer; handle: TOPAZ stainless steel handle



LORIENT 1



LORIENT 2



LORIENT 3



LORIENT 4



LORIENT 5



LORIENT 6



LORIENT 7



LORIENT 8



LORIENT 9



LORIENT 10



LORIENT 11



LORIENT 12

## DESIGN

- rebated, non-rebated or reverse door leaf
- MDF stiles and rails covered with two HDF boards in GREKO facing layers
- internal timber stiles and top rail, MDF bottom rail, covered with two HDF boards in CPL and PREMIUM facing layer
- rigid honeycomb infill or solid core infill for additional charge
- optional door frame extension panels and a crossheads with pilasters are available for surcharge, pp. 139-141
- the door can be trimmed by a customer, go to p. 137 for details

## FINISH

- HDF board with a facing layer
- door leaf edge made in the STANDARD technology.
- edge (in standard or non-rebated finish) faced with an edging in the same colour as the surface or, optionally, in plain black (black edging with transverse NATUR OAK PREMIUM, a black edge with a transverse structure)

## HARDWARE

- three pin mortise hinges in a rebated door leaf
- three concealed hinges in the non-rebated leaf and two hinges in the reverse leaf (third for an extra charge) in silver (black or gold for an extra charge); hinges are supplied and priced with the door frame
- a lever tumbler lock in the rebated door leaf and a magnetic lock (lever tumbler lock as an option) in the non-rebated door leaf, optionally: key-locked, thumb turn cylinder, economy or with a silver blockade; or optionally, for an extra charge, a black or golden magnetic lock
- a magnetic lock in the reversed-swing door; optionally: key-locked, thumb turn cylinder, economy or with a silver blockade; or optionally, for an extra charge, a black or golden magnetic lock

## GLAZING

- **tempered frosted Decormat glass as standard**, clear or, for an extra charge, frosted VSG 221 safety glass, plain on both sides
- possibility to change the glazing side to REVERSE (standard glazing for OBVERSE)

## EXTRA CHARGES

reverse door leaf

solid core filling

door closer reinforcement

arm door closer (silver, black, white, brown)

additional bottom rail (can be trimmed by a customer up to max 8 cm)

enhanced airflow trim, ventilation undercut standard or mini (p. 137) or ventilation grille

plastic sleeves

metal round or square ventilation sleeves (4 pcs);  
brushed nickel or patina finish in white or black

"100" rebated and non-rebated door leaf

frosted VSG 221 laminated glass, plain on both sides

drop down seal <sup>2)</sup>

metal hinge casings in the rebated door leaf (brushed nickel, patina, polished chrome, polished brass, white and black)

black door leaf edge finish

can be replaced with a black or golden magnetic lock for non-rebated and reverse leaves

can be changed to hinges and strike plate in black or gold for non-rebated door leaves

magnetic stop (buffer) <sup>2)</sup>

(available in six colours p. 137)

PL2112 standard

+ 15% on the door price before surcharges

## GREKO



## CPL



## PREMIUM

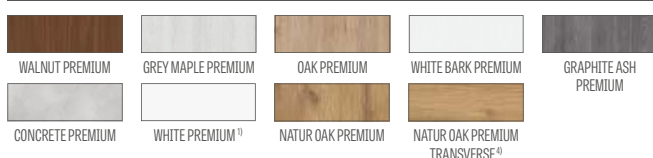

## AVAILABLE DOOR LEAF WIDTHS



## AVAILABLE SOLUTIONS (pp. 142-153)

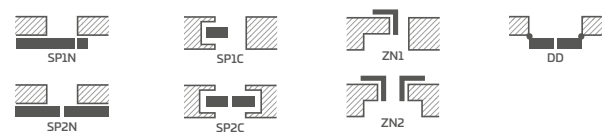

## EDGE FINISH TYPES



## GLASS FRAME

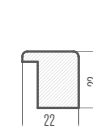

BLACK PLAIN DOOR LEAF EDGE FINISH



BLACK HORIZONTAL DOOR LEAF EDGE FINISH

<sup>1)</sup> plain white facing imitating a painted surface

<sup>2)</sup> a stop will not allow a drop down seal and an enhanced airflow trim to be used, and vice versa

<sup>3)</sup> special **AntiFinger** coating to reduce dirt and fingerprints

<sup>4)</sup> comes complete with the NATUR OAK PREMIUM door frame

<sup>5)</sup> only for non-rebated and reversed swing doors

<sup>6)</sup> until stock lasts

# MENTON

REBATED, NON-REBATED AND REVERSE INTERIOR DOORS



MENTON 1, WALNUT CLASSIC CPL facing layer, handle: TOPAZ, stainless steel



MENTON 1



MENTON 2



MENTON 3



MENTON 4



MENTON 5



MENTON 6



MENTON 7



MENTON 8



MENTON 9



MENTON 10



MENTON 11



MENTON 12

## DESIGN

- rebated, non-rebated or reverse door leaf
- MDF stiles and rails covered with two HDF boards in GREKO facing layers
- internal timber stiles and top rail, MDF bottom rail, covered with two HDF boards in CPL and PREMIUM facing layer
- rigid honeycomb infill or solid core infill for additional charge
- optional door frame extension panels and a crossheads with pilasters are available for surcharge, pp. 139-141
- the door can be trimmed by a customer, go to p. 137 for details

## FINISH

- door leaf edge made in the STANDARD technology.
- CPL 0.2 & 0.7 laminates available only with the STANDARD edge with the ABS edging in the same colour as the door leaf only or, against an additional charge, with a standard black edge
- edge (in standard or non-rebated finish) faced with an edging in the same colour as the surface or, optionally, in plain black (black edging with transverse NATUR OAK PREMIUM, a black edge with a transverse structure)

## HARDWARE

- three pin mortise hinges in a rebated door leaf
- three concealed hinges in the non-rebated leaf and two hinges in the reverse leaf (third for an extra charge) in silver (black or gold for an extra charge); hinges are supplied and priced with the door frame
- a lever tumbler lock in the rebated door leaf and a magnetic lock (lever tumbler lock as an option) in the non-rebated door leaf, optionally: key-locked, thumb turn cylinder, economy or with a silver blockade; or optionally, for an extra charge, a black or golden magnetic lock
- a magnetic lock in the reversed-swing door, optionally: key-locked, thumb turn cylinder, economy or with a silver blockade; or optionally, for an extra charge, a black or golden magnetic lock

## GLAZING

- **tempered frosted Decormat glass as standard**, clear or, for an extra charge, frosted VSG 221 safety glass, plain on both sides
- possibility to change the glazing side to REVERSE (standard glazing for OBVERSE)

## EXTRA CHARGES

### reverse door leaf

(not available in CPL 0.2 & 0.7)

solid core filling

door closer reinforcement

arm door closer (silver, black, white, brown)

additional bottom rail (can be trimmed by a customer up to max 8 cm)

enhanced airflow trim, ventilation undercut standard or mini (p. 137) or ventilation grille

metal round or square ventilation sleeves (4 pcs);

brushed nickel or patina finish in white or black

plastic sleeves

"100" rebated and non-rebated door leaf

frosted VSG 221 laminated glass

drop down seal <sup>2)</sup>

metal hinge casings in the rebated door leaf (brushed nickel, patina, polished chrome, polished brass, white and black)

black door leaf edge finish

can be replaced with a black or golden magnetic lock for non-rebated and reverse leaves

can be changed to hinges and strike plate in black or gold for non-rebated door leaves

magnetic stop (buffer) <sup>2)</sup>

(available in six colours p. 137)

PL2112 standard

+ 15% on the door price before surcharges

## GREKO



## CPL



## PREMIUM

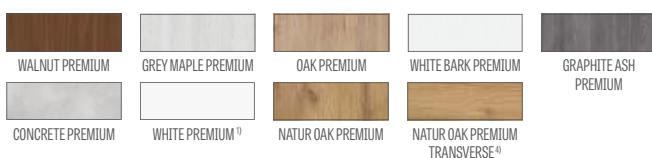

## AVAILABLE DOOR LEAF WIDTHS



## AVAILABLE SOLUTIONS (pp. 142-153)

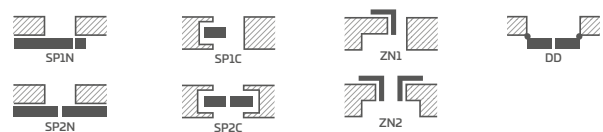

## EDGE FINISH TYPES

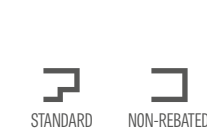

## GLASS FRAME



BLACK PLAIN DOOR LEAF EDGE FINISH



BLACK HORIZONTAL DOOR LEAF EDGE FINISH

<sup>1)</sup> plain white facing imitating a painted surface

<sup>2)</sup> a stop will not allow a drop down seal and an enhanced airflow trim to be used, and vice versa

<sup>3)</sup> special **AntiFinger** coating to reduce dirt and fingerprints

<sup>4)</sup> comes complete with the NATUR OAK PREMIUM door frame

<sup>5)</sup> only for non-rebated and reversed swing doors

<sup>6)</sup> until stock lasts

# SORANO

REBATED, NON-REBATED AND REVERSE INTERIOR DOORS



SORANO 1, WENGE DARK ST CPL facing layer, handle: TOPAZ stainless steel handle



SORANO 1



SORANO 2



SORANO 3



SORANO 4



SORANO 5



SORANO 6



SORANO 7



SORANO 8



SORANO 9



SORANO 10



SORANO 11



SORANO 12

## DESIGN

- rebated, non-rebated or reverse door leaf
- MDF stiles and rails covered with two HDF boards in GREKO facing layers
- internal timber stiles and top rail, MDF bottom rail, covered with two HDF boards in CPL and PREMIUM facing layer
- rigid honeycomb infill or solid core infill for additional charge
- optional door frame extension panels and a crossheads with pilasters are available for surcharge, pp. 139-141
- the door can be trimmed by a customer, go to p. 137 for details

## FINISH

- door leaf edge made in the STANDARD technology.
- CPL 0.2 & 0.7 laminates available only with the STANDARD edge with the ABS edging in the same colour as the door leaf only or, against an additional charge, with a standard black edge
- edge (in standard or non-rebated finish) faced with an edging in the same colour as the surface or, optionally, in plain black (black edging with transverse NATUR OAK PREMIUM, a black edge with a transverse structure)

## HARDWARE

- three pin mortise hinges in a rebated door leaf
- three concealed hinges in the non-rebated leaf and two hinges in the reverse leaf (third for an extra charge) in silver (black or gold for an extra charge); hinges are supplied and priced with the door frame
- a lever tumbler lock in the rebated door leaf and a magnetic lock (lever tumbler lock as an option) in the non-rebated door leaf, optionally: key-locked, thumb turn cylinder, economy or with a silver blockade; or optionally, for an extra charge, a black or golden magnetic lock
- a magnetic lock in the reversed-swing door, optionally: key-locked, thumb turn cylinder, economy or with a silver blockade; or optionally, for an extra charge, a black or golden magnetic lock

## GLAZING

- **tempered frosted Decormat glass as standard**, clear or, for an extra charge, frosted VSG 221 safety glass, plain on both sides
- possibility to change the glazing side to REVERSE (standard glazing for OBVERSE)

## EXTRA CHARGES

### reverse door leaf

(not available in CPL 0.2 & 0.7)

solid core filling

door closer reinforcement

arm door closer (silver, black, white, brown)

additional bottom rail (can be trimmed by a customer up to max 8 cm )

enhanced airflow trim, ventilation undercut standard or mini (p. 137) or ventilation grille

metal round or square ventilation sleeves (4 pcs);

brushed nickel or patina finish in white or black

plastic sleeves

"100" rebated and non-rebated door leaf

frosted VSG 221 laminated glass

drop down seal <sup>2)</sup>

metal hinge casings in the rebated door leaf (brushed nickel, patina, polished chrome, polished brass, white and black)

black door leaf edge finish

can be replaced with a black or golden magnetic lock for non-rebated and reverse leaves

can be changed to hinges and strike plate in black or gold for non-rebated door leaves

magnetic stop (buffer) <sup>2)</sup>

(available in six colours p. 137)

PL2112 standard

+ 15% on the door price before surcharges

## GREKO



## CPL



## PREMIUM

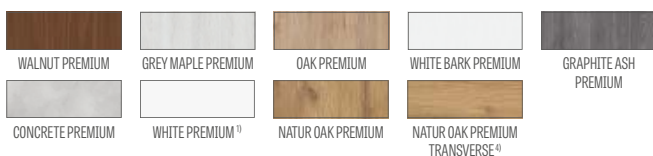

## AVAILABLE DOOR LEAF WIDTHS



## AVAILABLE SOLUTIONS (pp. 142-153)

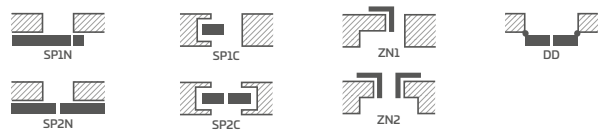

## EDGE FINISH TYPES

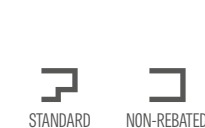

## GLASS FRAME



BLACK PLAIN DOOR LEAF EDGE FINISH



BLACK HORIZONTAL DOOR LEAF EDGE FINISH

<sup>1)</sup> plain white facing imitating a painted surface

<sup>2)</sup> a stop will not allow a drop down seal and an enhanced airflow trim to be used, and vice versa

<sup>3)</sup> special **AntiFinger** coating to reduce dirt and fingerprints

<sup>4)</sup> comes complete with the NATUR OAK PREMIUM door frame

<sup>5)</sup> only for non-rebated and reversed swing doors

<sup>6)</sup> until stock lasts



# FORTECA RC2 & RC3

OPENING INWARDS/OUTWARDS RC2 & RC3 BURGLARPROOF REBATED DOORS



FORTECA RC3 facing layer, LIGHT GRAY ST CPL, LUX 220 inlay



2 HOOK BOLTS



UPPER AND LOWER SECURITY LOCKS



FOUR ADJUSTABLE DOOR STRIKE PLATES

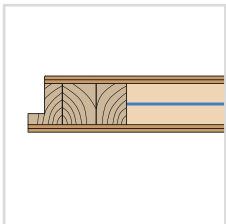

DOOR LEAF 46 mm reinforced with steel sheet

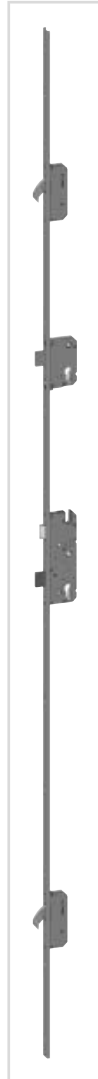

MULTIPOINT LOCK



FOUR 2-PIN HINGES; Ø16, 3D ADJUSTABLE



4 HINGE BOLTS



FIXED DOOR FRAME  
Timber frame in RC2; Reinforced frame in RC3



HARDWOOD THRESHOLD (clear lacquer)



FORTECA RC2



FORTECA RC3



MAGNETIC STOP, silver

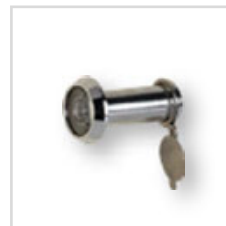

DOOR VIEWER



STAINLESS STEEL THRESHOLD

### FORTECA DOOR LEAF CROSS-SECTION

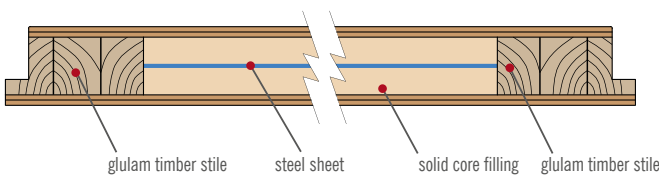

HARDWOOD THRESHOLD

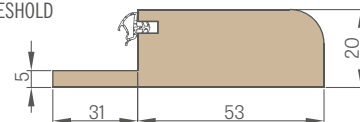

STAINLESS STEEL SHEET THRESHOLD

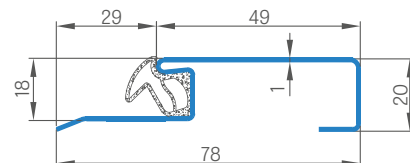

# FORTECA RC2 & RC3

OPENING INWARDS/OUTWARDS RC2 & RC3 BURGLARPROOF REBATED DOORS



FORTECA RC2 & RC3 with OAK ST CPL facing



FORTECA RC2, NATUR OAK PREMIUM facing layer, anti-burglar RC2 handle, black matt

FORTECA RC 2		
GOLD PACKAGE	SILVER PACKAGE	DOOR LEAF <sup>1)</sup>

FORTECA RC 3		
GOLD PACKAGE	SILVER PACKAGE	DOOR LEAF <sup>1)</sup>

**RC2 – Important:**

For compliance with RC2 burglary resistance class as per the PN-EN 1627:2012, the hardware should meet the following requirements:

- Min Class 2 as per PN-EN 1906:2012 – for handles and door escutcheons
- Min Class 4 and 1 as per PN-EN 1303:2015 – for lock cylinders

**RC3 – Important:**

For compliance with RC3 burglary resistance class as per PN-EN 1627:2012, the hardware should meet the following requirements:

- Min Class 3 as per PN-EN 1906:2012 – for handles and door escutcheons
- Min Class 4 and 1 as per PN-EN 1303:2015 – for lock cylinders

<sup>1)</sup> only used in combination for steel door frames p. 111

## GENERAL INFORMATION

- the FORTECA inwards/outwards opening burglar-proof doors are rated for sound insulation at  $R_w=38$  dB, have a burglary resistance class of RC2 OR RC3 as per PN EN 1627:2012 and class 5 for mechanical durability.
- available in the GOLD and SILVER packages with optional installation kit and steel door frame.
- designed to be used as an internal front door.

## DESIGN

- timber stile covered with glulam HDF boards
- specially designed solid core filling
- whole door leaf reinforced with a steel panel
- door leaf thickness of 46 mm

## FINISH

- leaf edge made in the STANDARD technology (with CPL 0.2 & 0.7 laminates, with the ABS edging in the same colour as the leaf only or with a standard black edge against an additional charge)
- Insert (inlay) colour: brushed steel, black, brushed gold and CLASSIC OAK CPI with a width of 8 mm or 50 mm flush with the door leaf plane, made on both sides of the leaf, pp. 86-91
- the edge veneered in the same colour as the door leaf or, optionally plain black (transverse NATUR OAK PREMIUM, black edge with a transverse structure)
- HDF board faced with the GREKO, PREMIUM, CPL
- side and top panels glued to the wall (only for the door frame mounted on masonry and 8 cm clip-on square) – p. 140, and panels integrated with door frame – p. 141

## HARDWARE

- four silver 2-pin hinges;  $\varnothing 16$ ; 3D adjustable (2D with steel frame)
- four-point security hook bolt lock as standard for two lock cores
- four-hinge bolts on the hinge side
- possibility to apply an arm door closer
- lower lock PZ centre is 92 mm

## FIXED REBATED DOOR FRAME

- fixed timber door frame covered with MDF boards; Internally reinforced with a steel square on the door striker plates side for FORTECA RC3
- installation in the range of 90-450 mm every 40 mm
- adjustable main grip in the door frame and two adjustable grips for the bolt hook and additional lock

## GOLD PACKAGE / GOLD black

- the GOLD PACKAGE FORTRESS doors are complete with a steel or timber threshold, with a multipoint lock, and pre-drilled holes for a security handle and upper face plate. They come with with a door viewer (opening by customer) and approved burglar-proof handles and cylinders in silver or, at an extra charge, black in the GOLD package with black finishing.

## SILVER PACKAGE

- the SILVER PACKAGE FORTRESS doors are complete with a steel or timber threshold, and a multipoint lock. We recommend ordering a door viewer and certified hardware from the ERKADO range or ordering the same from an external supplier keeping in mind the important note on compliance with the anti-burglary requirements (p. 108).

## AVAILABLE DOOR LEAF WIDTHS

80N 80 90E 100

- GOLD PACKAGE / GOLD black**  
door leaf with a fixed timber frame, stainless steel threshold and silver hardware or black hardware in GOLD package with black finish for extra charge
- SILVER PACKAGE**  
door leaf with fixed timber frame, stainless steel threshold, w/o hardware

## EXTRA CHARGE

surcharge for GOLD package in black finish

- RC 2

- RC 3

"100" door

black door leaf edge finish

handle PZ centre of 92 mm with the upper escutcheon for RC 2 doors, silver F9 or black (Class 2 as per the PN-EN 1906:2012 standard)

handle with lock core protection and upper escutcheon for the RC3 door; F9 silver (Class 3 as per PN-EN 1906:2012)

two lock cores set (one with a thumbturn) in a master key system for RC2 and RC3 doors (Class 4 & 1 as per PN-EN 1303:2015)

door viewer

- nickel

- black

metal hinge casings: brushed nickel, patina, polished chrome, polished brass, white and black

cutting the door with the wooden frame by up to 8 cm and with steel frame by up to 6 cm in 1 cm increments

LUX inlay; available versions p. 86-91

arm door closer (silver, black, white, brown)

magnetic stop (buffer)

(available in six colours p. 137)

## GREKO



## CPL



## PREMIUM

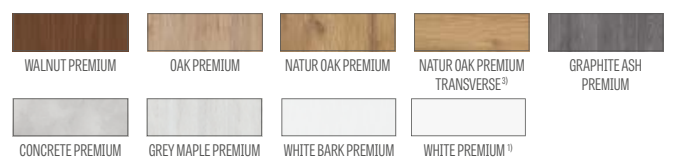

<sup>1)</sup> plain white facing imitating a painted surface

<sup>2)</sup> special **AntiFinger** coating to reduce dirt and fingerprints

<sup>3)</sup> comes complete with the NATUR OAK PREMIUM door frame

<sup>4)</sup> until stock lasts

# FIXED DOOR FRAME

FORTECA

## FORTECA RC3 FIXED DOOR FRAME

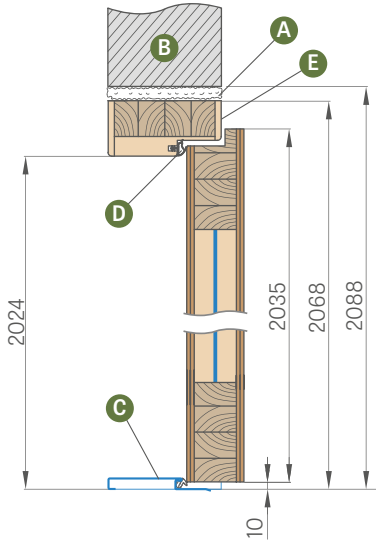

**MASONRY WALL every 40 mm**  
(the clip-on square not included, charged extra)

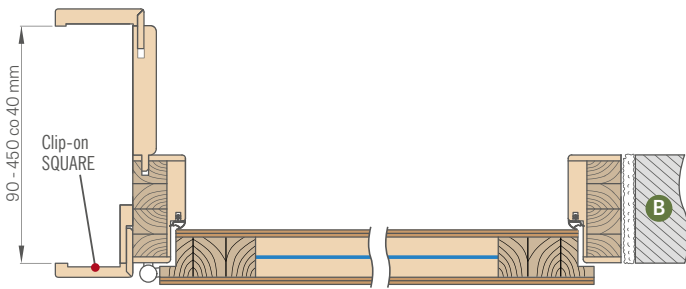

Range (mm)
90-130
130-170
170-210
210-250
250-290
290-330
330-370
370-410
410-450

The wall cladding is available with a 6 cm or 8 cm internal angle and with a choice of 6 cm or 8 cm external angle against an extra charge. We only use the cladding for GOLD and SILVER packages.

### EXTRA CHARGES

frame joints at 90 degrees

clip-on square with 60 mm or 80 mm clips (the clip-on square with three clips extends the adjustment range by 20 mm)

cutting the door with the wooden frame to 8 cm in 1 cm increments

side and top panels available as glued to the wall and panels integrated with the frame (only for frames with cladding and 8 cm square)

headband and quarter round

- A - installation foam
- B - wall
- C - stainless steel or wooden threshold
- D - rubber gasket
- E - additional internal reinforcement in the frame with a steel square on the door striker plates side (only for the Fortress RC3 door frame)

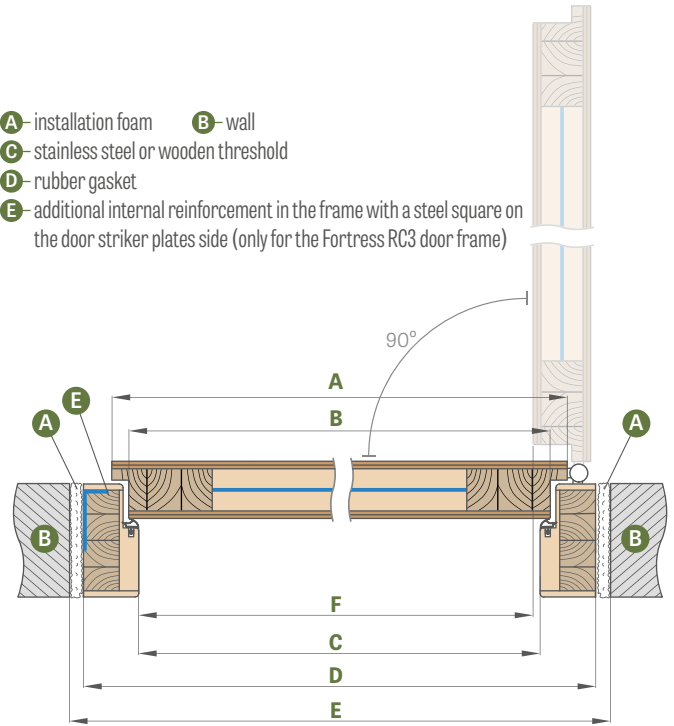

Door width	A	B	C	D	E	F
"80N"	804	778	764	852	892	759
"80"	848	822	808	896	936	803
"90E"	948	922	908	996	1036	903
"100"	1048	1022	1008	1096	1136	1003

"90E" - installation width

### FIXED DOOR FRAME

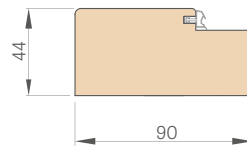

### COVER PROFILE

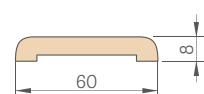

### Clip-on SQUARE 6 cm and 8 cm with clips

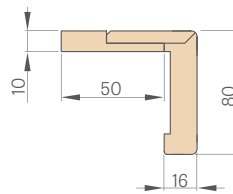

### QUARTER ROUND

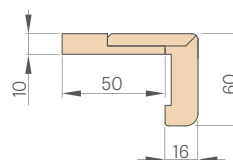
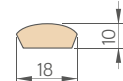

# STEEL DOOR FRAMES

FORTECA

## ADJUSTABLE STEEL DOOR FRAME (OVERLAPPING)

Welded and coated in RAL 9003, 9010, 9016, 8003, 8017, 7016, 7022, 9005, 7047, 1001

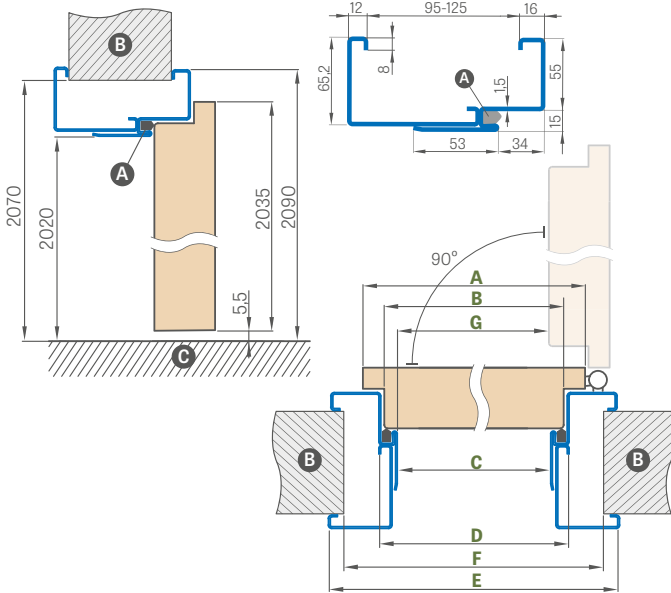

Door width	A	B	C	D	E	F	G
"80N"	804	778	761	791	901	865	754.5
"80"	848	822	805	835	945	910	798.5
"90ES"	960	934	917	947	1057	1022	910
"100" <sup>1)</sup>	1048	1022	1005	1035	1145	1110	998.5

"90ES" – installation width for a steel door frame

## LARGE SQUARE STEEL FRAME

Welded and coated in RAL 9003, 9010, 9016, 8003, 8017, 7016, 7022, 9005, 7047, 1001

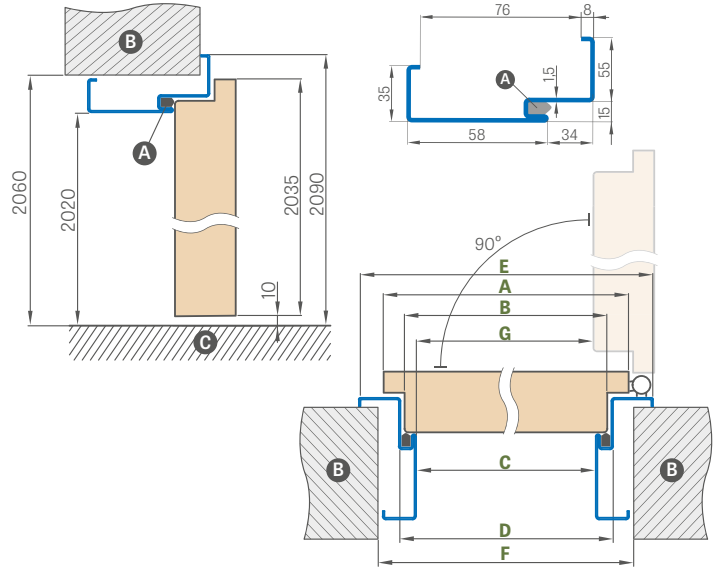

Door width	A	B	C	D	E	F	G
"80N"	804	778	761	791	901	840	754.5
"80"	848	822	805	835	945	885	798.5
"90ES"	960	934	917	947	1057	997	910
"100" <sup>1)</sup>	1048	1022	1005	1035	1145	1085	998.5

### FORTECA RC2 ADJUSTABLE STEEL DOOR FRAME

Adjustment Range min-max (mm)
95-125
125-155
155-185
185-215
215-245
245-275
275-305
305-335
335-365

### FORTECA RC3 ADJUSTABLE STEEL DOOR FRAME

Adjustment Range min-max (mm)
95-125
125-155
155-185
185-215
215-245
245-275
275-305
305-335
335-365

### FITTING THE SQUARE FRAME

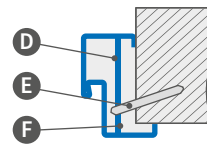

- A** – gasket
- B** – wall
- C** – floor
- D** – mounting anchor
- E** – wall plug
- F** – to be filled

### EXTRA CHARGES

"100" Square frame, large version

door closer reinforcement

stainless steel threshold

cutting the door with the steel frame to 6 cm in 1 cm increments

galvanised sheet steel

non-typical RAL (rare, intensive, pearly and metallic colours not included)

### RAL



RAL 9003<sup>1)</sup> RAL 9010 RAL 9016 RAL 8003 RAL 8017 RAL 7016 RAL 7022<sup>1)</sup> RAL 9005<sup>1)</sup> RAL 7047 RAL 1001

<sup>1)</sup> additional charge +10%

# HERSE SET and MAX SET EKO 30dB

HERSE SET and MAX SET 32 dB HERSE SET and MAX SET AKUSTIC 39 dB

FRONT DOORS WITH BURGLAR-PROOF LOCKS OR STRIP LOCKS



HERSE SET with WALNUT CLASSIC CPL facing layer with ESSEN handle

## GENERAL INFORMATION

- HERSE SET and MAX SET doors are designed for housing and public utility building as an entrance internal door (excluding the "80N" width).
- the HERSE SET and MAX SET door leaf with fixed and adjustable door frame with each of thresholds available is rated for sound insulation at  $R_w = 30\text{dB}$  or, for surcharge,  $R_w = 32\text{dB}$  and  $R_w = 39\text{dB}$ .
- HERSE SET and MAX SET doors in GOLD and SILVER Packages are fully preassembled with a threshold fitted, and pre-drilled holes for handle and upper escutcheon installation for the GOLD version.
- HERSE MAX SET doors are only available in PREMIUM facing layers: WALNUT, GREY MAPLE, OAK, WHITE BARK, GRAPHITE ASH, CONCRETE, NATUR OAK, TRANSVERSE NATUR OAK

## DESIGN

- timber frame for  $R_w = 32\text{dB}$  and  $R_w = 39\text{dB}$  or MDF for  $R_w = 30\text{dB}$  covered with two HDF boards
- specially designed solid core filling
- robust steel channel section reinforcement  $R_w = 30\text{dB}$  and  $R_w = 32\text{dB}$  and additionally steel plate reinforcement for  $R_w = 39\text{dB}$
- door leaf thickness of 46 mm
- additional seal in the door leaf only for  $R_w = 32\text{dB}$  and  $R_w = 39\text{dB}$

## FINISH

- door leaf edge made in the STANDARD technology
- CPL 0.2 & 0.7 laminates available with the STANDARD edge with the ABS edging in the same colour as the door leaf only or, against an additional charge, with a standard black edge (not available for HERSE MAX SET)
- insert (inlay) colour: brushed steel, black, brushed gold, brushed copper and OAK CLASSIC CPL with a width of 8 mm or 50 mm flush with the door leaf plane, made on both sides of the leaf, pp. 86-91 (not available for HERSE MAX SET)
- STANDARD edge faced with an the same colour as the door leaf or, optionally, plain black edging (transverse NATUR OAK PREMIUM, black edge with a transverse structure)
- factory cut by up to 8 cm for an additional charge
- custom order with the lower lock only as an option
- side and top panels glued to the wall (only for the adjustable door frame with an 8 cm square) – p. 140, and panels integrated with door frame – p. 141

## HARDWARE

- three silver 2-pin hinges;  $\varnothing 16$ ; 3D adjustable (2D with a steel frame)
- two 3-pin Class 2 rated security locks with a thumb turn (optionally only lower)
- three hinge bolts on the hinge side
- possibility to apply an arm door closer
- lower lock PZ centre is 72 mm
- optional bolt strip lock for two lock cores available for an extra charge

## REBATED FIXED AND ADJUSTABLE DOOR FRAMES

- fixed door frame, wooden, for  $R_w = 32\text{dB}$  and  $R_w = 39\text{dB}$  or MDF for  $R_w = 30\text{dB}$
- optionally, an electric door strike can be used in the door frame for the lower lock with no upper lock in the door leaf.
- adjustable main keeper in frames
- the 80N width is available for the fixed door frame only
- in GOLD and SILVER packages for PREMIUM and CPL facing layers the colour of the frame can be changed to BLACK ST CPL

HERSE SET EKO 30 dB		
GOLD PACKAGE	SILVER PACKAGE	DOOR LEAF

HERSE MAX SET EKO 30dB		
GOLD PACKAGE	SILVER PACKAGE	DOOR LEAF

## ADDITIONAL CHARGE FOR DOOR

### HERSE SET 32 dB

(added to GOLD and SILVER packages or leaf)

### HERSE SET AKUSTIC 39 dB

(added to the GOLD and SILVER packages or leaves)

## GOLD PACKAGE

Leaf with fixed frame, stainless steel threshold and fittings<sup>5) 6)</sup>

## SILVER PACKAGE

Leaf with fixed frame, stainless steel threshold, without fittings<sup>5) 6)</sup>

## AVAILABLE DOOR LEAF WIDTHS

80N 80 90E 100

## EXTRA CHARGES

GOLD package in black finish

door viewer; silver  
door viewer; black

hardwood threshold (clear lacquer) for adjustable frames 55 mm wide or stainless steel threshold with gasket

hardwood threshold (clear lacquer) for adjustable frames

arm door closer (silver; black, white, brown)

door closer reinforcement

drop down seal <sup>2)</sup>

cutting the door leaf with a wooden frame by up to 8 cm and with a steel frame by up to 6 cm in 1 cm increments in the CZ standard

black door leaf edge finish

"100" Door leaf or package

30/45 lock core

- silver  
- black

30G/45 or 30/45G cylinder-holder; silver  
30G/45 or 30/45G cylinder-holder; black

30/45 lock core and 30G/45 or 30/45G cylinder-holder in the master key system

- silver  
- black

metal hinge casings: brushed nickel, patina, polished chrome, polished brass, white and black

ESSEN handle (nickel, satin, patina, black) <sup>6)</sup>

ESSEN upper escutcheon (nickel, satin, patina, black) <sup>6)</sup>

LUX inlay; available versions p. 86-91

additional charge for HERSE SET AKUSTIC 39 dB door  
(added to the GOLD and SILVER packages or leaves)

additional charge for HERSE SET 32 dB door  
(added to the GOLD and SILVER packages or leaves)

clip-on square, 3 pcs (extends the adjustment range by 20 mm)

magnetic stop (buffer) <sup>2)</sup>  
(available in six colours p. 137)

multi-point bolt strip lock with two locks <sup>7)</sup>

## EDGE FINISH TYPES



## MOULDING

(applies to HERSE MAX SET)

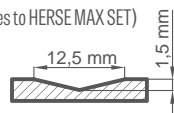

## GREKO

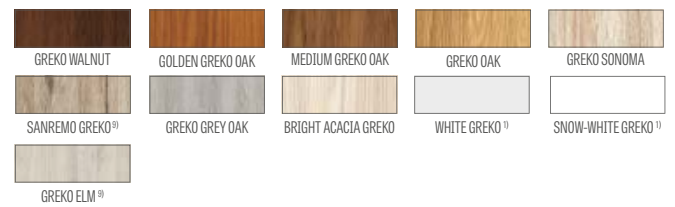

## CPL



## PREMIUM

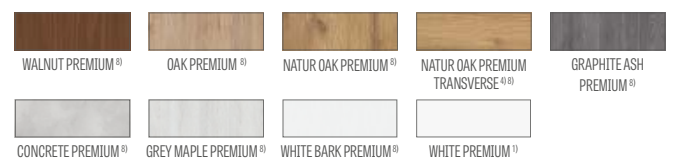

## HERSE MAX SET



HERSE MAX SET 23



HERSE MAX SET 26



HERSE MAX SET 30



HERSE MAX SET 31

<sup>1)</sup> plain white facing imitating a painted surface

<sup>2)</sup> a stop will not allow a drop down seal and an enhanced airflow trim to be used, and vice versa

<sup>3)</sup> special **AntiFinger** coating to reduce dirt and fingerprints

<sup>4)</sup> comes complete with the NATUR OAK PREMIUM door frame

<sup>5)</sup> hardware components: ESSEN handle in nickel satin, upper escutcheon, master key system lock

cores (top with a thumbturn), door viewer (no pre-drilled hole) in silver or; at an extra charge, black

<sup>6)</sup> ESSEN handles and escutcheons cannot be used with a multipoint lock

<sup>7)</sup> when using a multi-point bolt strip lock, it is not possible to install the ESSEN handle

<sup>8)</sup> facing layers featuring HERSE MAX SET

<sup>9)</sup> until stock lasts

# FIXED AND ADJUSTABLE FRAMES

HERSE SET, HERSE MAX SET

## HERSE SET FIXED DOOR FRAME

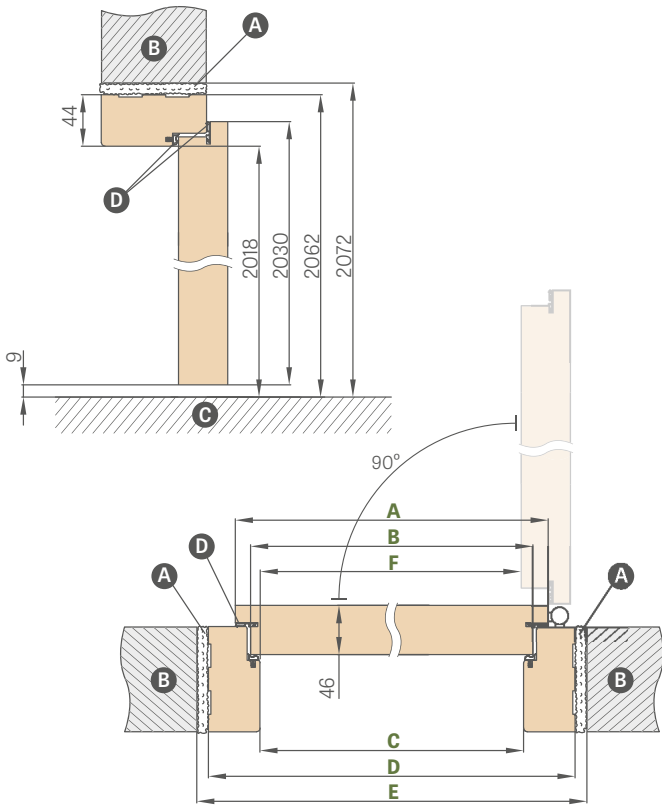

## HERSE SET ADJUSTABLE DOOR FRAME

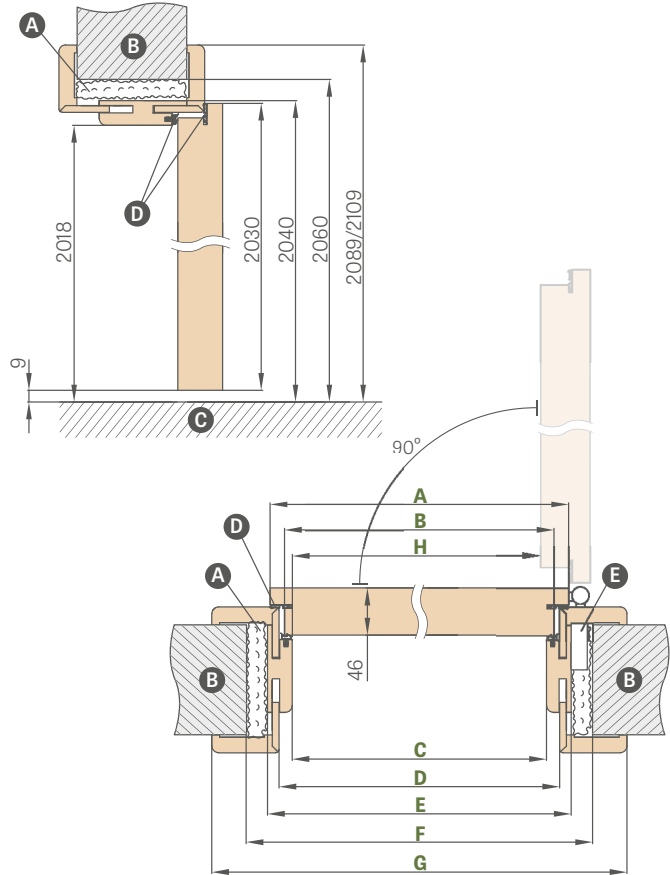

Door width	A	B	C	D	E	F
"80N"	804	777	764	852	872	756
"80"	844	817	804	892	912	796
"90E"	948	921	908	996	1016	900
"100"	1044	1017	1004	1092	1112	996

"90E" - installation width

Door width	A	B	C	D	E	F	G	H
"80"	844	817	804	826	848	888	946*/986**	796
"90E"	948	921	908	930	952	992	1050*/1090**	900
"100"	1044	1017	1004	1026	1048	1088	1146*/1186**	996

\* architrave 6 cm / \*\* architrave 8 cm

- A - installation foam ● B - wall ● C - floor ● E - catch socket
- D - gasket (for  $R_w = 30\text{dB}$  in door frame only, for  $R_w = 32\text{dB}$  and  $R_w = 39\text{dB}$  both in frame and door)

### ADJUSTABLE DOOR FRAME RANGE

architrave 6 cm / architrave 8 cm

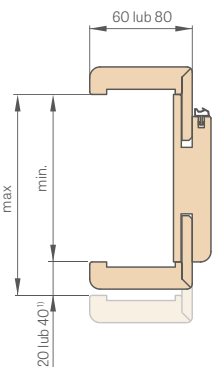

### ADJUSTABLE TIMBER THRESHOLD

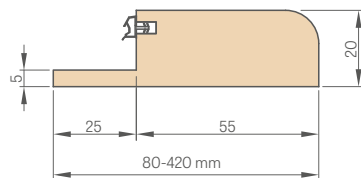

### SQUARE: 6 cm and 8 cm

Clip-on

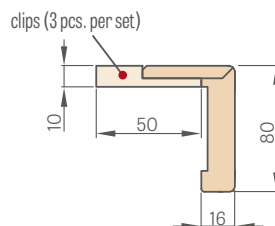

### FIXED DOOR FRAME

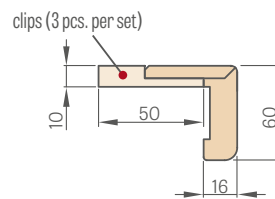
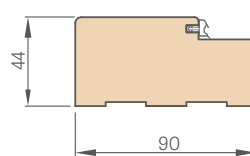

### COVER PROFILE

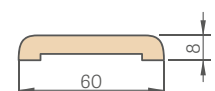

### QUARTER ROUND

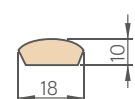

<sup>1)</sup> 40 mm for the 280-320 mm range

Adjustment Range min-max (mm)	
1 Component	80-100
	100-120
	120-140
	140-160
	160-180
	180-200
	200-220
	220-240
	240-260
	260-280
2 Components	280-300
	300-340
	340-360
	360-380
	380-400
	400-420

### FIXED HARDWOOD THRESHOLD, COLOURLESS LACQUER 55 mm



- the fixed frame, architrave and clip-on square in CPL 0.2 are also used in the set for door leaves in CPL 0.7
- joints at 90 degrees of the adjustable frame possible with the 8 cm architraves only. Additional charge for joining at 90 degrees
- electric door strike – at extra charge
- reinforcement for door closer on adjustable frame – at extra charge
- square with three clips (square with clips extends the adjustment range by 20 mm) - at an extra charge
- the architraves and quarter round – p. 169
- side and top panels glued to the wall available (only with an adjustable door frame and an 8 cm architrave) - at an extra charge
- cutting the door (leaf and frame) by up to 8 cm every 1 cm or the product as per the CZ standard - at an extra charge
- the hardwood door frame and threshold can be made up to the range of 500-520 mm – surcharge applies for every 2 cm, starting from the range of 400-420 mm
- changing the range by +20 mm (available in the ranges from 100-120 mm to 280-300 mm) - at an extra charge

# STEEL DOOR FRAMES

HERSE SET, HERSE MAX SET

## HERSE SET ADJUSTABLE STEEL DOOR FRAME (OVERLAPPING)

Welded and coated in RAL 9003, 9010, 9016, 8003, 8017, 7016, 7022, 9005, 7047, 1001

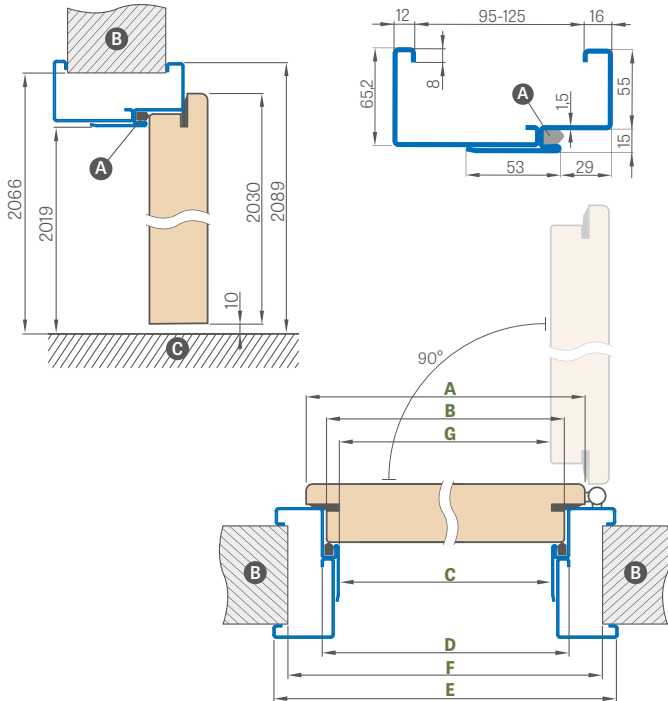

Door width	A	B	C	D	E	F	G
"80N"	804	777	761	791	901	855	756
"80"	844	817	801	831	941	895	796
"90ES"	948	921	905	935	1045	999	900
"100"	1044	1017	1001	1031	1141	1095	996

"90ES" - installation width for a steel door frame

Adjustment range min-max (mm)
95-125
125-155
155-185
185-215
215-245
245-275
275-305

## HERSE SET ADJUSTABLE SQUARE STEEL DOOR FRAME

Welded and coated in RAL 9003, 9010, 9016, 8003, 8017, 7016, 7022, 9005, 7047, 1001

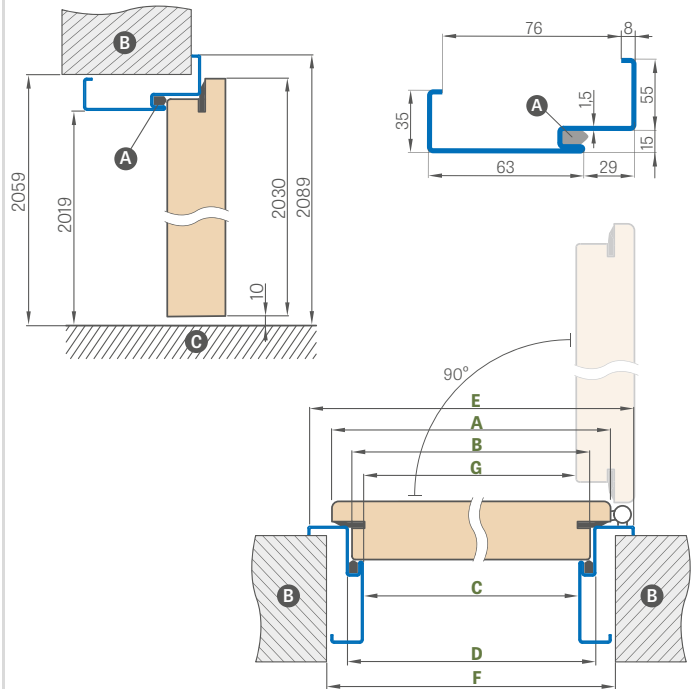

Door width	A	B	C	D	E	F	G
"80N"	804	777	761	791	901	841	756
"80"	844	817	801	831	941	881	796
"90ES"	948	921	905	935	1045	985	900
"100"	1044	1017	1001	1031	1141	1081	996

## FITTING THE SQUARE FRAME

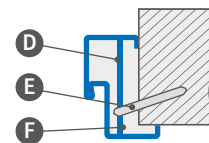

- A - gasket
- B - Wall
- C - floor
- D - mounting anchor
- E - anchor bolt
- F - To be filled

## EXTRA CHARGES

"100" Square frame, large version

electric door strike

door closer reinforcement

cutting the door with the steel frame by up to 6 cm in 1 cm increments

stainless steel threshold

galvanised sheet steel +10%

non-typical RAL (rare, intensive, pearly and metallic colours not included) +10%

## RAL



<sup>1)</sup> additional charge +10%

# UNITED STEEL DOOR FRAME

HERSE SET, HERSE MAX SET

## UNITED STEEL DOOR FRAME DIAGRAM

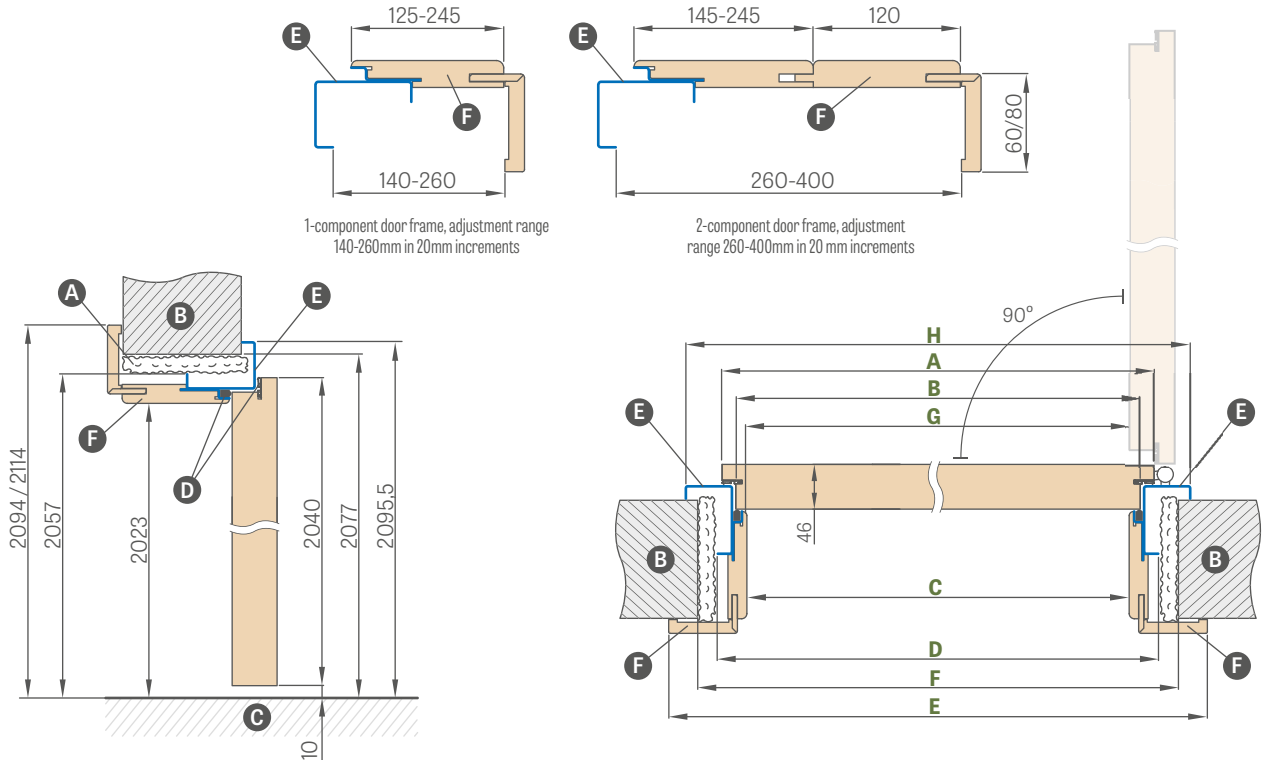

Door width	A	B	C	D	E	F	G	H
"80U"	844	817	791.5	859	933.5 / 973.5	899	790	935
"90EU"	960	933	907.5	975	1049.5 / 1089.5	1015	906	1051
"100U"	1044	1017	991.5	1059	1133.5 / 1173.5	1099	990	1135

"90EU" - installation width for the UNITED steel door frame

- A** - installation foam
- B** - wall
- C** - floor
- D** - rubber gasket
- E** - steel part painted in RAL colour
- F** - MDF part with laminate/foil

Adjustment Range min-max (mm)	
1 component	140-160
	160-180
	180-200
	200-220
	220-240
	240-260
2 Components	260-280
	280-300
	300-320
	320-340
	340-360
	360-380
	380-400

### EXTRA CHARGES

- electric door strike
- door closer reinforcement
- cutting the door with a UNITED steel door frame by up to 6 cm in 1 cm increments
- stainless steel threshold, height: 20 mm
- galvanised sheet steel
- non-typical RAL (rare, intensive, pearly and metallic colours not included)

### RAL



<sup>1)</sup> additional charge +10%

# LEDA EI30, EI60

FIRE INTERNAL FRONT DOORS MADE IN HALSPAN TECHNOLOGY

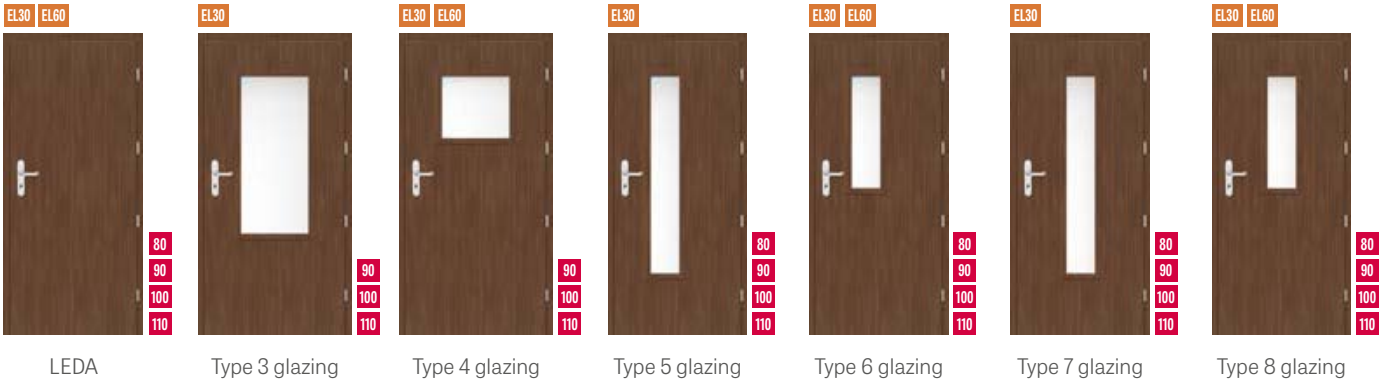

## ADJUSTABLE STEEL DOOR FRAME (OVERLAPPING)

Adjustment Range min-max (mm)	LEDA EI30 door frame + adjustable steel door frame			LEDA EI60 door frame + adjustable steel door frame		
	"80"	"90ES"	"100"	"80"	"90ES"	"100"
95-125						
125-155						
155-185						
185-215						
215-245						
245-275						
275-305						

"90ES" - installation width for a steel door frame

## SQUARE STEEL DOOR FRAME, LARGE

LEDA EI30 door frame + large square steel door frame			LEDA EI60 door frame + large square steel door frame		
"80"	"90ES"	"100"	"80"	"90ES"	"100"

"90ES" - installation width for a steel door frame

## DOOR LEAF WITH FIXED TIMBER DOOR FRAME

LEDA EI30 Leaf + fixed timber door frame			LEDA EI60 Leaf + fixed timber door frame		
"80"	"90E"	"100"	"80"	"90E"	"100"

### GREKO

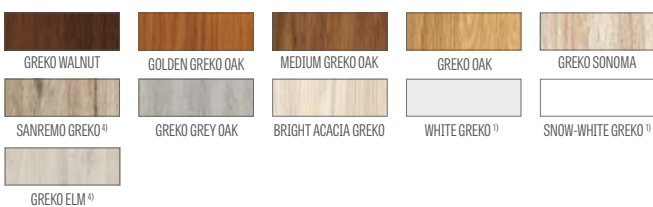

### PREMIUM

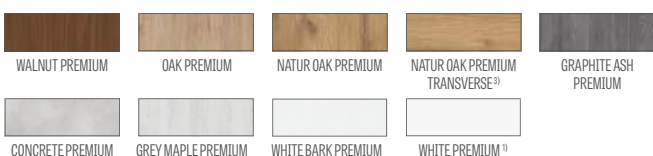

### CPL

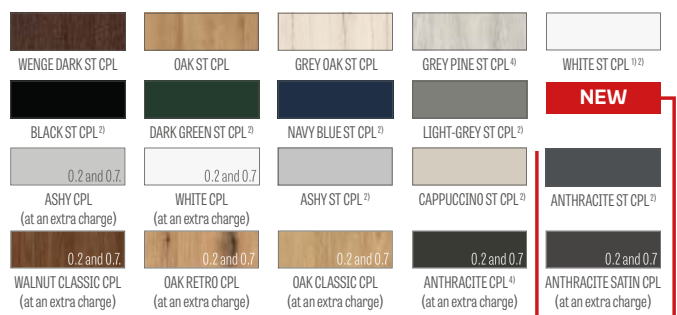

- 1) plain white facing imitating a painted surface
- 2) special **AntiFinger** coating to reduce dirt and fingerprints
- 3) comes complete with the NATUR OAK PREMIUM door frame
- 4) until stock lasts

## GENERAL INFORMATION

Fire protection, smoke control and sound insulation are ensured only when a complete doorset is installed, including a fire door leaf (with gaskets, lock, hinges and drop down seal pre-assembled), door frame, door closer, as well as a lock core and handle in compliance with the Polish Standard.

The sound insulation of the HALSPAN door system supplied with a drop-down gasket as per PN-B-02151-03:1999 is rated at  $R_w=32$  dB

The door leaves are marketed complete with a timber or steel door frame only.

## DESIGN

- filled with a special HALSPAN board with a thickness of 44 mm for Type EI30 and 54 mm for EI60
- overall door leaf thickness 50 mm in EI30 and 60 mm in EI60
- softwood door frame
- fire rated and smoke intumescent door gasket
- drop down seal
- transparent fire-resistant glass; the glass width is fixed (not dependent on) the door leaf width

## FINISH

- leaf edge made in the STANDARD technology (with CPL 0.2 & 0.7 laminates, with the ABS edging in the same colour as the leaf only or with a standard black edge against an additional charge)
- 8 mm or 50 mm wide brushed steel, brushed gold, black or CLASSIC OAK CPL inlays flush with the door leaf, on both leaf sides. Applies to LEDA full only. Inlay types shown on pages 86-91
- two-sided inlays only in full leaf and on only on the active leaf in double doors
- the edge veneered in the same colour as the door leaf or, optionally plain black (transverse NATUR OAK PREMIUM, black edge with a transverse structure)
- Side and top panels glued to the wall (only when fitted with an 8 cm square) – page 140

## HARDWARE

- four hinges;  $\varnothing 16$ ; 3D adjustable (2D for the steel frame)
- thumb turn cylinder lock
- door closer against an additional charge

## DOOR FRAMES

- fire rated fixed door frame
- fire rated gasket
- adjustable door striker plate
- adjustable steel, square large or welded frames in RAL 9003, 9010, 9016, 8003, 8017, 7016, 7022, 7047, 1001
- steel frame made of black sheet metal, 1.5 mm thick, RAL powder painted, welded in the corners, fitted with a door closer reinforcement as standard.

## EXTRA CHARGES

fire rated arm door closer in colours: silver, black, white, brown

fire rated cam-action door closer (only for frames with or without housing with a clip-on square) in colours: silver, black, white, brown

fire rated ventilation grille

JOWISZ INOX handle, backplate, euro profile, see p. 131

30/40 lock core (EI30) or 30/50 (EI60) (silver)

fire-proof door viewer, satin, chrome

metallic hinge casings (matt chrome, black)

fire rated lever tumbler lock, top mounting

black door leaf edge finish

Housing for EI30 from 100 to 460 and

Housing for EI60 from 120 to 480 every 40 mm

Double door housing

fire rated electric door strike

(standard) 12/24V (not for the steel door frame)

steel door frame in RAL not in the range (intensive, pearl and metallic colours not included)

steel door frame made of galvanised sheet steel

EI30

extra charge for type 3 glazing

extra charge for type 4 glazing

extra charge for type 5, 7 glazing

extra charge for type 6, 8 glazing

EI60

extra charge for type 4 glazing

extra charge for type 6, 8 glazing

LUX inlay; available versions p. 86-91

(on both sides only on the solid core door and on the active leaf in the double leaf)

CPL 0.2 laminate (for doors w/o housing)

CPL 0.7 laminate (for doors w/o housing)

clip-on square<sup>1)</sup>

(The clip-on square extends the adjustment range by 20 mm)

additional charge for the "110" leaf

side and top panels glued to the wall available (only with a wall installed door frame and an 8 cm square)

<sup>1)</sup> In the version with housing, the clip-on square is included

# LEDA EI30, EI60

## SINGLE DOOR

### FIXED WOODEN DOOR FRAME

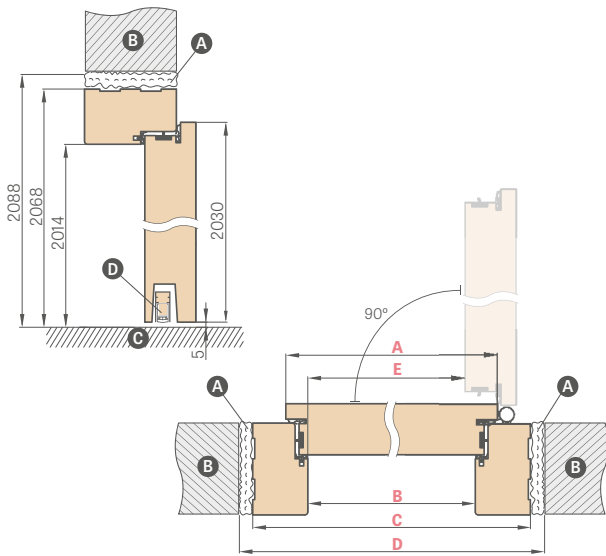

Door width	A	B	C	D	E
"80"	860	817	925	955	805
"90E"	960	917	1025	1055	905
"100"	1060	1017	1125	1155	1005
"110"	1160	1117	1225	1255	1105

- A** fire-resistant installation foam
- B** wall
- C** floor
- D** drop down seal

"90E" – installation width

### ADJUSTABLE STEEL FIRE DOOR FRAME (OVERLAPPING)

Welded and coated in RAL 9003, 9010, 9016, 8003, 8017, 7016, 7022, 7047, 1001

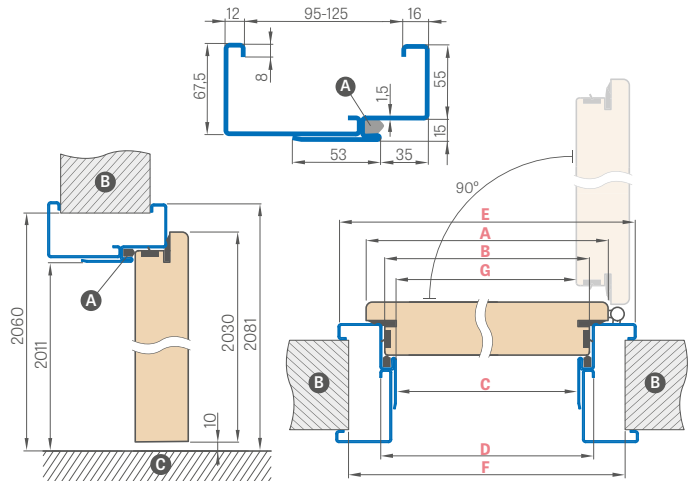

Door width	A	B	C	D	E	F	G
"80"	860	834	813	843	953	910	802
"90ES"	960	934	913	943	1053	1010	902
"100"	1060	1034	1013	1043	1153	1110	1002
"110"	1160	1134	1113	1143	1253	1210	1102

"90ES" – installation width for a steel door frame

### FIRE RATED DOOR FRAME CROSS-SECTION IN MASONRY AND WITH CLIP-ON SQUARE

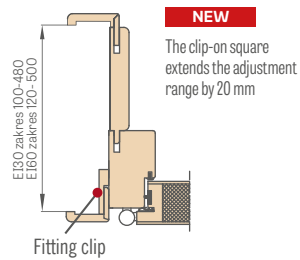

### FIRE RATED DOOR FRAME CROSS-SECTION IN BASIC MASONRY

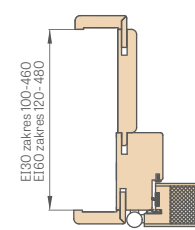

### SQUARE 6 cm and 8 cm with clips

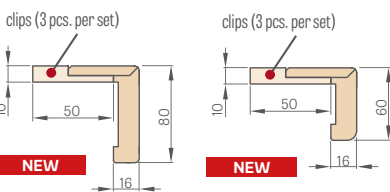

### FIRE RATED FIXED DOOR FRAME CROSS-SECTION

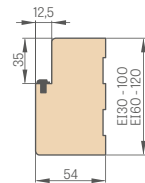

### LARGE STEEL FIRE SQUARE DOOR FRAME (OVERLAPPING)

Welded and coated in RAL 9003, 9010, 9016, 8003, 8017, 7016, 7022, 7047, 1001

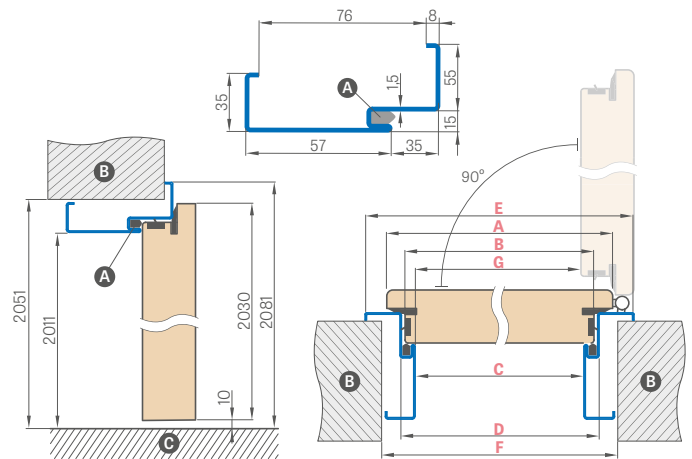

Door width	A	B	C	D	E	F	G
"80"	860	834	813	843	953	890	802
"90ES"	960	934	913	943	1053	990	902
"100"	1060	1034	1013	1043	1153	1090	1002
"110"	1160	1134	1113	1143	1253	1190	1102

### CAM-ACTION DOOR CLOSER <sup>1)</sup>



### ARM DOOR CLOSER



### RAL



<sup>1)</sup> use the cam action door closer for a fixed door frame only or for frames with a clip-on square  
120

<sup>2)</sup> additional charge +10%

# LEDA EI30, EI60

## DOUBLE DOORS

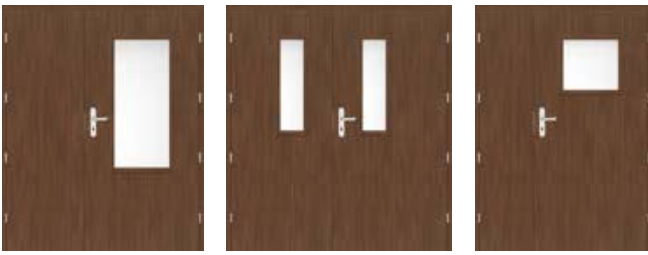

LEDA 3 "90E"  
+ passive "60" door leaf

LEDA 6 "90E"  
+ passive "80" door leaf

LEDA 4 "90E"  
+ "40" side panel

### LEDA EI30 & EI60 DOUBLE DOORS

- the double doors are made within the LEDA EI30 and EI60 ranges with prices depending on the colour and finish (STANDARD);
- the passive leaf is made in two versions:
  - solid core for widths: "60", "70", "80"
  - glazed in types 5, 6, 7, 8 for EI30 and glazed in types 6 and 8 for EI 60
- side panel for the widths of "30", "40" and "50", all of which are solid core, plain doors;
- the passive leaf and side panel are supplied with shootbolt locks and bolt keepers; w/o lippings.

### AVAILABLE ACTIVE DOOR LEAF WIDTHS FOR DIFFERENT FIRE DOOR TYPES

LEDA	LEDA Type 3 glazing	LEDA Type 4 glazing	LEDA Type 5 glazing
EL30 EL60 80 90E 100	EL30 90E 100	EL30 EL60 90E 100	EL30 80 90E 100
LEDA Type 6 glazing	LEDA Type 7 glazing	LEDA Type 8 glazing	
EL30 EL60 80 90E 100	EL30 80 90E 100	EL30 EL60 80 90E 100	

### AVAILABLE PASSIVE DOOR LEAF WIDTHS FOR DIFFERENT FIRE DOOR TYPES

LEDA	LEDA Type 5 glazing	LEDA Type 6 glazing
EL30 EL60 60 70 80	EL30 70 80	EL30 EL60 70 80
LEDA Type 7 glazing	LEDA Type 8 glazing	
EL30 70 80	EL30 EL60 70 80	

### DOUBLE DOOR PRICE

The price includes

- active part = price of full single door, plus possible extra charges as for single doors
- passive part = price for the solid version (also side panel), plus possible extra charges as for single doors

### AVAILABLE DOOR LEAF WIDTHS

active leaf **80 90E 100** + passive leaf **60 70 80**  
 active leaf **80 90E 100** + solid core, plain side panel **30 40 50**

	DOUBLE FIRE DOOR   TIMBER DOOR FRAME							
	"110"	"120"	"130"	"140"	"150"	"160"	"170"	"180"
<b>A</b> Active door leaf width	860	860   960	860   960   1060	860   960   1060	860   960   1060	860   960   1060	960   1060	1060
<b>B</b> Passive door leaf/Side panel widths	347	447   347	547   447   347	647   547   447	747   647   547	847   747   647	847   747	847
<b>C</b> Frame opening width	1170	1270	1370	1470	1570	1670	1770	1870
<b>F</b> Frame outer width	1278	1378	1478	1578	1678	1778	1878	1978
<b>E</b> Opening width in the wall	1310	1410	1510	1610	1710	1810	1910	2010

### ADJUSTABLE STEEL FIRE DOOR FRAME (OVERLAPPING)

Welded and coated in RAL 9003, 9010, 9016, 8003, 8017, 7016, 7022, 7047, 1001

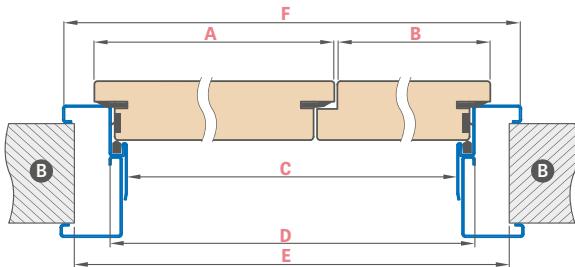

Door width	A	B	C	D	E	F
"110"	860	347	1166	1196	1270	1306
"120"	860   960	447   347	1266	1296	1370	1406
"130"	860   960   1060	547   447   347	1366	1396	1470	1506
"140"	860   960   1060	647   547   447	1466	1496	1570	1606
"150"	860   960   1060	747   647   547	1566	1596	1670	1706
"160"	860   960   1060	847   747   647	1666	1696	1770	1806
"170"	960   1060	847   747	1766	1796	1870	1906
"180"	1060	847	1866	1896	1970	2006

### LARGE STEEL FIRE SQUARE DOOR FRAME (OVERLAPPING)

Welded and coated in RAL 9003, 9010, 9016, 8003, 8017, 7016, 7022, 7047, 1001

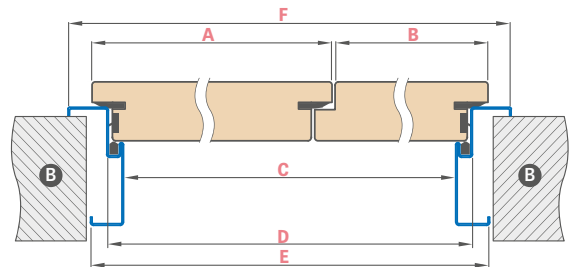

Door width	A	B	C	D	E	F
"110"	860	347	1166	1196	1236	1306
"120"	860   960	447   347	1266	1296	1336	1406
"130"	860   960   1060	547   447   347	1366	1396	1436	1506
"140"	860   960   1060	647   547   447	1466	1496	1536	1606
"150"	860   960   1060	747   647   547	1566	1596	1636	1706
"160"	860   960   1060	847   747   647	1666	1696	1736	1806
"170"	960   1060	847   747	1766	1796	1836	1906
"180"	1060	847	1866	1896	1936	2006

# HARDWARE

## HANDLES FOR FLUSH AND PANELLED DOORS

NEW

### NOVA CLICK handle

stainless steel, matt black

NOVA CLICK handle is available in LEFT and RIGHT versions

The LEFT version of the NOVA CLICK handle is used for:

- right door outwards opening
- left door inwards opening

The RIGHT version of the NOVA CLICK handle is used for:

- right door inwards opening
- left door outwards opening

Door opening directions are shown on page 133.



Stainless steel



matt black

NEW

### CORONA TIME SLIM R handle

brass matt, gunmetal, black matt



brass matt



gunmetal



matt black



HANDLE CLASS  
PREMIUM

NEW

### CORONA IMPERA RT handle

glossy chrome, brushed chrome matt, glossy copper, brushed nickel matt, black matt, white matt



glossy chrome



brushed matt chrome



shiny copper



brushed matt nickel



matt black



White matt



HANDLE CLASS  
PREMIUM

HANDLES FOR FLUSH AND PANELLED DOORS



NEW

CORONA ARROW R handle

glossy chrome, brushed chrome matt, white matt, black matt



glossy chrome



brushed matt chrome



matt black



White matt



NEW

CORONA ARROW Q handle

glossy chrome, brushed chrome matt, white matt, black matt



glossy chrome



brushed matt chrome



matt black



White matt



NEW

CORONA MOON R SLIM handle

glossy chrome, black matt, glossy brass, brass matt



glossy chrome



matt black



glossy brass



brass matt





HANDLES FOR FLUSH AND PANELLED DOORS

NEW

METAL-BUD QUANTA FIT, DIVA FIT, ZOJA FIT, TORA FIT (prestigious 6 mm thick escutcheon) handle

Metal-Bud

PRODUCENT KLAMEK

glossy chrome, brushed nickel, brushed brass, black matt



TORA FIT handle  
matt black



DIVA FIT handle  
brushed nickel



DIVA FIT handle  
brushed brass



DIVA FIT handle  
matt black



ZOJA FIT handle  
brushed nickel



ZOJA FIT handle  
brushed brass



ZOJA FIT handle  
matt black



QUANTA FIT handle  
glossy chrome



QUANTA FIT handle  
brushed nickel



QUANTA FIT handle  
brushed brass



QUANTA FIT handle  
matt black

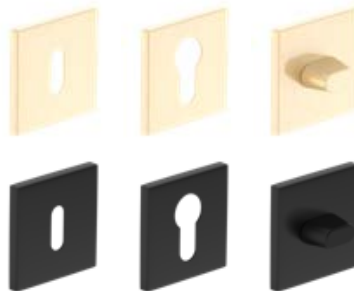

METAL-BUD BELLA SLIM SQUARE handle (prestige 6 mm thick escutcheon)

Metal-Bud

PRODUCENT KLAMEK

glossy chrome, brushed matt chrome, glossy brass, black matt



glossy chrome



brushed matt chrome



glossy brass



brass satin



matt black

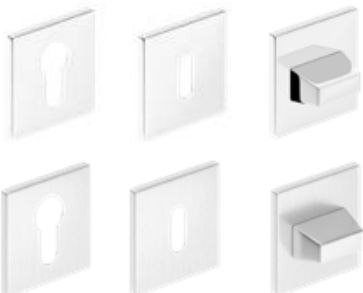

HANDLE CLASS PREMIUM

HANDLES FOR FLUSH AND PANELLED DOORS

METAL-BUD CUBE SLIM handle (prestige 6 mm thick escutcheon)

**Metal-Bud**

PRODUCENT KLAMEK

glossy chrome, brushed matt chrome, glossy brass, black matt

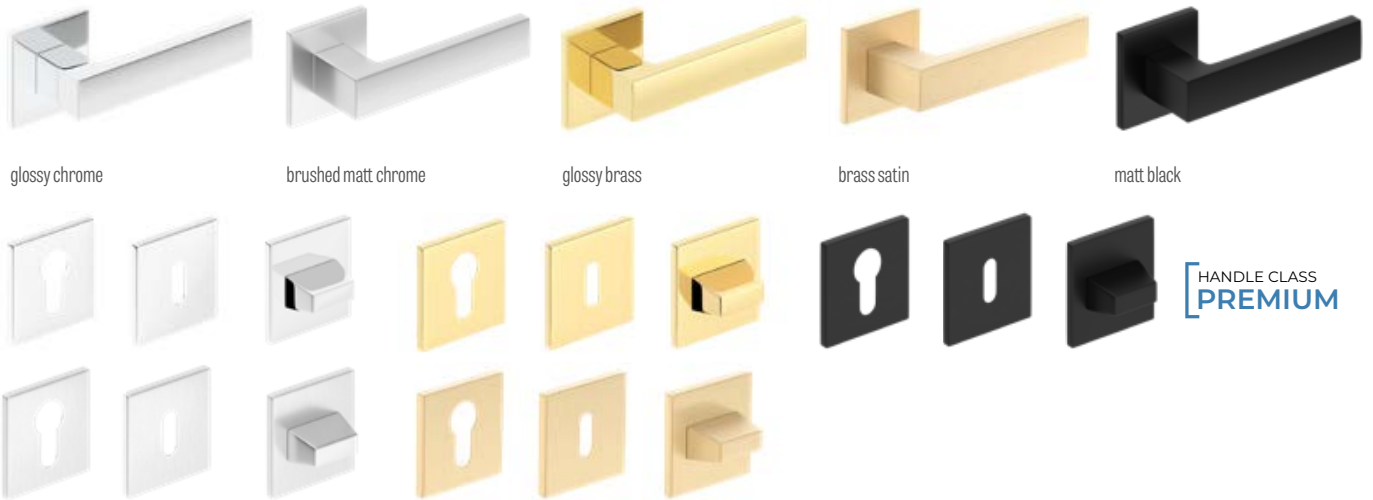

glossy chrome

brushed matt chrome

glossy brass

brass satin

matt black

HANDLE CLASS  
**PREMIUM**

METAL-BUD CUBE handle

**Metal-Bud**

PRODUCENT KLAMEK

glossy chrome, brushed matt chrome, brushed matt nickel, black matt

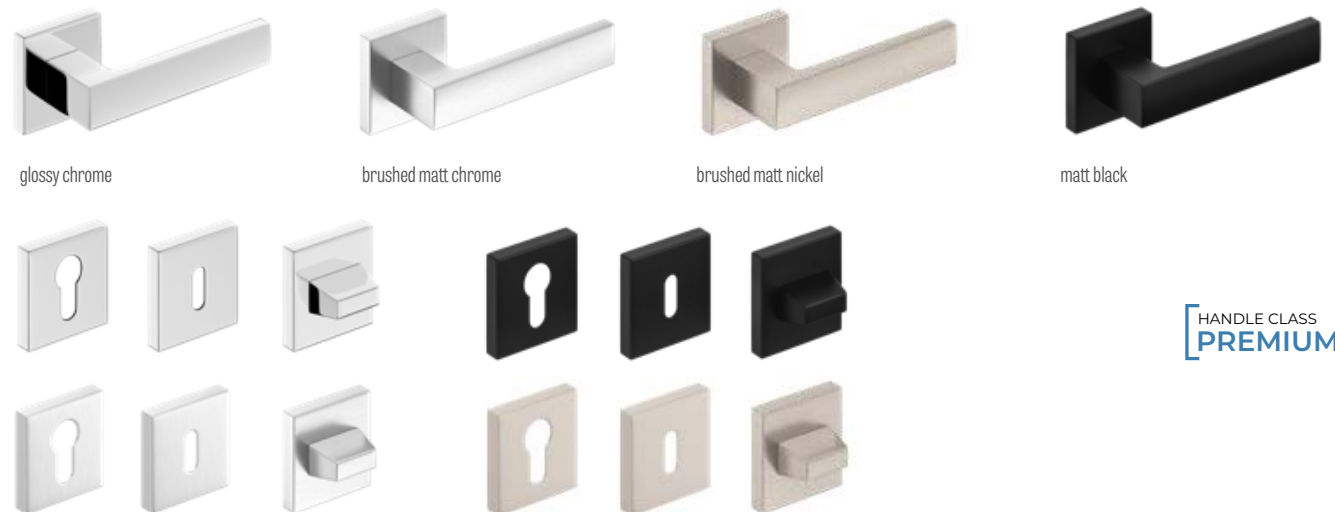

glossy chrome

brushed matt chrome

brushed matt nickel

matt black

HANDLE CLASS  
**PREMIUM**

METAL-BUD CUBE PREMIUM handle

**Metal-Bud**

PRODUCENT KLAMEK

glossy chrome, brushed matt chrome, brushed matt nickel, black matt

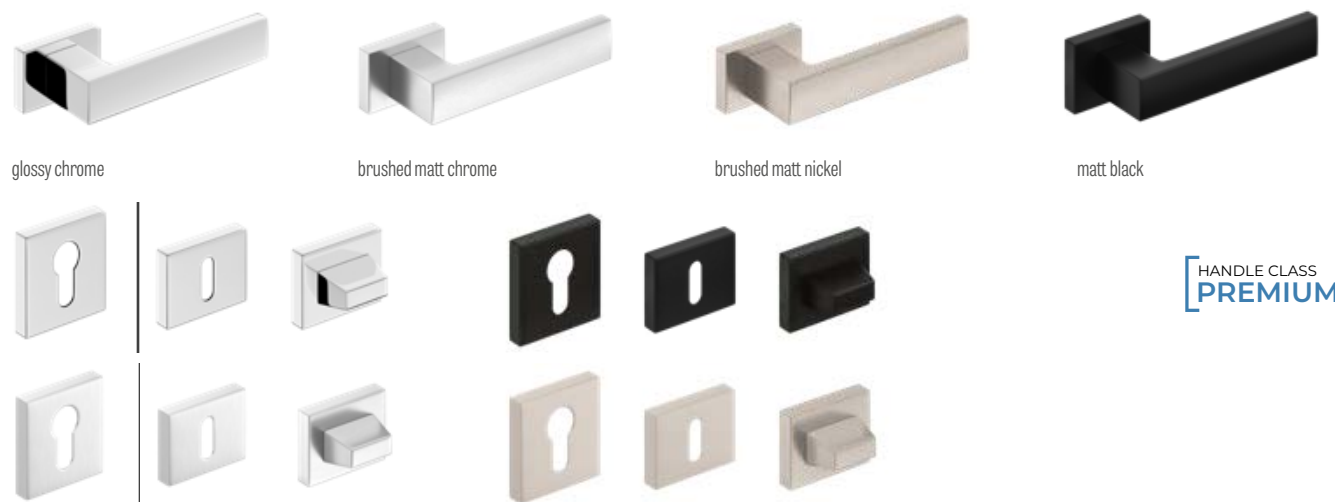

glossy chrome

brushed matt chrome

brushed matt nickel

matt black

HANDLE CLASS  
**PREMIUM**

**HANDLES FOR FLUSH AND PANELLED DOORS**

**NEW**

**METAL-BUD OLIWIA R handle, classic escutcheon**

**Metal-Bud**  
 PRODUCENT KLAMEK

glossy chrome, black matt, glossy brass



glossy chrome



matt black



glossy brass

**NEW**

**METAL-BUD LAURA R handle, classic escutcheon**

**Metal-Bud**  
 PRODUCENT KLAMEK

glossy chrome, black matt, glossy brass



glossy chrome



matt black



glossy brass

**ESCUTCHEON** glossy chrome, black matt, glossy brass for models **OLIWIA R, LAURA R, classic escutcheon**



**NEW**

**METAL-BUD JULIA R handle**

**Metal-Bud**  
 PRODUCENT KLAMEK

glossy chrome, black matt, glossy brass



glossy chrome



matt black



glossy brass

**ESCUTCHEON** glossy chrome, black matt, glossy brass for **JULIA R**



**RUMBA handle with antibacterial coating with active silver ions**

matt black



matt black



HANDLES FOR FLUSH AND PANELLED DOORS

NEW

NOVA handles

PVD matt brass, matt black



PVD matt brass

matt black

NEW

METAL-BUD LUNA SLIM PREMIUM SQUARE handle

glossy chrome, brushed matt chrome, glossy brass, black matt

Metal-Bud

PRODUCENT KLAMEK



glossy chrome

brushed matt chrome

glossy brass

matt black



HANDLE CLASS  
PREMIUM

METAL-BUD BELLA SLIM ROUND (prestige 6 mm thick escutcheon)

glossy chrome, brushed matt chrome, glossy brass, black matt

Metal-Bud

PRODUCENT KLAMEK



glossy chrome

brushed matt chrome

glossy brass

brass satin

matt black

NEW

METAL-BUD LUNA SLIM PREMIUM handle, ROUND

glossy chrome, brushed matt chrome, glossy brass, black matt

Metal-Bud

PRODUCENT KLAMEK



glossy chrome

brushed matt chrome

glossy brass

matt black



HANDLE CLASS  
PREMIUM



**HANDLES FOR FLUSH AND PANELLED DOORS**

**METAL-BUD DECO texture handle**

**Metal-Bud**

PRODUCENT KLAMEK

glossy chrome, nickel satin



facing layer: MEDIUM GREKO OAK



facing layer: BLACK



facing layer: WHITE GREKO



facing layer: GREKO SONOMA



facing layer: GREKO WALNUT



facing layer: GREKO OAK

**METAL-BUD IBIZA handle**

glossy chrome, nickel satin, graphite/chrome, white matt, black matt



glossy chrome



graphite/chrome



nickel satin



white matt



matt black

**METAL-BUD LINEA handle**

Glossy chrome, graphite/chrome, nickel, satin



glossy chrome



graphite/chrome



nickel satin

**METAL-BUD TREND handle**

Nickel satin, graphite/chrome, glossy chrome



nickel satin



graphite/chrome



glossy chrome

**ESCUTCHEON** Glossy chrome, nickel satin, graphite/chrome, white matte, black matte for **DECO, DECO, IBIZA, LINEA, TREND**

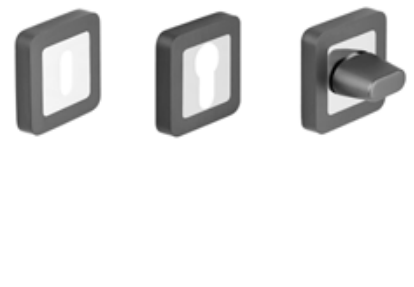

**HANDLES FOR FLUSH AND PANELLED DOORS**

**METAL-BUD QUBIK handle**

nickel velvet, glossy chrome, white matt, black matt

**Metal-Bud**

PRODUCENT KLAMEK



QUBIK handle, nickel, velvet



QUBIK handle, glossy chrome

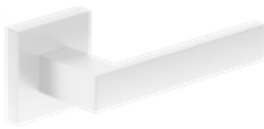

QUBIK handle, white matt



QUBIK handle, black matt



QUBIK handle, glossy brass

**METAL-BUD BARCELONA handle**

velvet nickel, glossy chrome, matt black, brushed nickel

**Metal-Bud**

PRODUCENT KLAMEK



BARCELONA handle, nickel, velvet



BARCELONA handle, glossy chrome



BARCELONA handle, black matt



BARCELONA handle brushed nickel

**ESCUTCHEON** nickel, velvet, glossy chrome, white matt, black matt, glossy brass, brushed nickel, for the **QUBIK, BARCELONA** models

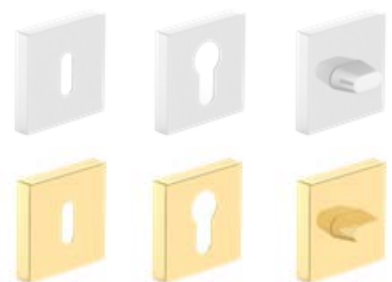
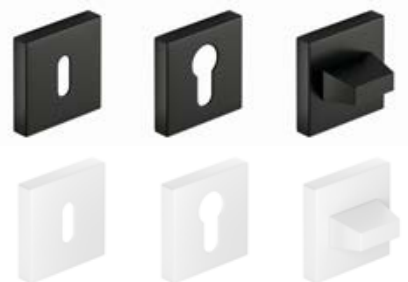
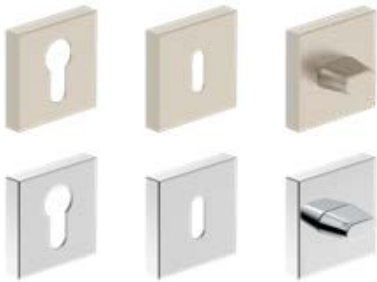

**GAMET handles**

glossy chrome, brushed nickel, antique brass



MISTICO handle  
glossy chrome



MISTICO handle  
brushed nickel



ERBA handle  
brushed nickel



ERBA handle  
antique brass



CASCADA handle  
brushed nickel



CASCADA handle  
antique brass





## HANDLES FOR FLUSH AND PANELLED DOORS

NEW

### METAL-BUD MONDO handle

**Metal-Bud**

PRODUCENT KLAMEK

nickel satin



MONDO handle, nickel satin



Euro profile escutcheon



Escutcheon - keyhole profile



Escutcheon - bathroom

### METAL-BUD ERKADO handle

**Metal-Bud**

PRODUCENT KLAMEK

matt black



TOPAZ handle, black matt



Euro profile escutcheon



Escutcheon - keyhole profile



Escutcheon - bathroom

### METAL-BUD ERKADO handles

inox



SUPRA inox square handle



SUPRA inox round handle



PROXIMA inox round handle



SAPPHIRE inox handle



METRO inox handle



PROXIMA inox square handle



TOPAZ inox handle



ONYX inox handle



NOVA inox square handle



NOVA inox round handle



JOWISZ inox handle



ROMA inox handle



Escutcheon - euro profile, inox



Escutcheon - keyhole profile, inox



Escutcheon - bathroom, inox



Escutcheon - euro profile, inox



Escutcheon - keyhole profile, inox



Escutcheon - bathroom, inox

## HANDLES FOR FLUSH AND PANELLED DOORS

NEW

### CAMILA handles

satin chrome, matt black



NEW



NEW



CAMILA handle chrome, satin

CAMILA handle, black matt

## HANDLES FOR FLUSH AND PANELLED DOORS ON BACKPLATE

The handles on backplate are not used for non-rebated doors (see p. 137)

NEW

### handles: BLANKA, CAMILA, JULIA, LUNA backplate

satin chrome, shiny brass



BLANKA handle chrome, satin



NEW

CAMILA handle chrome, satin



JULIA handle, glossy brass



LUNA handle, glossy brass

## METAL-BUD JOWISZ INOX handles on backplate (10 mm thick), spacing 72 mm

CERTIFIED FOR USE IN LEDA EI30 AND EI 60 FIRE AND FRONT DOORS

stainless steel, investment

**Metal-Bud**

PRODUCENT KLAMEK



JOWISZ INOX handle  
Escutcheon - keyhole profile



JOWISZ INOX handle  
Escutcheon - bathroom



JOWISZ INOX handle  
Euro profile escutcheon



JOWISZ INOX handle  
Escutcheon, latch

## METAL-BUD TOPAZ INOX handle on backplate (10 mm thick), spacing 72 mm

stainless steel

**Metal-Bud**

PRODUCENT KLAMEK



TOPAZ INOX handle  
Escutcheon - keyhole profile



TOPAZ INOX handle  
Escutcheon - bathroom



TOPAZ INOX handle  
Euro profile escutcheon



TOPAZ INOX handle  
Escutcheon, latch

## HANDLES FOR FLUSH AND PANELED DOORS ON BACKPLATE

The handles on backplate are not used for non-rebated doors (see p. 137)

### METAL-BUD ASTRA, SYDNEY and QUBIK handles on backplate, spacing 72 mm

- the SYDNEY and QUBIK handles not to be used for flush doors with casing frames, see p. 166

**Metal-Bud**

PRODUCENT KLAMEK

nickel, patina, matt black



## HANDLES FOR HERSE SET, HERSE LUX SET, HERSE MAX SET

### METAL-BUD ERKADO BONN & ESSEN handles <sup>1)</sup> (backplate thickness ESSEN – 10 mm, BONN – 8 mm), spacing 72 mm



BONN handle

BONN handle, black matt



ESSEN handle <sup>1)</sup>

## LOCK CORES



Lock core, nickel satin



Lock core with thumbturn,  
nickel satin

Lock cores in the master key system 30/45 + 30G/45  
Outswing doors – silver, black

Lock cores in the master key system 30/45 + 30/45G  
Inswing doors – silver, black

LOCK CORE	LOCK CORE WITH THUMBTURN
Size	Size
26/36	G30/40
30/30	G40/30
30/40	G30/50
30/45	G50/30
30/50	30/45G
	30G/45

<sup>1)</sup> ESSEN handles and escutcheons cannot be used with a multipoint lock

# TECHNICAL INFORMATION

## DOOR OPENING DIRECTIONS

SINGLE DOOR LEFT DOOR LEAF

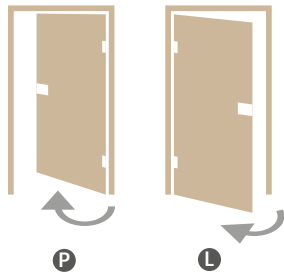

SINGLE DOOR RIGHT DOOR LEAF

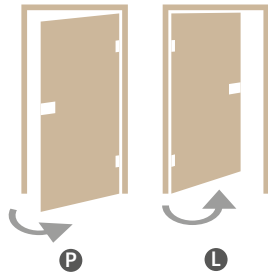

## REBATED, NON-REBATED, REVERSE DOORS

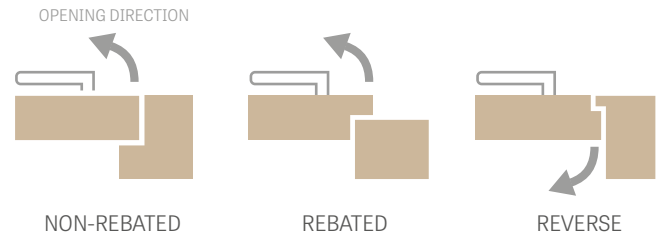

## NOVA CLICK HANDLE

LEFT VERSION  
L



RIGHT VERSION  
P

## DOOR FRAME JOINTS



## DOUBLE DOORS



## HOW TO SELECT A LOCK CORE

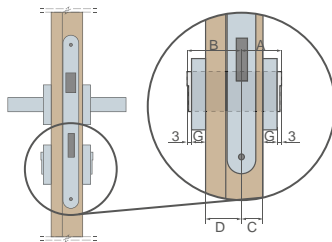

Example of calculating the lock core size for the flush and panelled doors (40mm) with the escutcheon thickness of G = 7 mm

$$A/B = (C+G+3) / (D+G+3)$$

$$A/B = (15+7+3) / (25+7+3)$$

$$A/B = 25/35$$

Door type	Door leaf thickness	Proportion of lock setting in door (C/D)	Recommended lock core size (A/B)*
flush, panelled (rebated)	40 mm	15/25	26/36
flush, panelled (non-rebated)	40 mm	20/20	30/30
reverse	40 mm	15/25	26/36
HERSE	46 mm	15/31	30/45
LEDA EI 30	50 mm	19/31	30/40
LEDA EI 60	60 mm	19/41	30/50
FORTECA RC2 & RC3	46 mm	20/26	30/40
HYPERION EI30 RC2	50 mm	19/31	30/40

\* Recommended lock core size for the escutcheon thickness of 7 mm and play of 2 mm to 4 mm

## HOW TO CALCULATE DOOR PRICE

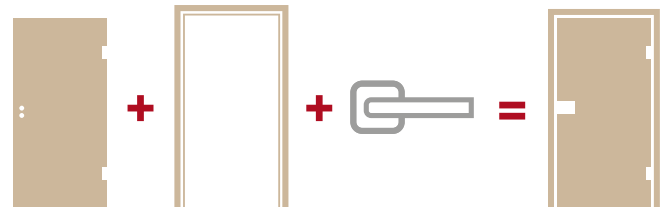

## AVAILABLE SOLUTIONS (pp. 142-153)

- wall-mounted sliding door systems, single door

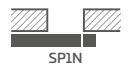

- wall-mounted sliding door systems, double door

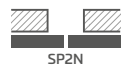

- pocket sliding door systems, single door



- pocket sliding door systems, double door



- supplementary system ZN1



- supplementary system ZN2



- double doors



## DOOR FACE FINISH TYPES

### GREKO

The Greko foil is also pre-impregnated, which means printing and then coating with paint with required properties. Using the performance finishing coats adds to the surface's resistance and flexibility of the product. The paint's silicon content ensures the film resistance is enhanced. The Greko foil is manufactured on a high density Japanese base layer which is not resin coated. This makes the film ecological, healthy and safe for people and environment both in the production process and during use, as well as for disposal. No formaldehyde or other harmful ingredients is used.

Its distinctive patterns are what distinguishes the Greko film. The facing layers bear striking resemblance to wood, as the high quality surface comes with a 3D natural wood effect. The facings look just like wood.

### PREMIUM

The PREMIUM facing is a product based on Polypropylene (PP), a material of very high resistance to abrasion and scratching, plus top quality appearance. It adds a refined looks and individual character to the doors, as it imitates natural wood perfectly.

Not only does the PREMIUM facing attracts with its appearance but with its functionality, as it resists scratching better than average products and is fire-retardant and abrasion resistant. These properties ensure the extended longevity and maintenance-free use of the PREMIUM range products even in most adverse conditions.

### ST CPL, CPL 0.2 and CPL 0.7

The CPL facing is composed of a decorative layer impregnated in resins, and a base layer ensuring flexibility. Following the lamination process, the top resin layer is hardened for high resistance to scratching and abrasion. It is characterised by high resistance to impact, abrasion, scratching, heat and UV radiation

Thanks to using this type of material, the door can be installed in so-called "difficult" interiors [exposed to heat, moisture or extraordinary use]. Approx. laminate thickness: ST CPL - 0.15 mm, CPL 0.2 - 0.2 mm and CPL 0.7 - 0.7 mm. The CPL 0.7 laminate is used to cover only one leaf plane thanks to its unique hardness. The CPL 0,2 and CPL 0.7 laminated door leaves come with the leaf edge made of the so-called ABS, a highly durable PVC.

ST CPL facing in white, light grey, cappuccino, black has been refined in the AntiFinger coating limiting dirt and fingerprints. **NEW**

### UV VARNISH

The door surface has several coats of the WHITE TITANIUM UV modern UV hardened varnish. The flat surfaces are covered with a specialist base membrane in the first phase, and then coated twice with a top quality paint and hardened with UV.

The moulded surfaces cannot be covered with the membrane for technological reasons, so they are coated with three paint layers and hardened with UV.

The fully automatic coating process follows scanning to ensure ideal quality of the surface. Hardening the paint with the cutting-edge method involving UV light source ensures very high mechanical resistance.

## EDGE FINISH TYPES

### SOFT EDGE



The SOFT door leaf comes with a chamfered edges, which lends an aesthetic and modern look to it. The leaf is finished with a facing layer of an improved resistance to scratching, which dramatically enhances its resistance during use.



### STANDARD EDGE



It involves covering the flat plane with the 0.15 mm ST CPL, CPL 0.2, CPL 0.7 facings, polypropylene PREMIUM facing or GREKO foil.

The door leaf made in STANDARD technology has unchamfered edges, which is where the face panel is joined with edges facing, as shown in the diagram. The veneer in the CPL 0.2 and CPL 0,7 laminates is made of very durable PVC, the so-called ABS. The joining method of the facing is also identical for the non-rebated doors and non-rebated sliding systems.



<sup>1)</sup> applies only to BALDUR 1 in WHITE ST CPL facing with solid core filling

## STILE PANELLED DOOR

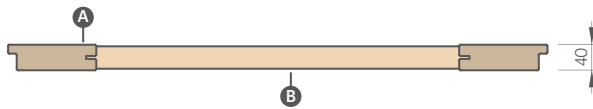
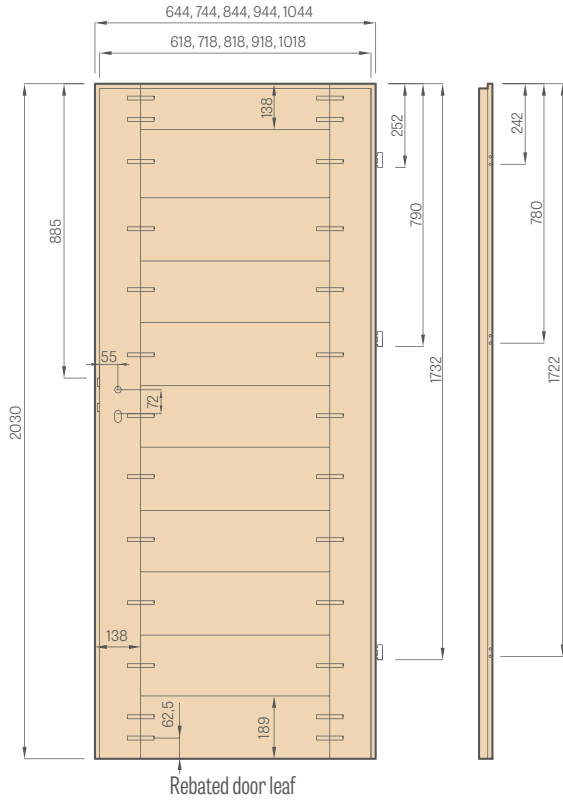

- A MDF stiles
- B MDF rails



Solid 35 mm or 22 mm thick rail



Aesthetic frameless tongue-and-groove glazing without bars



MDF stile for the GREKO, PREMIUM and CPL facings, also with the AntiFinger coating

**NEW**



Glulam timber stile covered with HDF and MDF boards available at a surcharge for the following facing layers: WHITE PREMIUM, OAK NATUR PREMIUM, GRAPHITE ASH PREMIUM, GREY MAPLE PREMIUM, OAK ST CPL

## FLUSH DOOR

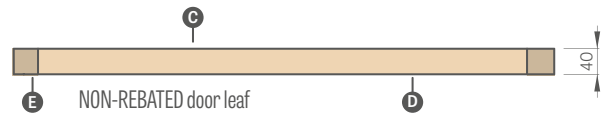
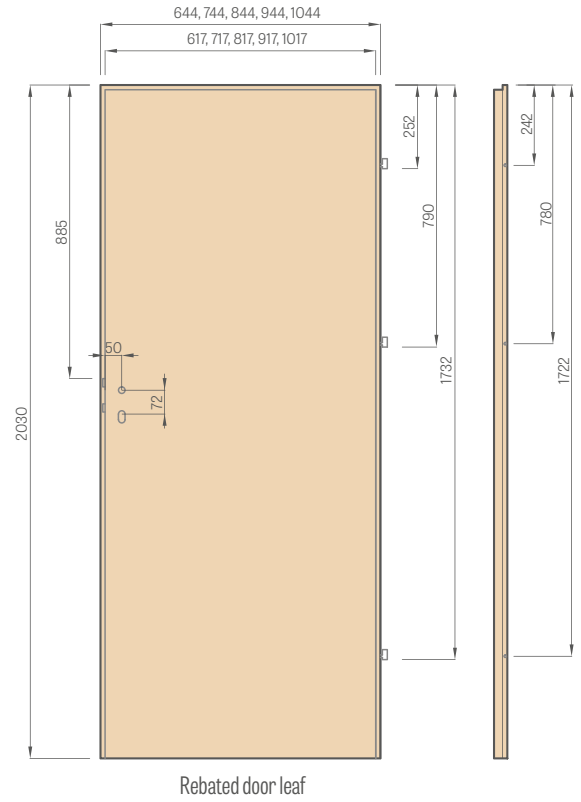

- A MDF board; B gasket; C HDF board; D filling;
- E MDF or timber stiles in Herse SET and UNO PREMIUM

## FILLING TYPES

Honeycomb



Solid core filling



The honeycomb and the solid core filling in the flush doors ONLY. For the solid core doors we add a third hinge as standard.

## GRAF GLASS PANEL

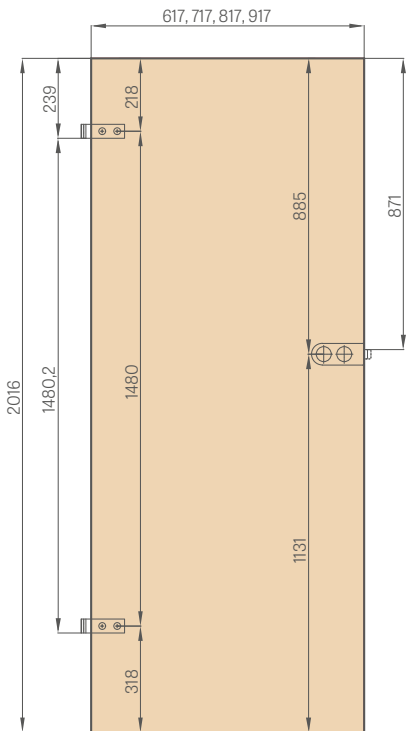

## FIRE DOOR LEAF

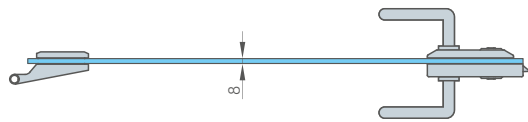
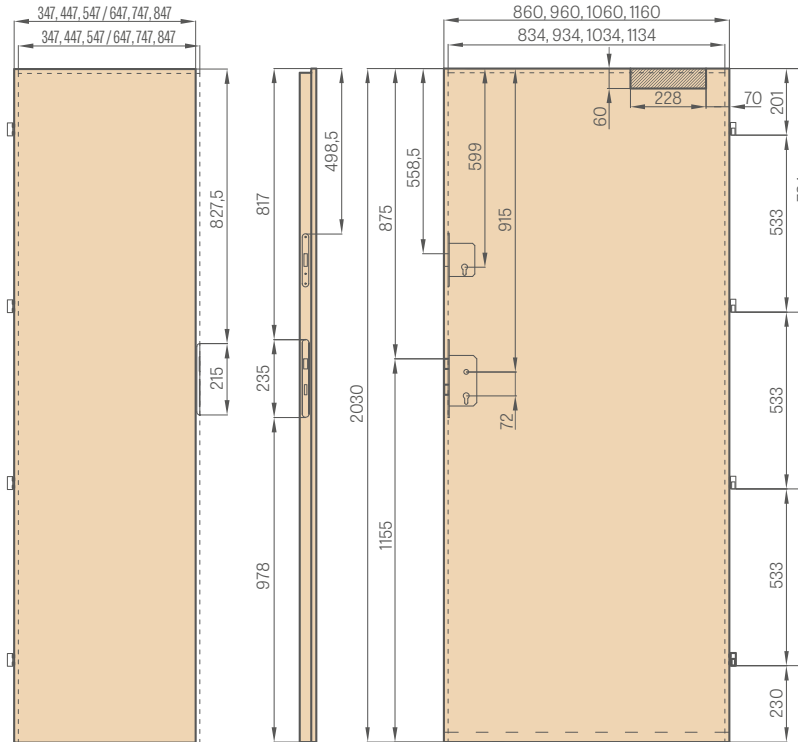

Side panel / inactive door leaf

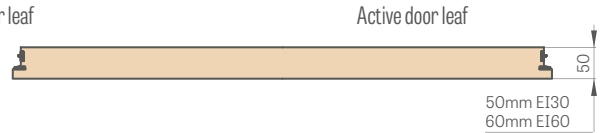

Active door leaf

## BATHROOM TURN & RELEASE

outside (Z)

inside (W)

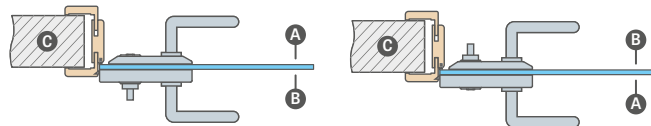

**A** Corridor; **B** Bathroom; **C** Wall

Bathroom lock – for turn and release locks, select:

- OUTSIDE lock – with the bathroom turn and release is fitted to the outside of the door (Z)
- or
- INSIDE lock – with the bathroom turn and release is fitted to the inside of the door (W)

**NOTE:** Directions for the turn and release locks apply (R/L)



Specially designed HALSPAN board filling  
44 mm [EI30] / 54 mm [EI60]



Fire rated and smoke intumescent door gasket in red or black



Drop-down gasket with pressure adjustment by Allen key



Fixed door frame

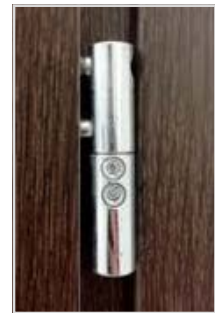

Useful four hinges  $\varnothing 16$  with 3D adjustment

## STANDARD OBLVERSE GLAZING



## REVERSE GLAZING MADE TO ORDER

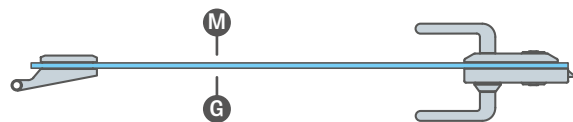

**G** Plain side; **M** ornamental matt side;

## CONCEALED MAGNETIC STOPS NEW



glossy chrome, chrome satin, glossy brass, colourless, white semi-matt, black semi-matt



We assemble the magnetic door stop in a special place milled for this purpose on our own. Product delivered as a separate assortment.  
**Caution** (important information in case of underfloor heating): the floor element should be placed in the  $\varnothing 14$  mm hole, 45 mm deep.  
 Magnetic door stop not available for double-leaf doors.

## METAL CAPS FOR HINGES

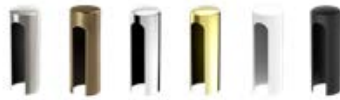

brushed nickel, patina, glossy chrome, glossy brass, white matt and black matt

Available casings:

- for Herse/Forteca  $\varnothing 16$ , length 47 mm in colours: brushed nickel, patina, chrome gloss, brass gloss, white and black
- Hyperion, Leda  $\varnothing 16$ , length 64 mm in chrome matt and black colours
- for interior leaves  $\varnothing 15$ , length 47 mm in colours: brushed nickel, patina, chrome gloss, brass gloss, white and black

## VENTILATION



Square and round metal sleeves

Plastic woodgrain sleeves for STILE panelled doors for GREKO, PREMIUM and CPL facing layers

Grilles



## VENTILATION FOR AIR TIGHT HOMES

**Enhanced airflow trim** – a door is cut at the bottom by 15 mm along its full width. According to standard, doors have to allow a gap of approx. 9 mm above a final floor covering, so a total air gap, including the enhanced airflow trim, is approx. 24 mm.  
 Enhanced airflow trim not available in the double-leaf door version.

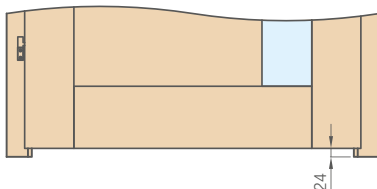

## STANDARD VENTILATION (H. 32 mm) or MINI (H. 15 mm)

Air gap undercut is not available in non-rebated doors for wall-mounted and pocket sliding doors.

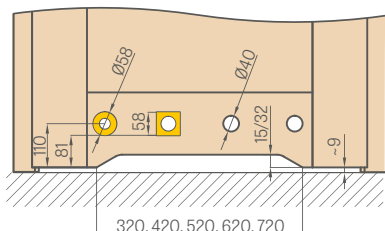

## ELECTRIC DOOR STRIKE

(available for fixed and adjustable door frames for rebated and non-rebated doors, see p. 168-171 but unavailable for the door frames used with the GRAF glass panes and double doors)

Types of electric door strikes:

- basic 12 V
- basic 24 V
- switch operated 12 V
- switch operated 24 V
- reverse 12 V
- reverse 24 V



- BASIC** – normally closed, and opened when voltage is fed
- SWITCH OPERATED** – same operation as in the basic strike, but with an option to be switched off by moving the springbolt
- REVERSE** – closed when voltage is fed, opened when not

The reverse and switch operated electric door strikes unavailable for the fire doors

## CUTTING THE DOOR LEAVES

Cutting the door leaves to size by customer acc. to Polish standard, up to 50 mm, or up to 80 mm for the HERSE SET door leaves (unless pre-cut), as well as in the flush doors, is possible if an additional lower rail has been fitted by the manufacturer.

(NOTE: cutting the door leaves to size by customer is not allowed for the FRAGI doors, double and fire doors, non-rebated leaves for sliding systems, glass GRAF doors, FORTECA RC2 and FORTECA RC3 burglar-proof doors, and panelled doors acc. to the CZ standard).

**The door leaf height made acc. to the so-called CZ standard is lower than the PL standard by 47 mm.**

**Factory shortening of the door lowers the handle by the same height.**

Leaf type	Handle height as per PL standard (measured from the bottom edge of the door) [mm]
STILE rebated panelled leaves	1107
STILE non-rebated panelled leaves	1110
rebated flush doors	1110
non-rebated flush doors	1110
reverse flush door	1110
GRAF glass doors	1131
FORTECA RC2 & RC3 doors	1038
HERSE, HERSE AKUSTIC doors	1107
HERSE door with a strip lock	1033
HERSE UNITED door	1117
LEDA EI30, EI60 door	1115
HYPERION EI30 RC2 door	1033

## HARDWARE – LEVER TUMBLER LOCKS

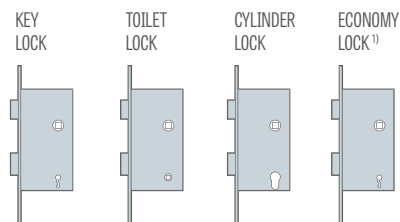

### LOCK PZ CENTRES:

- The magnetic lock PZ centres:
  - for keys, toilet doors: 90 mm
  - for lock cores: 85 mm
 (non-rebated door leaves with a magnetic lock and reversed swing doors)
- The lever tumbler lock PZ centres:
  - for keys, toilet doors, lock core: 72 mm
 (rebate door leaves and non-rebated door leaves with optional lever tumbler locks)

The toilet locks have a square-shaped bolt hole:

- acc. to PL standard: 4 mm
- acc. to CZ standard: 6 mm

<sup>1)</sup> lock provided without a keyhole in the leaf

## STANDARD "OBSERVE" GLAZING

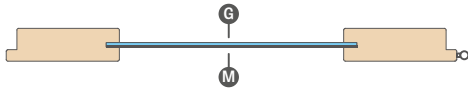

## "REVERSE" GLAZING MADE TO ORDER

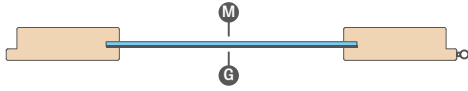

G plain side M matt side with decoration or colourless side with decoration

## FROSTED and BLACK VSG 221, 331, 441 LAMINATED GLASS

for STILE panelled doors and flush doors

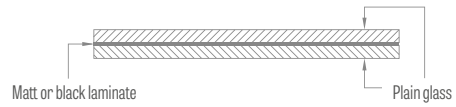

## CLEARANCE UNDER DOOR LEAF AFTER INSTALLATION

Please check the lower clearance dimensions on all products prior to installation, as the allowable deviation due to frame dimensional tolerance is  $\pm 3$ mm

## GLAZING TRANSLUCENCY ILLUSTRATION



GRAF 1  
tempered, painted glass



GRAF 12  
tempered, painted glass



GRAF 8  
decormat



GRAF 9  
transparent



GRAF 26  
dark grey



GRAF 29  
laminated glass



GRAF 11 Decormat  
graphite



Tempered glass  
decormat frosted



Black VSG  
or VSG/ESG



Frosted VSG  
or VSG/ESG

## FACTORY-DRILLED HANDLE OPENINGS



Factory-drilled handle opening in panelled doors for handles with separate escutcheons available from Erkado.

## NON-REBATED & REVERSE HARDWARE



Concealed hinge



Magnetic catch



adjustable magnetic catch strike



Concealed hinge, black



Magnetic lock, black



adjustable magnetic catch strike, black



Concealed hinge, golden



Magnetic lock, golden



Adjustable magnetic catch strike, golden

## INSTALLATION OF FRAME FOR NON-REBATED DOOR FRAMES

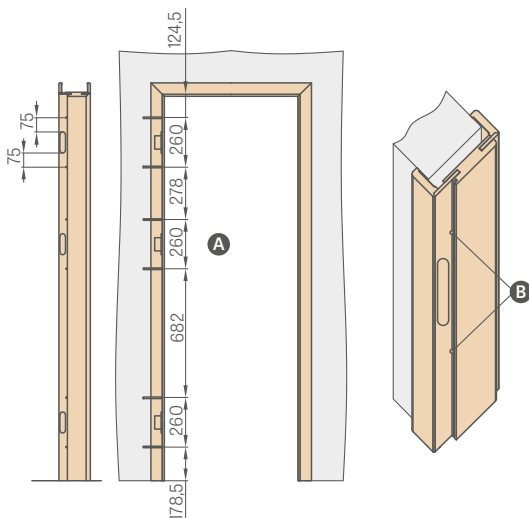

- A Drill holes for metal screws of min length 80 mm x  $\varnothing$ 6 mm
- B Apart from installation foam, mounting anchors are required when installing the door frame. Drill the holes for screws under the gasket so that it hides them.

## CLEANING, REVITALISATION & REGENERATION KIT FOR OTTIMO DOORS



# CROSSHEADS AND PILASTERS

PEONIA 1, ASHY ST CPL facing layer with CUBE PREMIUM handle, decorative crossheads

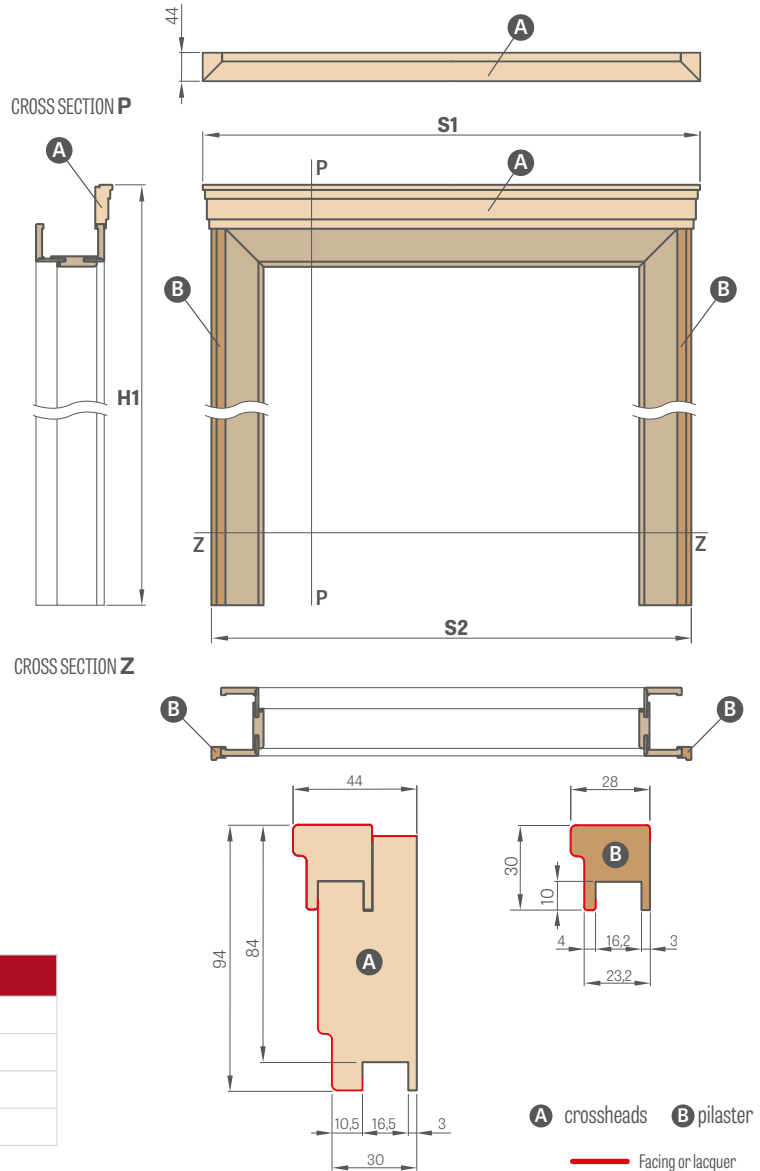

**PRICE OF THE SET<sup>1)</sup> (CROSSHEADS + PILASTERS)**

GREKO	
ST CPL & PREMIUM	
CPL 0.2 and CPL 0.7	
PAINTED	

<sup>1)</sup> the price is for a single-sided set; PL2112 standard - surcharge 15 %  
Set for double-leaf doors - 30 % surcharge

Door width	DOOR FRAME and ADJUSTABLE REBATED TUNNEL		DOOR FRAME and ADJUSTABLE NON-REBATED TUNNEL		ADJUSTABLE REVERSE DOOR FRAME	
	S1	S2	S1	S2	S1	S2
"60"	838 <sup>2)</sup> /878 <sup>3)</sup>	788 <sup>2)</sup> /828 <sup>3)</sup>	863 <sup>2)</sup> /903 <sup>3)</sup>	813 <sup>2)</sup> /853 <sup>3)</sup>	883 <sup>4)</sup> /926 <sup>5)</sup>	833 <sup>4)</sup> /876 <sup>5)</sup>
"70"	938 <sup>2)</sup> /978 <sup>3)</sup>	888 <sup>2)</sup> /928 <sup>3)</sup>	963 <sup>2)</sup> /1003 <sup>3)</sup>	913 <sup>2)</sup> /953 <sup>3)</sup>	983 <sup>4)</sup> /1026 <sup>5)</sup>	933 <sup>4)</sup> /976 <sup>5)</sup>
"80N"	-	-	1039 <sup>2)</sup> /1079 <sup>3)</sup>	989 <sup>2)</sup> /1029 <sup>3)</sup>	1058 <sup>4)</sup> /1100 <sup>5)</sup>	1008 <sup>4)</sup> /1050 <sup>5)</sup>
"80"	1038 <sup>2)</sup> /1078 <sup>3)</sup>	988 <sup>2)</sup> /1028 <sup>3)</sup>	1063 <sup>2)</sup> /1103 <sup>3)</sup>	1013 <sup>2)</sup> /1053 <sup>3)</sup>	1083 <sup>4)</sup> /1126 <sup>5)</sup>	1033 <sup>4)</sup> /1076 <sup>5)</sup>
"90"	1138 <sup>2)</sup> /1178 <sup>3)</sup>	1088 <sup>2)</sup> /1128 <sup>3)</sup>	1163 <sup>2)</sup> /1203 <sup>3)</sup>	1113 <sup>2)</sup> /1153 <sup>3)</sup>	1183 <sup>4)</sup> /1226 <sup>5)</sup>	1133 <sup>4)</sup> /1176 <sup>5)</sup>
"100"	1238 <sup>2)</sup> /1278 <sup>3)</sup>	1188 <sup>2)</sup> /1228 <sup>3)</sup>	1263 <sup>2)</sup> /1303 <sup>3)</sup>	1213 <sup>2)</sup> /1253 <sup>3)</sup>	1283 <sup>4)</sup> /1326 <sup>5)</sup>	1233 <sup>4)</sup> /1276 <sup>5)</sup>
"110"	1338 <sup>2)</sup> /1378 <sup>3)</sup>	1288 <sup>2)</sup> /1328 <sup>3)</sup>	1363 <sup>2)</sup> /1403 <sup>3)</sup>	1313 <sup>2)</sup> /1353 <sup>3)</sup>	1383 <sup>4)</sup> /1426 <sup>5)</sup>	1333 <sup>4)</sup> /1376 <sup>5)</sup>

<sup>2)</sup> square with architrave 6 cm, <sup>3)</sup> square with architrave 8 cm, <sup>4)</sup> reverse architrave, <sup>5)</sup> adjustable square RW

	H1					
	DOOR FRAME and ADJUSTABLE REBATED TUNNEL		DOOR FRAME and ADJUSTABLE NON-REBATED TUNNEL		ADJUSTABLE REVERSE DOOR FRAME	
	Square with architrave 6 cm	Square with architrave 8 cm	Square with architrave 6 cm	Square with architrave 6 cm	Reverse architrave	Adjustable square
PL STANDARD	2174	2194	2187	2207	2207	2229
PL 2112 STANDARD	2256	2276	2269	2289	-	-

**NOTE:** The working range of frame will be reduced by 3 mm (for single-sided use) or 6 mm (for double-sided use) when a set (crossheads + pilasters) for the rebated, non-rebated or reverse adjustable frame is selected. Example: assume a 140 mm thick wall with a single-sided set to be 143mm thick, while with a double-sided set to be 146 mm thick, and look for a corresponding masonry coverage in the table for rebated frames (p. 171), non-rebated frames (p. 168) or reverse frames (p. 167).

# DOOR FRAME EXTENSION PANELS

## WALL-MOUNTED

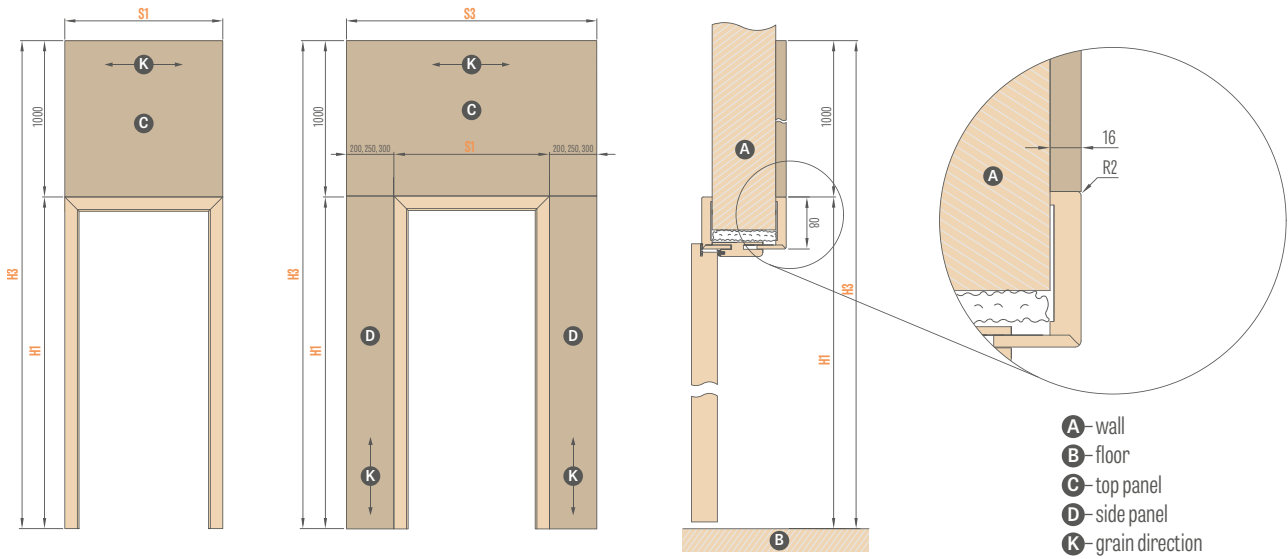

- A** - wall
- B** - floor
- C** - top panel
- D** - side panel
- K** - grain direction

INTERNAL DOORS <sup>1)</sup>				
Frame type	H1	H3	Width	S1
Adjustable rebated door frame	2109	3109	"60"	786
			"70"	886
			"80"	986
			"90"	1086
			"100"	1186
Adjustable non-rebated door frame	2122	3122	"60"	811
			"70"	911
			"80N"	987
			"80"	1011
			"90"	1111
Reverse door frame (flush with the leaf)	2122	3122	"60"	791
			"70"	891
			"80N"	966
			"80"	991
			"90"	1091
REVERSE DOOR FRAME	2144	3144	"60"	834
			"70"	934
			"80N"	1010
			"80"	1034
			"90"	1134
			"100"	1234
			"110"	1334
<b>TOP PANEL (1000 x S1) <sup>1)</sup></b>				

FRONT DOOR (panels on the staircase side door opening inwards)										
Frame type	H1	H3	Width	S1	S3					
Adjustable HERSE door frame	2109	3109	"80"	986	1186	1236	1286	1386	1486	1586
			"90E"	1090	1290	1340	1390	1490	1590	1690
			"100"	1186	1386	1436	1486	1586	1686	1786
			"80N"	1012	1212	1262	1312	1412	1512	1612
HERSE fixed door frame "clip-on"	2142	3142	"80"	1052	1252	1302	1352	1452	1552	1652
			"90E"	1156	1356	1406	1456	1556	1656	1756
			"100"	1252	1452	1502	1552	1652	1762	1852
FORTECA fixed "clip-on" door frame	2147	3147	"80N"	1012	1212	1262	1312	1412	1512	1612
			"80"	1056	1256	1306	1356	1456	1556	1656
			"90E"	1156	1356	1406	1456	1556	1656	1756
			"100"	1256	1456	1506	1556	1656	1756	1856
FORTECA fixed frame with adjustment (installation side)	2136	3136	"80N"	990	1190	1240	1290	1390	1490	1590
			"80"	1034	1234	1284	1334	1434	1534	1634
			"90E"	1134	1334	1384	1434	1534	1634	1734
LEDA, HYPERION fixed door frame "clip-on"	2147	3147	"80"	1085	1285	1335	1385	1485	1585	1685
			"90E"	1185	1385	1435	1485	1585	1685	1785
			"100"	1285	1485	1535	1585	1685	1785	1885
LEDA, HYPERION adjustable fixed frame (installation side)	2136	3136	"80"	1063	1263	1313	1363	1463	1563	1663
			"90E"	1163	1363	1413	1463	1563	1663	1763
			"100"	1263	1463	1513	1563	1663	1763	1863
					<b>PANEL 200</b>	<b>PANEL 250</b>	<b>PANEL 300</b>	<b>2 x PANEL 200</b>	<b>2 x PANEL 250</b>	<b>2 x PANEL 300</b>
					<b>SINGLE-FACE SIDE PANEL</b>			<b>DOUBLE-FACE SIDE PANEL</b>		

DOOR FRAME EXTENSION PANELS <sup>2)</sup> – price per m <sup>2</sup>	
<b>GREKO</b>	
<b>CPL 0.2, ST CPL and PREMIUM</b>	
<b>PAINTED</b>	

<sup>1)</sup> only top panels are available for interior door frames

<sup>2)</sup> the panels shall be edged on all four edges in a colour similar to that of the panel surface. The area is calculated from the tables above.

# INTEGRATED ONE-SIDE EXTENSION PANELS

MOUNTED INSTEAD OF AN ADJUSTABLE SQUARE OR WITH A CLIP

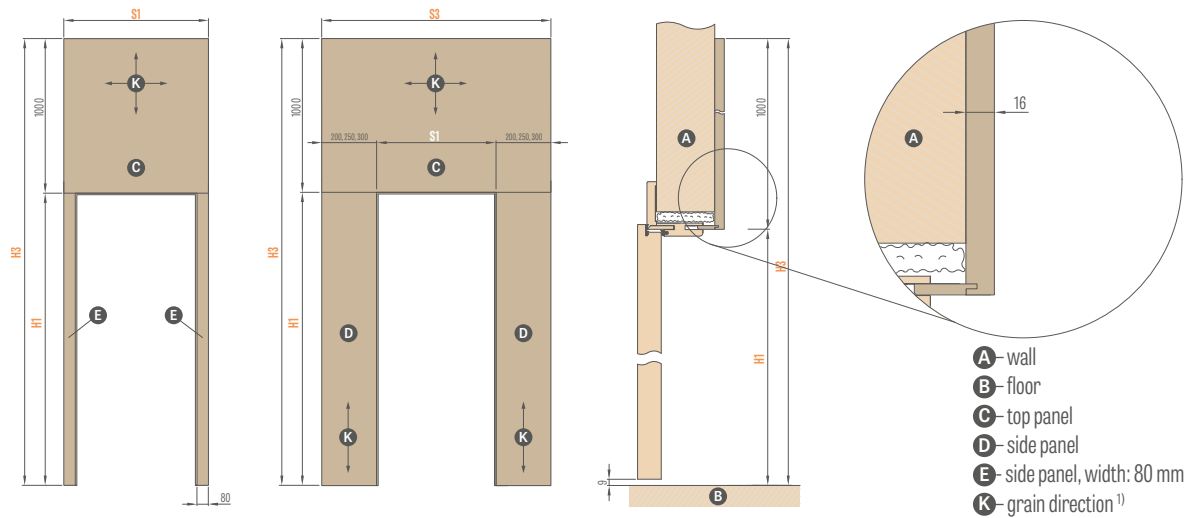

- A** – wall
- B** – floor
- C** – top panel
- D** – side panel
- E** – side panel, width: 80 mm
- K** – grain direction <sup>1)</sup>

INTERNAL DOORS <sup>2)</sup>				
Frame type	H1	H3	Width	S1
Adjustable rebated door frame (adjustable square section side)	2029	3029	"60"	786
			"70"	886
			"80"	986
			"90"	1086
			"100"	1186
Adjustable non-rebated door frame (adjustable square section side)	2042	3042	"60"	811
			"70"	911
			"80N"	987
			"80"	1011
			"90"	1111
Reverse door frame (adjustable square side)	2064	3064	"60"	834
			"70"	934
			"80N"	1010
			"80"	1034
			"90"	1134
			"100"	1234
			"110"	1334
<b>TOP PANEL (1000 x S1) <sup>1)</sup></b>				

FRONT DOOR (panels on the staircase side door opening inwards)											
Frame type	H1	H3	Width	S1	S3						
Adjustable HERSE door frame (adjustable square section side)	2029	3029	"80"	986	1106	1156	1206	1226	1326	1426	
			"90E"	1090	1210	1260	1310	1330	1430	1530	
			"100"	1186	1306	1356	1406	1426	1526	1626	
HERSE fixed door frame "clip-on"	2062	3062	"80N"	1012	1132	1182	1232	1252	1352	1452	
			"80"	1052	1172	1222	1272	1292	1392	1492	
			"90E"	1156	1276	1326	1376	1396	1496	1596	
FORTECA fixed "clip-on" door frame	2068	3068	"80N"	1012	1132	1182	1232	1252	1352	1452	
			"80"	1056	1176	1226	1276	1296	1396	1496	
			"90E"	1156	1276	1326	1376	1396	1496	1596	
FORTECA fixed frame with adjustment (installation side)	2057	3057	"80N"	990	1110	1160	1210	1230	1330	1430	
			"80"	1034	1154	1204	1254	1274	1374	1474	
			"90E"	1134	1254	1304	1354	1374	1474	1574	
LEDA, HYPERION fixed door frame "clip-on"	2068	3068	"80"	1085	1205	1255	1305	1325	1425	1525	
			"90E"	1185	1305	1355	1405	1425	1525	1625	
			"100"	1285	1405	1455	1505	1525	1625	1725	
			"110" <sup>4)</sup>	1385 <sup>4)</sup>	1505 <sup>4)</sup>	1555 <sup>4)</sup>	1605 <sup>4)</sup>	1625 <sup>4)</sup>	1725 <sup>4)</sup>	1825 <sup>4)</sup>	
LEDA, HYPERION adjustable fixed frame (installation side)	2057	3057	"80"	1063	1183	1233	1283	1303	1403	1503	
			"90E"	1163	1283	1333	1383	1403	1503	1603	
			"100"	1263	1383	1433	1483	1503	1603	1703	
			"110" <sup>4)</sup>	1363 <sup>4)</sup>	1483 <sup>4)</sup>	1533 <sup>4)</sup>	1583 <sup>4)</sup>	1603 <sup>4)</sup>	1703 <sup>4)</sup>	1803 <sup>4)</sup>	

PANEL 200	PANEL 250	PANEL 300	2x PANEL 200	2x PANEL 250	2x PANEL 300
SINGLE-FACE SIDE PANEL			DOUBLE-FACE SIDE PANEL		

DOOR FRAME EXTENSION PANELS <sup>3)</sup> – price per m <sup>2</sup>	
GREKO	
CPL 0.2, ST CPL and PREMIUM	
PAINTED	

<sup>1)</sup> the grain direction in the top panel up to a panel width of S1 ≤ 1050 mm can be chosen as horizontal or vertical, while above S1 > 1050 mm, as horizontal only

<sup>2)</sup> only top panels are available for interior door frames



<sup>3)</sup> the panels shall be edged on all four edges in a colour similar to that of the panel surface. The area is calculated from the tables above.

<sup>4)</sup> valid for LEDA doors only

# SLIDING SYSTEMS

## WALL-MOUNTED

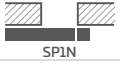
### WALL-MOUNTED SLIDING DOOR SYSTEM:

<b>SINGLE SP1Nz (with bolt keeper)</b>	
<b>SINGLE SP1Nb (w/o bolt keeper)</b>	
<b>DOUBLE SP2N</b>	

Price includes:

Aluminium track with a cover profile and door stop in the colour of the door leaf and length:

- 210 cm for "100" leaves
- 200 cm for "90" leaves
- 180 cm for "80" leaves
- 150 cm for "70" "60" leaves

#### Available wall-mounted sliding system sets

- track with a cover profile and door stop with gasket (only SP1Nz & SP1Nb)
- track with a cover profile and tunnel door frame (only for SP2N)
- track with a cover profile and door stop + tunnel door frame (only SP1Nz & SP1Nb)
- track with a cover profile and door stop with gasket + tunnel door frame (only SP1Nz & SP1Nb)

The SP1N and SP2N wall-mounted sliding door system with selected door leaves is also available as per the PL2112 standard.

The non-rebated door leaf for wall-mounted sliding system cannot have an air gap undercut. The cover profile is neither laminated nor paint coated on the inside.

### EXTRA CHARGES

#### "tunnel" type adjustable door frame

included in the price of the adjustable frame

#### hook bolt lock with hardware<sup>2)</sup>

only for the single door system

#### oval, rectangular or round pull handle

glossy chrome, brushed chrome, glossy brass, black matt; two pcs. of pull handles per set

#### synchronisation

simultaneous opening and closing of the door leaves using only one leaf; only for SP2N

#### crossheads and pilasters

#### damper<sup>3)</sup>

automatic leaf damping during the final closing phase

only for SP1Nz and SP1Nb

#### standard 2112

surcharge for door leaves under standard 2112 and as the "tunnel" version

### ROUND, OVAL AND RECTANGULAR PULL HANDLES<sup>1)</sup>

Glossy chrome, brushed chrome, glossy brass, black matt



<sup>1)</sup> in the BALDUR 8 model, the oval and square pull handles overlap the moulding

### HOOK BOLT KEY LOCKS

glossy chrome,  
brushed chrome,  
glossy brass,  
matt black

Key only in silver



The hook bolt key lock comes with two pull handles to choose

<sup>2)</sup> NOTE: the height of the oval pull handle for the key / toilet door variant varies and is: key: 1006 mm, toilet option: 1015 mm (measured from the bottom edge of the leaf)

<sup>3)</sup> apply only on single side

# WALL-MOUNTED SLIDING DOOR SYSTEM

## WITH DOOR OPENING HOUSING

SP1Nz or SP1Nb (left, obverse version)

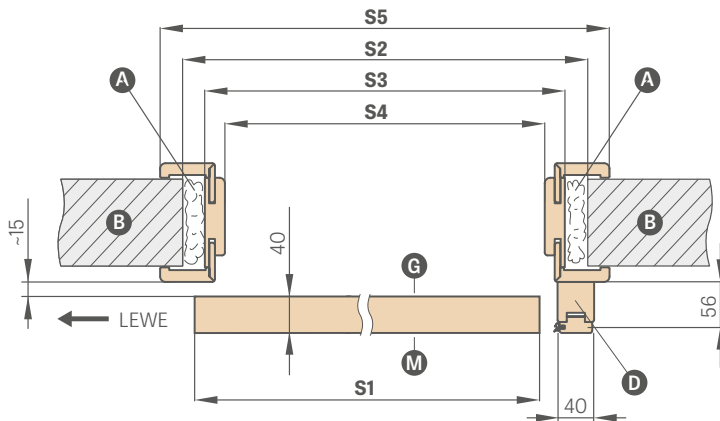

SP2N (obverse version)

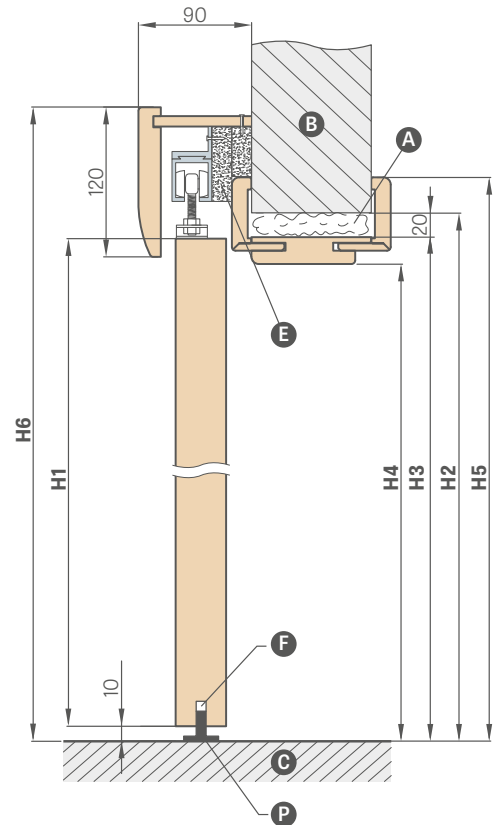
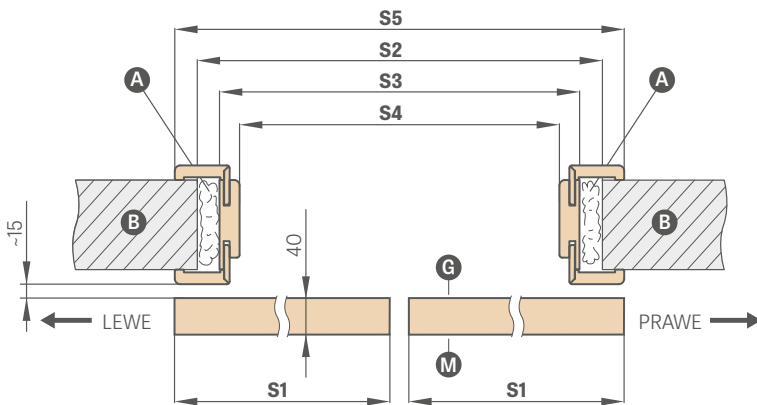

- A - foam
- B - wall
- C - floor
- D - door stop (directional as per the PL2112 standard)
- E - spacer strip
- F - milled groove for the guide rail
- G - smooth side of the glass
- M - Glass matte side
- P - floor guide rail

WALL-MOUNTED SLIDING DOOR SYSTEM WITH DOOR OPENING HOUSING

		SINGLE DOORS					DOUBLE DOORS				
		"60"	"70"	"80"	"90"	"100"	"60" x 2	"70" x 2	"80" x 2	"90" x 2	"100" x 2
S1	Door leaf width	644	744	844	944	1044	1288	1488	1688	1888	2088
S2	Opening width in the wall	688	788	888	988	1088	1288	1488	1688	1888	2088
S3	Frame outer width	648	748	848	948	1048	1248	1448	1648	1848	2048
S4	Frame opening width	604	704	804	904	1004	1204	1404	1604	1804	2004
S4	Opening width in the wall for SPN w/o housing	604	704	804	904	1004	1204	1404	1604	1804	2004
S5	Frame cover width architrave 6 cm /architrave 8 cm	746 / 786	846 / 886	946 / 986	1046 / 1086	1146 / 1186	1346 / 1386	1546 / 1586	1746 / 1786	1946 / 1986	2146 / NA
H1	Door leaf height	2030 (2112) <sup>1)</sup>									
H2	Opening height in the wall	2060 (2142) <sup>1)</sup>									
H2	Opening height in the wall for SPN w/o housing	2020 (2102) <sup>1)</sup>									
H3	Frame outer height	2040 (2122) <sup>1)</sup>									
H4	Frame opening height	2018 (2100) <sup>1)</sup>									
H5	Frame cover height architraves 6 cm /architraves 8 cm	2089 / 2109 (2171 / 2191) <sup>1)</sup>									2089 / none (2171 / 2191) <sup>1)</sup>
H6	Overall system height	2142 (2224) <sup>1)</sup>									

<sup>1)</sup> PL2112 standard

# WALL-MOUNTED SLIDING DOOR SYSTEM

## LOFT STANDARD TYPE



Leaf BALDUR 7, WHITE TITAN UV facing layer, black rectangular pull handles, INDUSTRIAL door hangers

The LOFT STANDARD single sliding system is available with all leaves in the SP1N standard wall mounted sliding system.

Double sliding system LOFT STANDARD consists of two single door systems and a connecting element for rails.

Double LOFT STANDARD system is counted as 2 x single door system + connecting element for rails. Three door hangers to choose from: INDUSTRIAL, RETRO and ART (p. 145).

### LOFT STANDARD sliding door system

oval, rectangular or round pull handle<sup>3)</sup>

door closer on one side

connector for tracks (enables the use of the LOFT system in the double door system)

Standard 2112 – surcharge for doors under Standard 2112

+ 15%

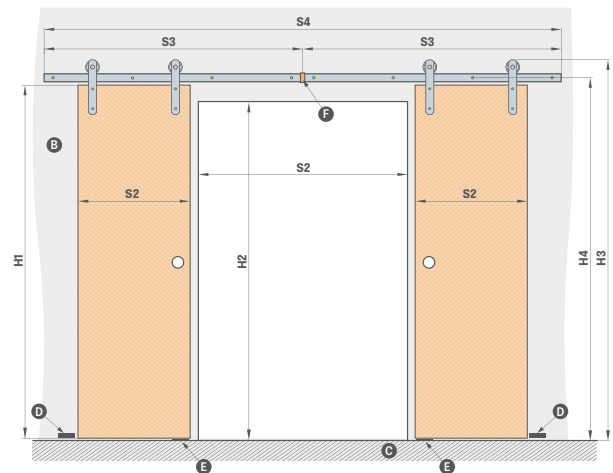
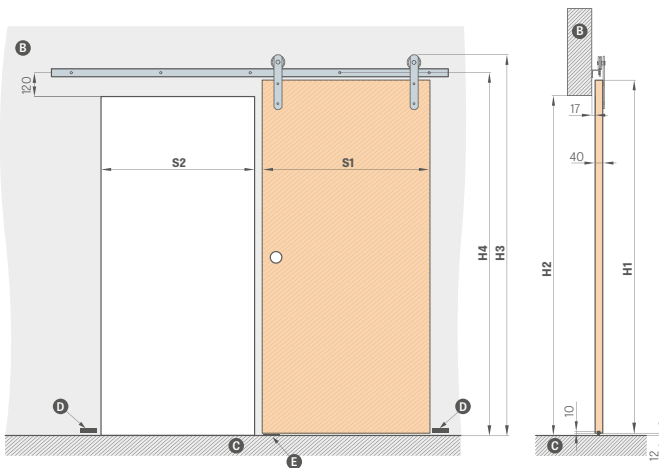

	"60"	"70"	"80"	"90"	"100"	
S1	Door leaf width	644	744	844	944	1044
S2	Opening width in the wall <sup>1)</sup>	574	674	774	874	974
H1	Door leaf height	2030	2030	2030	2030	2030
H2	Opening height in the wall	1962	1962	1962	1962	1962
H3	Overall system height	2170	2170	2170	2170	2170
H4	Height to mounting holes in running rail	2082	2082	2082	2082	2082

### GUIDE RAIL FOR SINGLE DOOR SYSTEM LENGTH:

- 200 cm for "60" "70" "80" leaves

- 250 cm for "90" "100" leaves

	"120"	"140"	"160"	"180"	"200"	
S1	Door leaf width	2 x 644	2 x 744	2 x 844	2 x 944	2 x 1044
S2	Opening width in the wall <sup>1)</sup>	1202	1402	1602	1802	2002
S3	Guide width	2000	2000	2000	2500	2500
S4	Total guide width <sup>2)</sup>	4000	4000	4000	5000	5000
H1	Door leaf height	2030	2030	2030	2030	2030
H2	Opening height in the wall	1962	1962	1962	1962	1962
H3	Overall system height	2170	2170	2170	2170	2170
H4	Height to mounting holes in running rail	2082	2082	2082	2082	2082

**B** – wall **C** – floor **D** – wall mounted buffer  
**E** – guide **F** – guide connector<sup>2)</sup>

<sup>1)</sup> the leaf in the closed position overlaps 35 mm on each side

<sup>2)</sup> a guide for double door system consists of two guides connected with a connector

<sup>3)</sup> in the BALDUR 8 model, the oval and square pull handles overlap the moulding

# WALL-MOUNTED SLIDING DOOR SYSTEM

## LOFT Type



LOFT door leaf, OAK ST CPL facing layer, round pull handle, RETRO door hangers

LOFT Type wall-mounted sliding door system is available in black and incorporates the LOFT Type solid core door leaf. The LOFT door leaf comes with a rigid honeycomb infill as standard or solid core panel for extra charge. The door leaf features a non-rebated edge. The system is designed for clear finished opening, without a tunnel.

The complete system includes the sliding LOFT system + LOFT door leaf + pull handle + door closer on one or both side(s).

The LOFT double door system is counted as 2 x single door system + connecting rail element.

Three door hangers to choose from: INDUSTRIAL, RETRO and ART.

### LOFT sliding door system

oval, rectangular or round pull handle

solid core filling

round and square metal ventilation sleeves (4 pieces); black matt

door closer on one side

connector for tracks (enables the use of the LOFT system in the double door system)

black door leaf edge finish

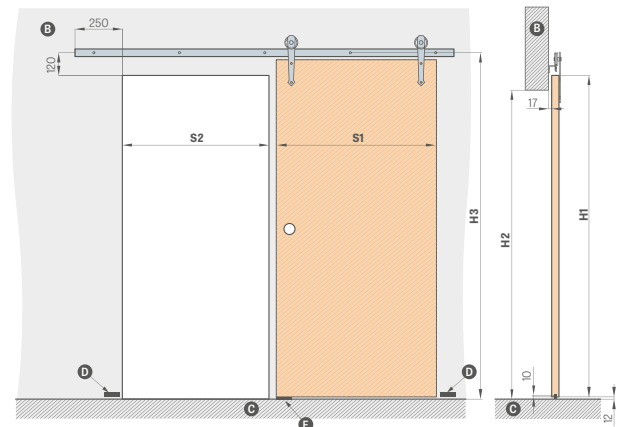

	"60"	"70"	"80"	"90"	"100"
S1 Door leaf width	644	744	844	944	1044
S2 Opening width in the wall	574	674	774	874	974
H1 Door leaf height	2150	2150	2150	2150	2150
H2 Opening height in the wall	2082	2082	2082	2082	2082
H3 Height to mounting holes in running rail	2202	2202	2202	2202	2202

B- wall C- floor D- wall-mounted buffer E- guide

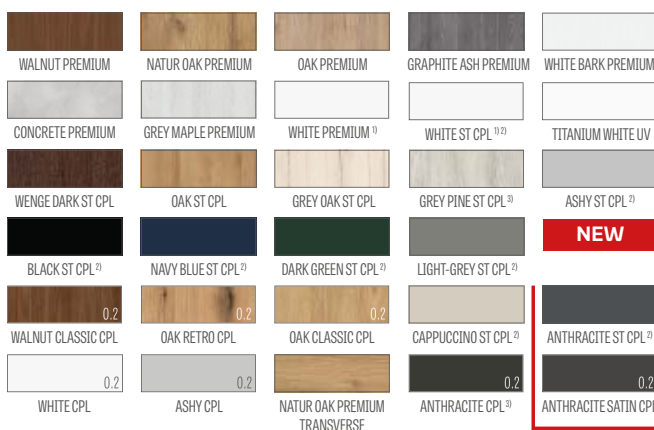

<sup>1)</sup> plain white facing imitating a painted surface

<sup>2)</sup> special **AntiFinger** **NEW** coating to reduce dirt and fingerprints

<sup>3)</sup> until stock lasts

### ROUND, OVAL, RECTANGULAR PULL HANDLES

glossy chrome, brushed chrome, glossy brass, black matt



### GUIDE RAIL LENGTHS:

- 200 cm for "60" "70" "80" leaves

- 250 cm for "90" "100" leaves

### DOOR HANGERS



BLACK PLAIN DOOR LEAF EDGE FINISH



BLACK HORIZONTAL DOOR LEAF EDGE FINISH

# WALL-MOUNTED SLIDING DOOR SYSTEM

## MAGIC Type



MAGIC door leaf, OAK PREMIUM facing layer, oval pull handle

MAGIC Type wall-mounted sliding door system incorporates the MAGIC Type solid core door leaf only. The MAGIC door leaf comes with a rigid honeycomb infill as standard or solid core panel for extra charge. The door leaf features a non-rebated edge. The system is designed for clear finished opening, without a tunnel. The complete system includes the sliding MAGIC system + MAGIC door leaf + pull handle. The system is only available as a complete set (system + leaf).

### MAGIC SLIDING DOOR SYSTEM

oval, rectangular or round pull handle

solid core filling

round and square metal sleeves (4 pcs);  
glossy chrome, brushed chrome, black matt

black door leaf edge finish

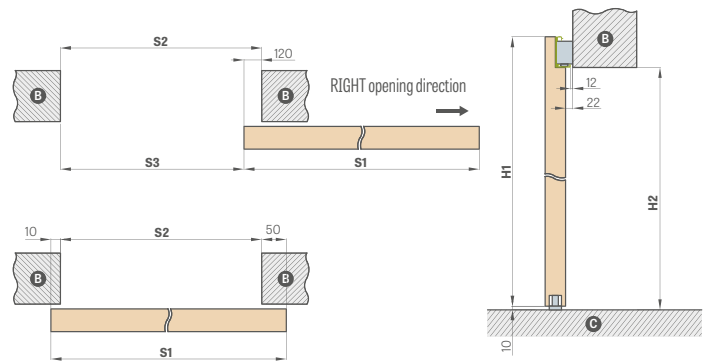

MAGIC WALL-MOUNTED SLIDING DOOR SYSTEM		"60"	"70"	"80"	"90"	"100"
S1	Door leaf width	644	744	844	944	1044
S2	Opening width in the wall	584	684	784	884	984
S3	Transition light	464	564	664	764	864
H1	Door leaf height	2150	2150	2150	2150	2150
H2	Opening height in the wall	2100	2100	2100	2100	2100

B - wall C - floor

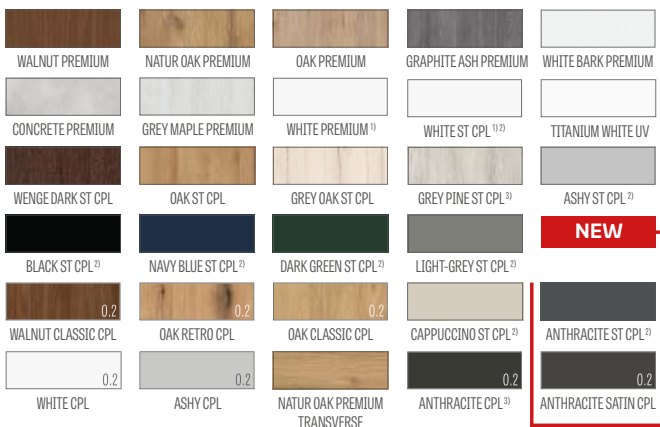

### ROUND, OVAL, RECTANGULAR PULL HANDLES

Glossy chrome, brushed chrome, glossy brass, black matt



BLACK PLAIN DOOR LEAF EDGE FINISH



BLACK HORIZONTAL DOOR LEAF EDGE FINISH

<sup>1)</sup> plain white facing imitating a painted surface

<sup>2)</sup> special **AntiFinger** **NEW** coating to reduce dirt and fingerprints

<sup>3)</sup> until stock lasts

# WALL-MOUNTED SLIDING DOOR SYSTEM

## GRAF GLASS DOORS



GRAF 61 SYSTEM

Sliding system for glass doors with a silver anodised aluminium or back matt powder-painted cover.

This system is complete and designed for fitting in a clear finished opening, as the tunnel is not available. The system range includes all GRAF glass panes, see pp. 60-61 and go to our website: [www.erkado.pl](http://www.erkado.pl) and the B2B panel.

The complete system includes: sliding SYSTEM GRAF + glass pane SYSTEM GRAF + pull handle + door closer on one side

### GLASS DOOR SLIDING SYSTEM

- silver anode
- matt black

glass pane

double-sided round pull handle, stainless steel

double-sided round pull handle, stainless steel, black matt

double-sided round pull handle, anodised aluminium in stainless steel or black matt (powder-coated)

"90" glass pane extra charge

door closer

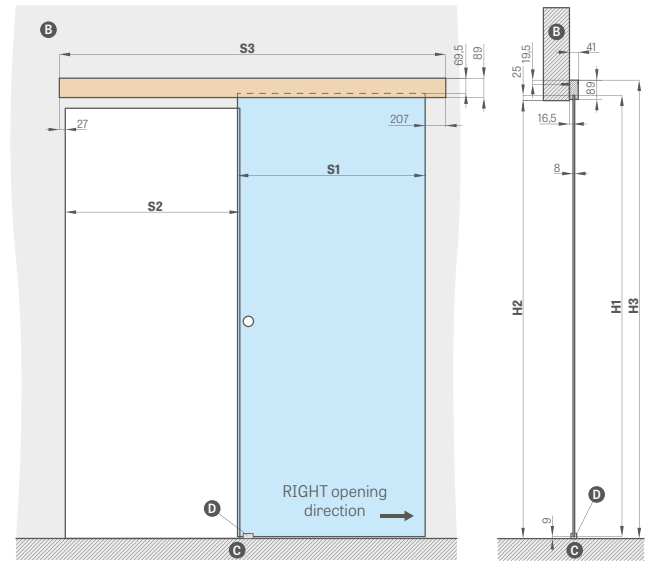

**B** - wall   **C** - floor   **D** - guide shoe

### PULL HANDLE



stainless steel, matt black (external diameter 54 mm)







anodised aluminium inox, matt black powder-coated (external diameter 65 mm)

WALL-MOUNTED GLASS DOOR SLIDING SYSTEM					
		"60"	"70"	"80"	"90"
S1	Door leaf width	662	762	862	962
S2	Opening width in the wall	602	702	802	902
S3	Guide rail length	1500	1500	1800	2000
H1	Door leaf height	2036			
H2	Opening height in the wall	max 2020			
H3	Overall system height	2114			

# SLIDING SYSTEMS

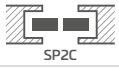
## POCKET SYSTEMS

ERKADO pocket door system range includes:

BASIC TUNNEL INSTALLATION		
SP1C.100		Single "100" pocket sliding system only available for STILE panelled doors, painted doors and ALTAMURA 1, UNO PREMIUM and UNO LUX models
SP2C.100		Double "100" pocket sliding system only available for STILE panelled doors and ALTAMURA 1 and UNO PREMIUM models
SP1C.125		Single "125" pocket sliding system
SP2C.125		Double "125" pocket sliding system
ZN1		One-sided supplementary basic in-wall installation for SP1C.100 or SP1C.125 system
ZN2		One-sided supplementary basic in-wall installation for SP2C.100 or SP2C.125 system

Not available for CPL0.2 & CPL0.7 laminates

$$\text{SLIDING SYSTEM PRICE} = \text{DOOR LEAF PRICE} + \text{ALUMINIUM POCKET PRICE} + \text{BASIC TUNNEL INSTALLATION PRICE} + \text{OPTIONAL INSTALLATION PRICE ZN1 OR ZN2}$$

Standard single/double pocket sliding system includes:

- aluminium case [LEON] SP1
- aluminium case [LEON] SP2
- non-rebated door leaf / two non-rebated door leaves – price for standard door leaf / price for two door leaves
- basic tunnel installation (see table above)
- tunnel installation ZN1 or ZN 2 – see table on the next page

### ROUND, OVAL AND RECTANGULAR PULL HANDLES <sup>1)</sup>

glossy chrome, brushed chrome, glossy brass, black matt



### HOOK BOLT KEY LOCKS

glossy chrome,  
brushed chrome,  
glossy brass,  
matt black

Key only in silver



The hook bolt key lock comes with two pull handles to choose

### EXTRA CHARGES

frame joints at 90 degrees

#### hook bolt lock with hardware <sup>2)</sup>

only available for: SP1C.100, SP1C.125

#### oval, rectangular or round pull handle

glossy chrome, brushed chrome, glossy brass, black matt  
available for SP1C.100, SP2C.100, SP1C.125, SP2C.125  
pull handle set includes two pcs.

#### finger pull

glossy chrome, brushed chrome, glossy brass, black matt

#### synchronisation

simultaneous opening and closing of the door leaves using only one leaf  
only available for: SP2C.100, SP2C.125

#### crossheads and pilasters

#### damper <sup>3)</sup>

automatic soft close in the final closing phase; available for SP1C.100, SP1C.125 only

#### standard 2112

surcharge for door leaves under standard 2112, pockets and housings

<sup>1)</sup> in the BALDUR 8 model, the oval and square pull handles overlap the moulding

<sup>2)</sup> NOTE: the height of the oval pull handle for the key / toilet door variant varies and is:  
key: 1006 mm, toilet option: 1015 mm (measured from the bottom edge of the leaf)

<sup>3)</sup> apply only on single side

One-sided adjustment range for the basic wall min-max (mm)	IN-WALL INSTALLATION IN THE SINGLE LEAF SYSTEM FOR ONE SIDE ZN1		
	GREKO	PREMIUM & ST CPL	TITANIUM WHITE UV <b>NEW</b>
0-40; 40-60; 60-80;			
80-100; 100-120; 120-140			
140-160; 160-180; 180-200			
200-220; 220-240			
240-260; 260-280			
280-300; 300-320			
320-340; 340-360			

- the system of one-sided in-wall installation for double doors ZN2 + 30% extra of the prices in table above
- surcharge of 15% for Standard 2112

		SINGLE & DOUBLE POCKET SLIDING SYSTEMS									
		"60"	"70"	"80"	"90"	"100"	2 x "60"	2 x "70"	2 x "80"	2 x "90"	2 x "100"
<b>S1</b>	Door leaf width	644	744	844	944	1044	1288	1488	1688	1888	2088
<b>S2</b>	Frame opening width	604	704	804	904	1004	1204	1404	1604	1804	2004
<b>S3</b>	Pocket width	1318	1518	1718	1918	2118	2538	2938	3338	3738	4138
<b>S4</b>	Frame cover width architrave 6 cm /architrave 8 cm	746 / 786	846 / 886	946 / 986	1046 / 1086	1146 / 1186	1346 / 1386	1546 / 1586	1746 / 1786	1946 / 1986	2146 / NA
<b>S5</b>	Opening width in the pocket	655	755	855	955	1055	1255	1455	1655	1855	2055
<b>S6</b>	Opening width in the wall	1338	1538	1738	1938	2138	2558	2958	3358	3758	4158
<b>H1</b>	Door leaf height	2030 (2112) <sup>1)</sup>									
<b>H2</b>	Frame cover height architraves 6 cm /architraves 8 cm	2092 / 2112 (2174 / 2194) <sup>1)</sup>									2092 / none (2174 / none) <sup>1)</sup>
<b>H3</b>	Pocket height	2115 (2197) <sup>1)</sup>									
<b>H4</b>	Frame opening height	2021 (2103) <sup>1)</sup>									
<b>H5</b>	Opening height in the wall	2125 (2207) <sup>1)</sup>									

<sup>1)</sup> PL2112 standard



Photo: Wall-mounted sliding system



Photo: Pocket sliding system

# SINGLE AND DOUBLE DOOR SYSTEMS

## POCKET SYSTEMS

### SPIC.100 (left, AWERS obverse glazing)

#### Fixed range of 100 mm

Pocket thickness before gypsum board installation – 75 mm

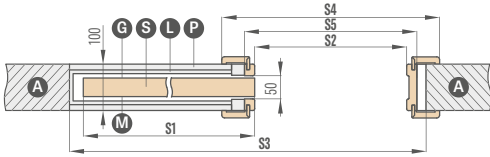

For UNO PREMIUM, ALTAMURA 1 only, and for all panelled doors.  
The system does not come with dust brushes (not required).

### SPIC.125 (left, AWERS obverse glazing)

#### Fixed range of 125 mm

Pocket thickness before gypsum board installation – 100 mm

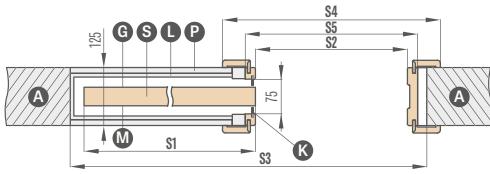

Only for use with flush doors which are supplied with a glass frame.  
The system includes grey dust brushes.

### ZN1 one-sided basic in-wall installation for SPIC.100 and SPIC.125

Basic in-wall installation range from 0-40; 40-60; ... 340-360

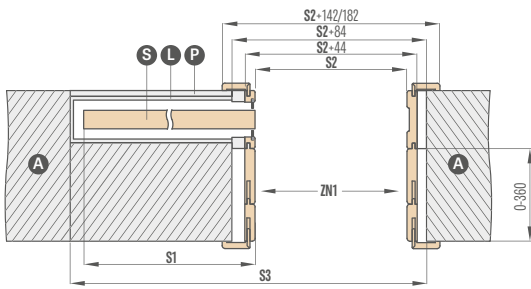

The drawing shows a one-sided the basic in-wall installation ZN1.

### SP2C.100 (AWERS obverse glazing)

#### Fixed range of 100 mm

Pocket thickness before gypsum board installation – 75 mm

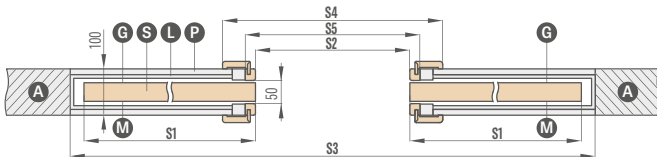

For UNO PREMIUM, ALTAMURA 1 only, and for all panelled doors.  
The system does not come with dust brushes (not required).

### SP2C.125 (AWERS obverse glazing)

#### Fixed range of 125 mm

Pocket thickness before gypsum board installation – 100 mm

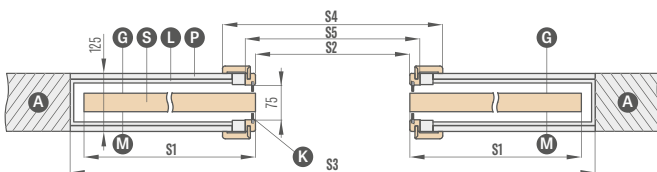

Only for use with flush doors which are supplied with a glass frame.  
The system includes grey dust brushes.

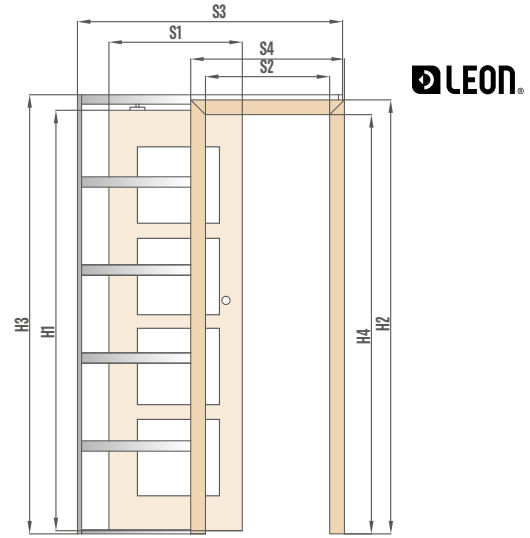

LEON®

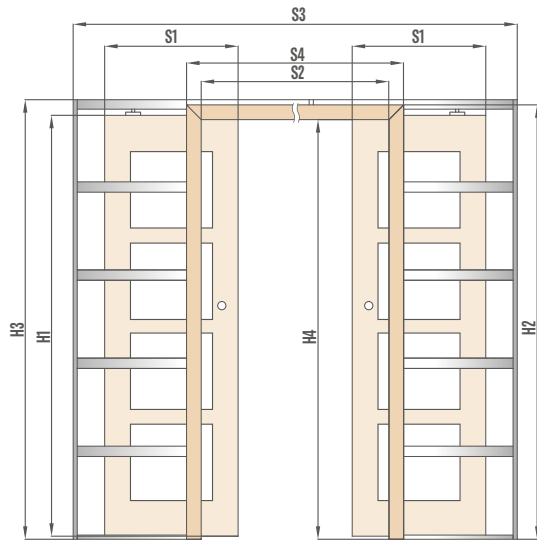

- A** – wall
- L** – aluminium case
- P** – gypsum board
- K** – dust brushes
- G** – smooth smooth side of the glass
- M** – glass matt side
- S** – door leaf

### ZN2 one-sided basic in-wall installation for SP2C.100 and SP2C.125

Basic in-wall installation range from 0-40; 40-60; ... 340-360

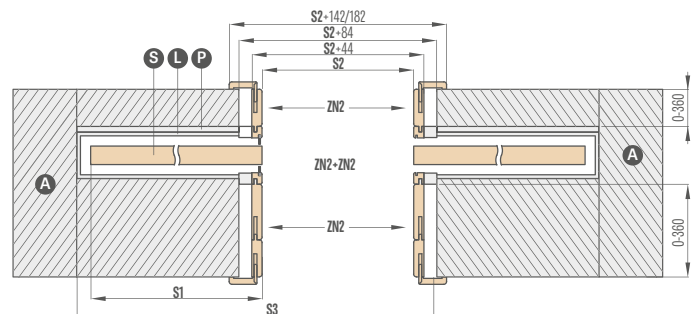

The drawing shows double-sided the basic in-wall installation ZN2 + ZN2.

# DOUBLE DOORS

## REBATED AND NON-REBATED

### USEFUL INFORMATION

#### DOUBLE DOORS



- The double doors are supplied with a solid core infill for extra charge.
- The double doors are made according to available models of the flush single doors, STILE panelled doors with respective features: colour, finish (STANDARD, SOFT), glazing etc.
- Double doors available in CPL 0.2 & CPL 0.7
- Passive doors use pull latches.
- Under "60" width passive door available as a solid core, plain version only – side panel (see drawing below).
- Side panels are made in the STANDARD edge flush technology. Available with a honeycomb infill as standard or solid core panel for extra charge. Grain direction of the side panels is vertical.
- Both active and inactive door leaves come with lippings.
- Lippings in CPL 0.7 door leaves are laminated with CPL 0.2
- The double doors in non-rebated technology are available with a magnetic lock only.
- Double non-rebated leaf doors come with an adjustable door frame only.
- Electric door strike is not available for the double doors.
- PL2112 Standard for selected door leaves

### AVAILABLE DOOR LEAF WIDTHS

- flush and panelled DOUBLE DOORS from "120" to "190"\*\*\* and mixes with solid core, plain side panels

60 + 30*	70 + 30*	80 + 30*	90 + 30*	100 + 30*
60 + 40*	70 + 40*	80 + 40*	90 + 40*	100 + 40*
60 + 50*	70 + 50*	80 + 50*	90 + 50*	100 + 50*

- \* side panel available in standard technology only as a solid core, plain version
- \*\* for "180" non-rebated doors

### DOUBLE DOOR PRICE:

- flush and panelled: active leaf **60 70 80 90 100** + passive leaf **60 70 80 90\***

$$\text{price of double doors with lipping} = \text{Door leaf price x 2} + \text{Lippings}$$

- flush and panelled: active leaf **60 70 80 90 100** + solid core, plain passive side panels **30 40 50**

$$\text{price of double doors with side panel and lipping} = \text{Door leaf price} + \text{Full side panel with lippings}$$

- prices of fixed and adjustable door frames for double doors + 30%
- extra charge for solid core in a side panel
- painted extension only solid core WHITE TITANIUM UV

\* not in the non-rebated door leaves

# DOUBLE DOORS

## NON-REBATED

### NON-REBATED DOUBLE DOORS WITH ADJUSTABLE DOOR FRAME

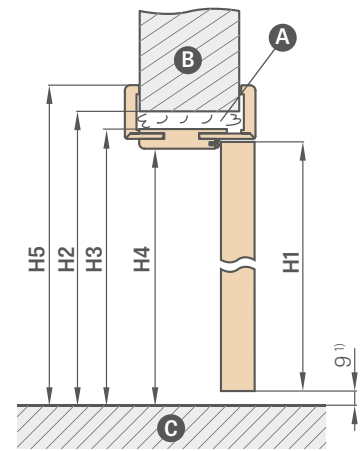
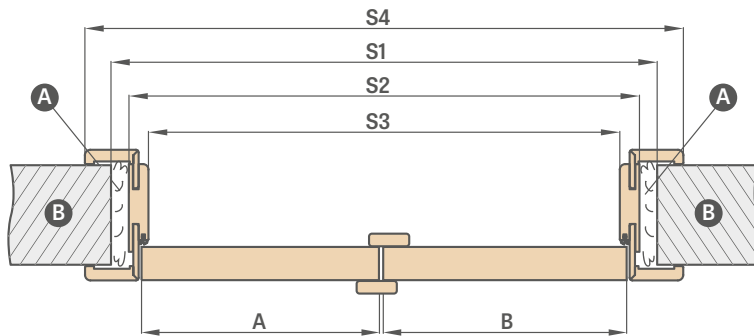

Ⓐ-foam Ⓑ-wall Ⓒ- floor

<sup>1)</sup> allowable deviation due to frame dimensional tolerance of +- 3mm (we recommend to check before installation)

Adjustable door frame		NON-REBATED DOUBLE DOORS									
		"90"	"100"	"110"	"120"	"130"	"140"	"150"	"160"	"170"	"180"
<b>A+B</b>	Door leaf width	988	1088	1188	1288	1388	1488	1588	1688	1788	1888
<b>S1</b>	Opening width in the wall	1061	1161	1261	1361	1461	1561	1661	1761	1861	1961
<b>S2</b>	Frame outer width	1021	1121	1221	1321	1421	1521	1621	1721	1821	1921
<b>S3</b>	Frame opening width	977	1077	1177	1277	1377	1477	1577	1677	1777	1877
<b>S4</b>	Frame cover width architrave 6 cm /architrave 8 cm	1119/ 1159	1219/ 1259	1319/ 1359	1419/ 1459	1519/ 1559	1619/ 1659	1719/ 1759	1819/ 1859	1919/ 1959	2019/ 2059
<b>H1</b>	Door leaf height	2030 (2112) <sup>2)</sup>									
<b>H2</b>	Opening height in the wall	2073 (2155) <sup>2)</sup>									
<b>H3</b>	Frame outer height	2053 (2135) <sup>2)</sup>									
<b>H4</b>	Frame opening height	2031 (2113) <sup>2)</sup>									
<b>H5</b>	Frame cover height architraves 6 cm /architraves 8 cm	2102 / 2122 (2184 / 2204) <sup>2)</sup>									

DOUBLE-LEAF DOORS  
- SYMMETRIC



DOUBLE-LEAF DOORS  
- ASYMMETRIC



DOUBLE-LEAF DOORS  
- WITH PLAIN SIDE PANEL



<sup>2)</sup> PL2112 standard

# DOUBLE DOORS

## REBATED

### REBATED DOUBLE DOORS WITH ADJUSTABLE DOOR FRAME

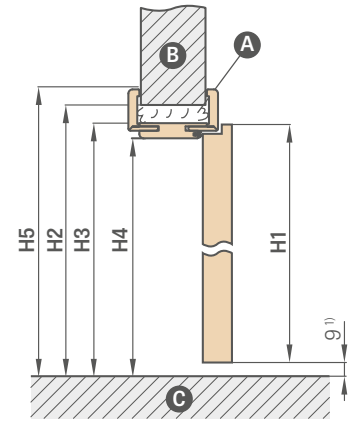
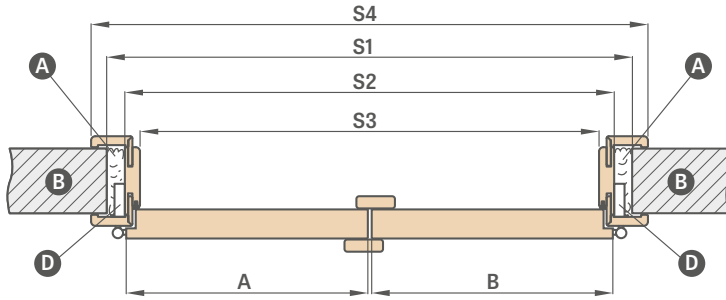

A- foam B- wall C- floor D- hinge socket

Adjustable door frame	DOUBLE DOORS											
	"90"	"100"	"110"	"120"	"130"	"140"	"150"	"160"	"170"	"180"	"190"	
A+B Door leaf width	988	1088	1188	1288	1388	1488	1588	1688	1788	1888	1988	
S1 Opening width in the wall	1034	1134	1234	1334	1434	1534	1634	1734	1834	1934	2034	
S2 Frame outer width	994	1094	1194	1294	1394	1494	1594	1694	1794	1894	1994	
S3 Frame opening width	950	1050	1150	1250	1350	1450	1550	1650	1750	1850	1950	
S4 Frame cover width architrave 6 cm /architrave 8 cm	1092 / 1132	1192 / 1232	1292 / 1332	1392 / 1432	1492 / 1532	1592 / 1632	1692 / 1732	1792 / 1832	1892 / 1932	1992 / 2032	2092 / 2132	
H1 Door leaf height	2030 (2112) <sup>2</sup>											
H2 Opening height in the wall	2060 (2142) <sup>2</sup>											
H3 Frame outer height	2040 (2122) <sup>2</sup>											
H4 Frame opening height	2018 (2100) <sup>2</sup>											
H5 Frame cover height architrave 6 cm /architrave 8 cm	2089 / 2109 (2171 / 2191) <sup>2</sup>											

### REBATED DOUBLE DOORS WITH FIXED DOOR FRAME

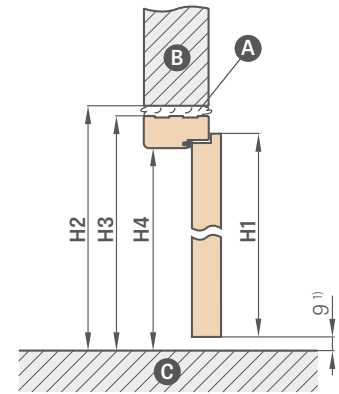
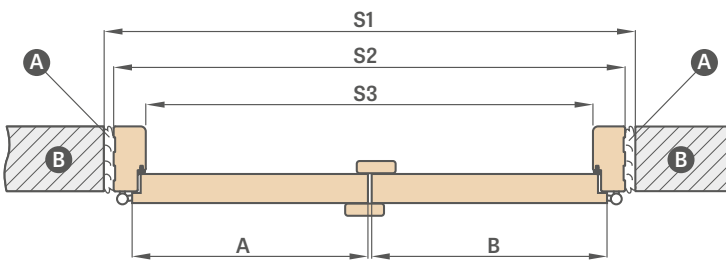

A- foam B- wall C- floor

Fixed door frame	DOUBLE DOORS											
	"90"	"100"	"110"	"120"	"130"	"140"	"150"	"160"	"170"	"180"	"190"	
A+B Door leaf width	988	1088	1188	1288	1388	1488	1588	1688	1788	1888	1988	
S1 Opening width in the wall	1068	1168	1268	1368	1468	1568	1668	1768	1868	1968	2068	
S2 Frame outer width	1038	1138	1238	1338	1438	1538	1638	1738	1838	1938	2038	
S3 Frame opening width	950	1050	1150	1250	1350	1450	1550	1650	1750	1850	1950	
H1 Door leaf height	2030	2030	2030	2030	2030	2030	2030	2030	2030	2030	2030	
H2 Opening height in the wall	2077	2077	2077	2077	2077	2077	2077	2077	2077	2077	2077	
H3 Frame outer height	2062	2062	2062	2062	2062	2062	2062	2062	2062	2062	2062	
H4 Frame opening height	2018	2018	2018	2018	2018	2018	2018	2018	2018	2018	2018	

<sup>1)</sup> allowable deviation due to frame dimensional tolerance of +- 3mm (we recommend to check before installation)

<sup>2)</sup> PL2112 standard

# FOLDING DOORS



## DESIGN

- the door leaf is composed of two parts joined with concealed hinges
- MDF stile covered with two HDF boards or internal timber stiles and rails covered with two HDF boards for PREMIUM and CPL facings
- rigid honeycomb infill or solid core infill for additional charge
- the door frame above 320 mm is composed of two parts, and above 400 mm, of three parts.

## FINISH

- HDF board with a facing layer
- STANDARD leaf edge
- the door edge faced with edging in the same colour as the door leaf plane or optionally in black plain edging (black edging with horizontal grain for the TRANSVERSE NATUR OAK PREMIUM facing)

## HARDWARE

- three concealed hinges between leaves
- concealed guiding system in the top and bottom door sections
- a lever tumbler lock, euro profile cylinder, economy lock or with a thumb turn

## EXTRA CHARGES

solid core filling

"100" door leaf

black door leaf edge finish

CPL 0.2 door leaf

CPL 0.7 door leaf



<sup>1)</sup> plain white facing imitating a painted surface

<sup>2)</sup> special **AntiFinger** coating to reduce dirt and fingerprints

<sup>3)</sup> comes complete with the NATUR OAK PREMIUM door frame

<sup>4)</sup> until stock lasts

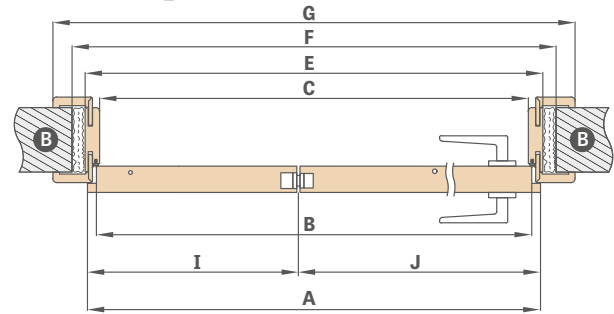
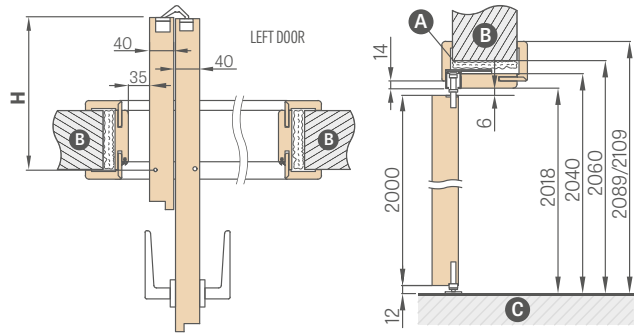

A - foam B - wall C - floor

Door width	A	B	C	E	F	G	H	I	J
"60"	641	614	604	648	688	746* / 786**	152.5	218	418
"70"	741	714	704	748	788	846* / 886**	202.5	268	468
"80"	841	814	804	848	888	946* / 986**	252.5	318	518
"90"	941	914	904	948	988	1046* / 1086**	302.5	368	568
"100"	1041	1014	1004	1048	1088	1146* / 1186**	352.5	418	618

\* Architraves 6 cm / \*\* Architraves 8 cm; joints at 45 degrees only

## AVAILABLE DOOR LEAF WIDTHS

60 70 80 90 100



Installation video  
<https://youtu.be/tzccmzy7rvq>

Adjustment Range min-max (mm)
80-100
100-120
120-140
140-160
160-180
180-200
200-220
220-240

Adjustment Range min-max (mm)
240-260
260-280
280-300
300-340
340-360
360-380
380-400
400-420

Each 2 cm will be charged extra (based on the price range of 400-420 mm) until the range of 500-520 mm

# COVERT CONCEALED DOOR SYSTEM

## OPENING INWARDS AND OUTWARDS



### DESIGN

- rebated or non-rebated door leaf
- wooden stile covered with two HDF boards
- rigid honeycomb infill or solid core infill for additional charge

### FINISH

- HDF board covered with PREMIUM, ST CPL facing, UV paint or a facing layer designed for subsequent paint coating or wallpapering
- door leaf edge made in rebated or non-rebated technology

### HARDWARE

- two mortise hinges in the door frame (third optional, at an extra charge)
- magnetic lock in the rebated and non-rebated leaf: with a key, thumb turn cylinder, economy or with a blockade

### EXTRA CHARGES

white or black door frame <sup>3)</sup>

painted door leaf; WHITE TITANIUM UV

solid core filling

additional bottom rail in the door leaf (can be trimmed by a customer up to max 8 cm)

round and square metal sleeves (4 pcs);  
finish: brushed nickel, patina, white and black

plastic woodgrain sleeves (4 pcs)

enhanced airflow trim, ventilation undercut standard or mini (p. 137) or ventilation grille

third hinge

can be changed to a black magnetic catch in the leaf

can be changed to hinges and catch plate in black

- for two hinges or

- for three hinges

black door leaf edge finish

"100" door leaf

drop down seal <sup>4)</sup>

LUX inlay; available versions pp. 86-91

magnetic stop (buffer) <sup>4)</sup>

(available in six colours p. 137)

Standard 2112 – surcharge for door leaf and frame

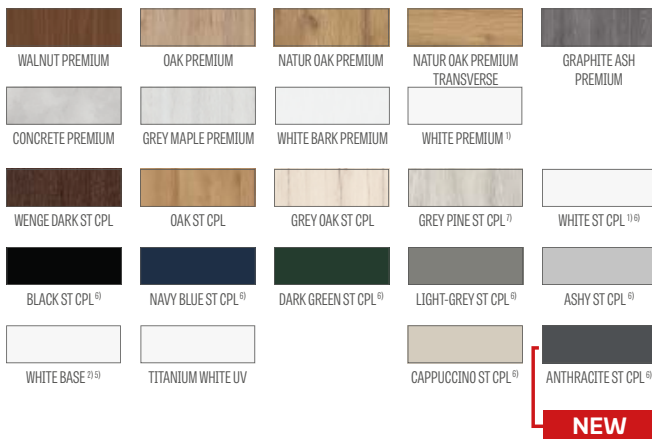

### AVAILABLE DOOR LEAF WIDTHS

60 70<sup>5)</sup> 80<sup>5)</sup> 90 100

<sup>1)</sup> plain white facing imitating a painted surface

<sup>2)</sup> used for wallpaper hanging and painting

<sup>3)</sup> aluminium colour frame as standard

<sup>4)</sup> a stop will not allow a drop down seal, ventilation undercut and an enhanced airflow trim to be used, and vice versa

<sup>5)</sup> WHITE BASE leaves and aluminium door frame width "70" and "80" available on short lead times – ask your dealer for details

<sup>6)</sup> special **AntiFinger** coating to reduce dirt and fingerprints

<sup>7)</sup> until stock lasts

# COVERT CONCEALED DOOR SYSTEM

## INWARDS OPENING REBATED DOOR LEAF

### STANDARD DIMENSIONS FOR INWARDS OPENING REBATED DOOR LEAVES

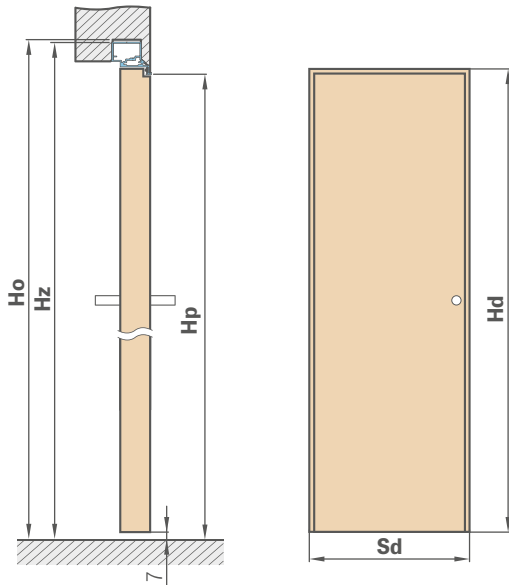

Door leaf width	Construction opening width	Frame outer width	Clear opening width
Sd [mm]	So [mm]	Sz [mm]	Sp [mm]
620	700	690	605
720	800	790	705
820	900	890	805
920	1000	990	905
1020	1100	1090	1005

Door leaf height	Construction opening height	Frame outer height	Clear opening height
Hd [mm]	Ho [mm]	Hz [mm]	Hp [mm]
2030 (2112) <sup>1)</sup>	2079 (2162) <sup>1)</sup>	2072 (2154) <sup>1)</sup>	2030 (2112) <sup>1)</sup>

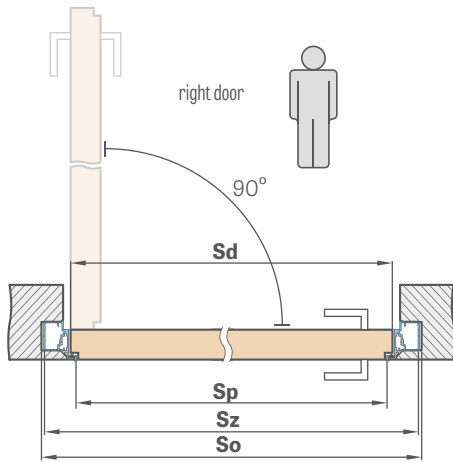

### Gypsum board installation

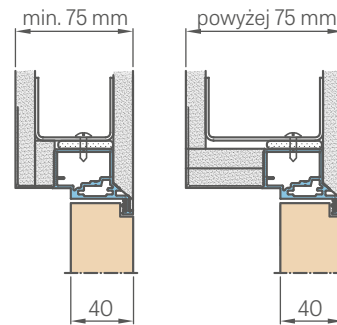

### ALUMINIUM DOOR FRAME CROSS-SECTION

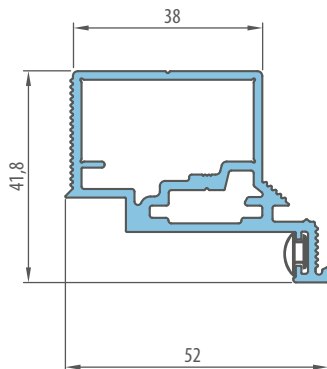

### ENCLOSED IN WALL

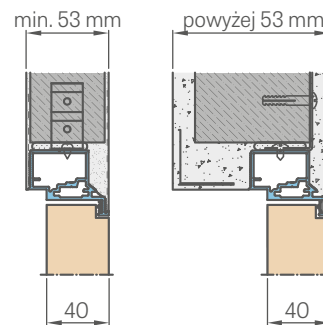

<sup>1)</sup> PL2112 standard

# COVERT CONCEALED DOOR SYSTEM

## OUTWARDS OPENING NON-REBATED DOOR LEAF

### STANDARD DIMENSIONS FOR OUTWARDS OPENING NON-REBATED DOOR LEAVES

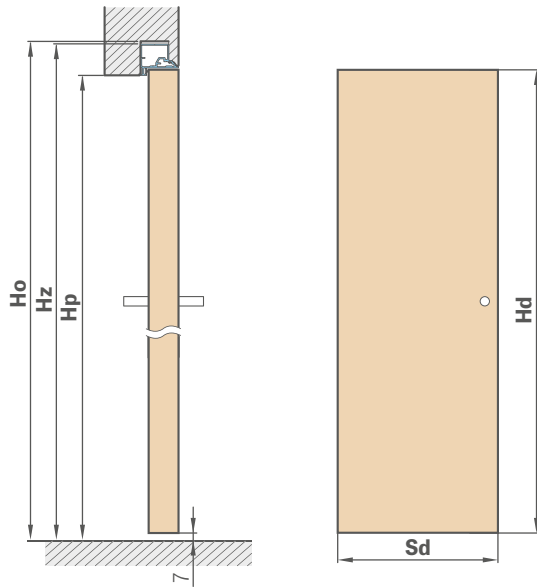

Door leaf width	Construction opening width	Frame outer width	Clear opening width
Sd [mm]	So [mm]	Sz [mm]	Sp [mm]
620	700	690	605
720	800	790	705
820	900	890	805
920	1000	990	905
1020	1100	1090	1005

Door leaf height	Construction opening height	Frame outer height	Clear opening height
Hd [mm]	Ho [mm]	Hz [mm]	Hp [mm]
2020 (2102) <sup>1)</sup>	2069 (2152) <sup>1)</sup>	2062 (2144) <sup>1)</sup>	2020 (2102) <sup>1)</sup>

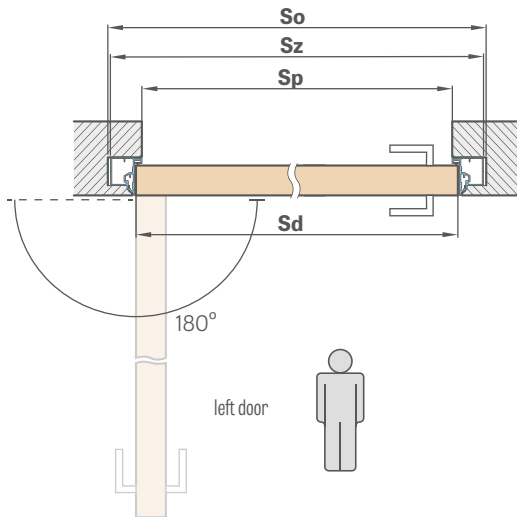

### Gypsum board installation

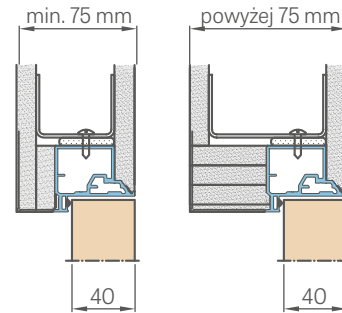

### ALUMINIUM DOOR FRAME CROSS-SECTION

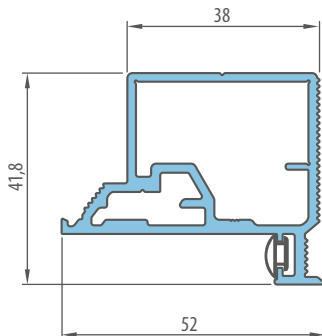

### ENCLOSED IN WALL

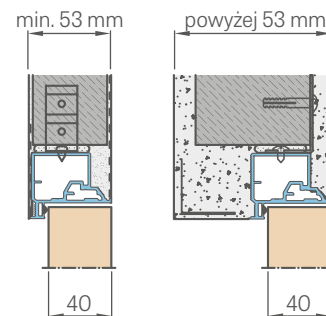

<sup>1)</sup> PL2112 standard

# SIDELIGHTS FOR DOORS

## REBATED

### GENERAL INFORMATION

The top and side lights are preassembled and glazed with the VSG 331 safety glass in a frosted or clear variant. (Please state your choice of glass when placing orders).

Additional components (e.g. wooden posts) may be required to integrate the side/top lights to the door, or more precisely to the adjustable or fixed frame, which the installer selects and supplies according to the existing opening conditions. ERKADO does not sell these items.

### LIGHTING CATEGORIES

FOR FIXED DOOR FRAMES
FOR ADJUSTABLE DOOR FRAMES
FOR SINGLE LEAF DOORS
FOR DOUBLE-LEAF DOORS

### PRICE OF THE TOP AND SIDE LIGHTS

SIDE LIGHT FOR REBATED SINGLE AND DOUBLE LEAF DOORS					
Height	Door frame	Width			
		"30"	"40"	"50"	"60"
Acc to PL standard	Adjustable**				
	Fixed:				

CORNER LIGHT FOR REBATED SINGLE AND DOUBLE LEAF DOORS					
Height	Door frame	Width			
		"30"	"40"	"50"	"60"
"30"	Adjustable**				
	Fixed:				
"40"	Adjustable**				
	Fixed:				
"50"	Adjustable**				
	Fixed:				
"60"	Adjustable**				
	Fixed:				

TOP LIGHT FOR REBATED SINGLE LEAF DOORS						
Height	Door frame	Width				
		"60"	"70"	"80"	"90"	"100"
"30"	Adjustable**					
	Fixed:					
"40"	Adjustable**					
	Fixed:					
"50"	Adjustable**					
	Fixed:					
"60"	Adjustable**					
	Fixed:					

### AVAILABLE PRODUCT PACKAGES

#### REBATED SINGLE DOORS with top, side and corner lights

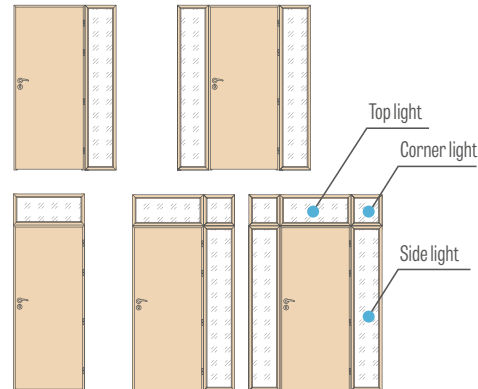

#### REBATED DOUBLE DOORS with top, side and corner lights

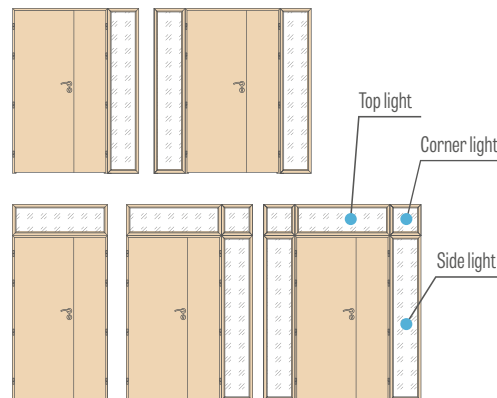

TOP LIGHT FOR REBATED DOUBLE LEAF DOORS												
Height	Door frame	Width										
		"90"	"100"	"110"	"120"	"130"	"140"	"150"	"160"	"170"	"180"	"190"
"30"	Adjustable**											
	Fixed:											
"40"	Adjustable**											
	Fixed:											
"50"	Adjustable**											
	Fixed:											
"60"	Adjustable**											
	Fixed:											

\*\* Ranges available as for the standard adjustable rebated door frames, see p. 170-171

The matt VSG 331 or clear VSG 331 safety glass is included and the price is the same for all facings and ranges for rebated door frames.

Prices apply to lights fitted on 6 and 8 cm architraves

To paint coated lights + 50% charge applies

Fitting strips for lights are fixed with headless pins which are seen as small dark spots once nailed (especially in white facings and paint coated lights).

Lighting not available in CPL 0.2 and CPL 0.7 laminates

Side lights for rebated adjustable door frame  
Architrave 6 cm/architrave 8 cm

"30" "40" "50" "60"

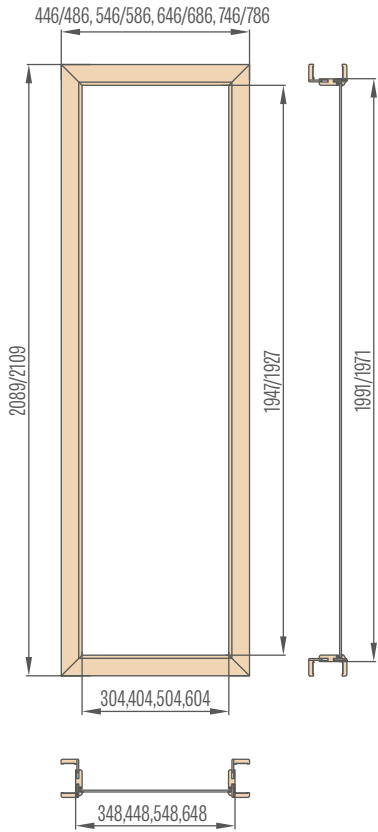

Corner lights for rebated adjustable door frame  
architrave 6 cm/architrave 8 cm

"30" "40" "50" "60"

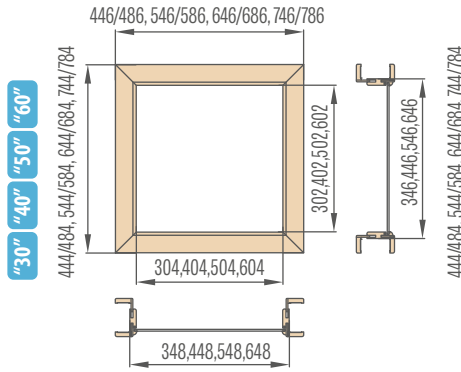

Top lights for rebated adjustable door frame in single doors,  
architrave 6 cm/architrave 8 cm

"60" "70" "80" "90" "100"

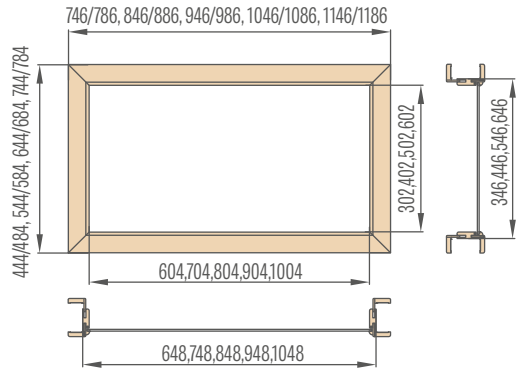

Top lights for adjustable door frame in rebated double doors  
architrave 6 cm/architrave 8 cm

"90" "100" "110" "120" "130" "140" "150" "160" "170" "180" "190"

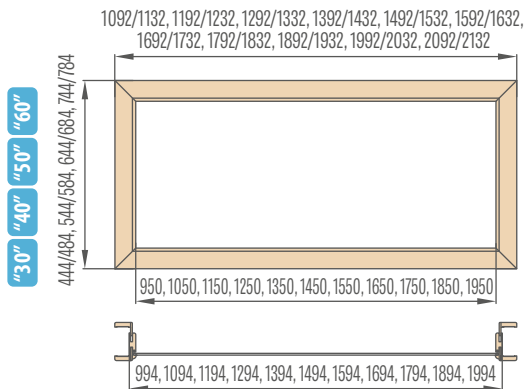

**Calculation scheme for the wall opening height for an adjustable frame:**

- overall frame height
- + overall top light height
- 29 mm (for 60 mm angle bar) or 49 mm (for 80 mm angle bar)

**Calculation scheme for the wall opening width for an adjustable frame:**

- overall frame width
- + overall top light width
- 58 mm (for 60 mm angle bar) or 98 mm (for 80 mm angle bar)

Side lights for fixed door frame

"30" "40" "50" "60"

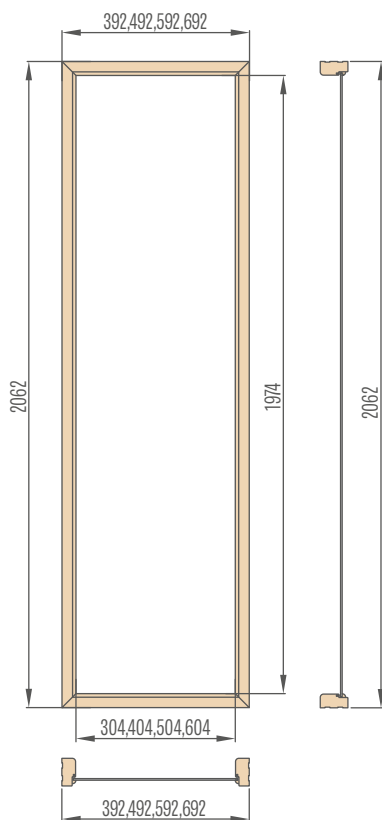

Corner lights for fixed door frame

"30" "40" "50" "60"

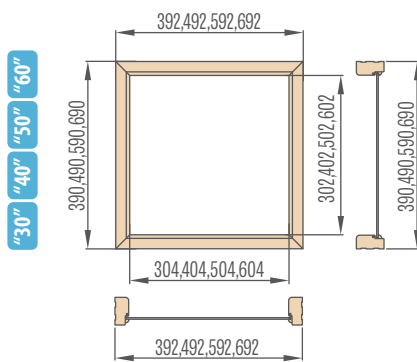

Top lights for fixed door frame in single doors

"60" "70" "80" "90" "100"

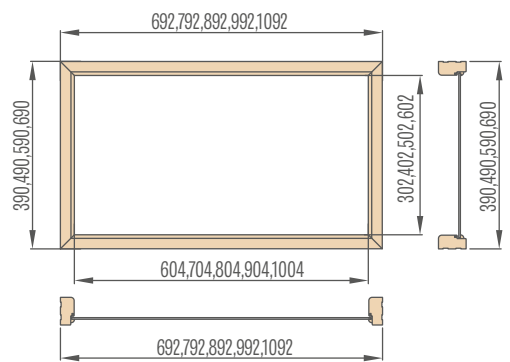

Top lights for fixed door frame in double doors

"90" "100" "110" "120" "130" "140" "150" "160" "170" "180" "190"

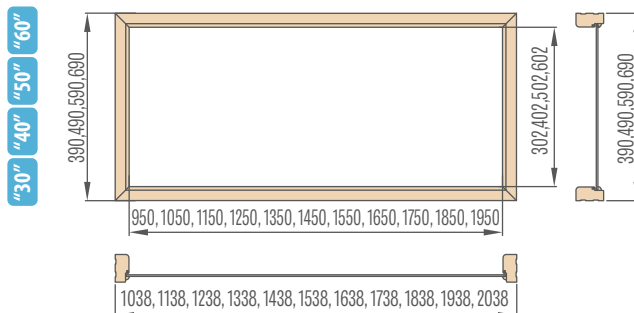

# DOOR FRAMES

- The adjustable and fixed rebated door frames can be used for all types of ERKADO internal doors made in both flush and STILE panelled technologies.
- The adjustable non-rebated door frames can be used for internal doors made in both flush and STILE panelled technologies. These door frames are supplied with three concealed hinges.
- The door frame is made with high quality MDF board and covered with durable wood grain film or coated with durable UV paint.
- Depending on the technology, the door frames are faced with: GREKO, CPL, PREMIUM and UV paint.
- The frames for STILE panelled doors have a third hinge as standard.
- Each adjustable or fixed door frame is complete with frame components (striker plate, hinge plate and top beam), hinges and mounting screws. The components are supplied with pre-drilled holes for fixing.
- Each set is enclosed with assembly manual and warranty certificate.
- The fixed door frame for Herse collection is rectangular and its core is made of glulam timber.

**ADJUSTABLE DOOR FRAME – REBATED DOORS**



**ADJUSTABLE OVERLAY FRAME FOR STEEL DOOR FRAME**



**ADJUSTABLE DOOR FRAME – NON-REBATED DOORS**



**STAND FIXED DOOR FRAME – REBATED DOORS**



**STANDARD SQUARE FOR AN ADJUSTABLE DOOR FRAME**

architrave 6 cm / architrave 8 cm

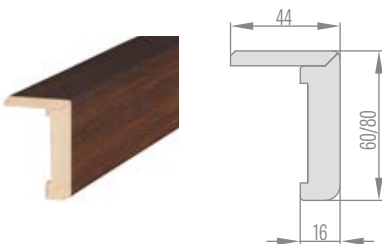

**SQUARE WITH EXTENDED TONGUE FOR ADJUSTABLE DOOR FRAME**

architrave 6 cm / architrave 8 cm

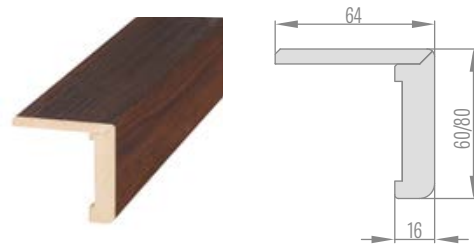

**ADJUSTABLE REBATED DOOR FRAME**

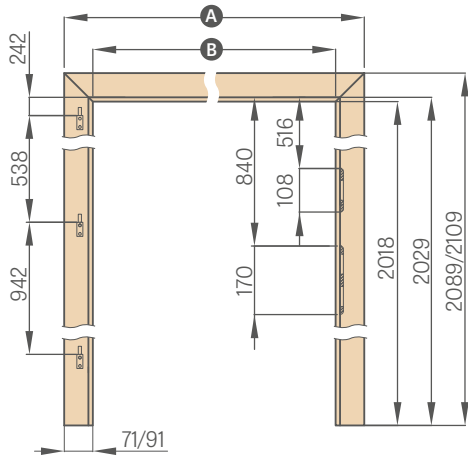

	"60"	"70"	"80"	"90"	"100"	"110"
<b>A</b>	746 / 786	846 / 886	946 / 986	1046 / 1086	1146 / 1186	1246 / 1286
<b>B</b>	604	704	804	904	1004	1104

architrave 6 cm / architrave 8 cm

**ADJUSTABLE NON-REBATED DOOR FRAME - PL STANDARD**

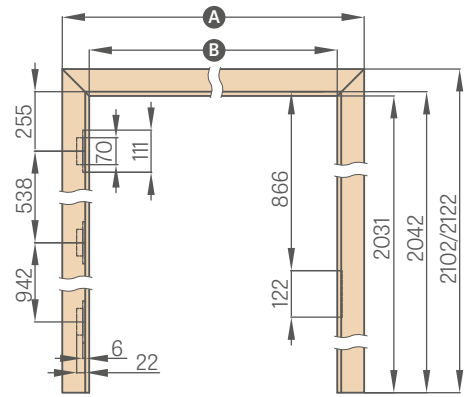

	"60N"	"60"	"70N"	"70"	"80N"	"80"
<b>A</b>	747/787	771 / 811	847/887	871 / 911	947/987	971 / 1011
<b>B</b>	605	629	705	729	805	829

	"90N"	"90"	"100"	"110"
<b>A</b>	1047/1087	1071 / 1111	1171 / 1211	1271/1311
<b>B</b>	905	929	1029	1129

Widths 60N, 70N, 90N available only for ALTAMURA 1, BALDUR 1 and UNO PREMIUM models

**ADJUSTABLE REBATED DOOR FRAME - PL2112 STANDARD**

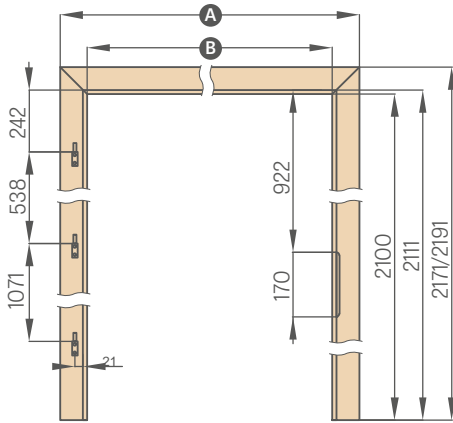

	"60"	"70"	"80"	"90"	"100"	"110"
<b>A</b>	746 / 786	846 / 886	946 / 986	1046 / 1086	1146 / 1186	1246 / 1286
<b>B</b>	604	704	804	904	1004	1104

**ADJUSTABLE NON-REBATED DOOR FRAME - PL2112 STANDARD**

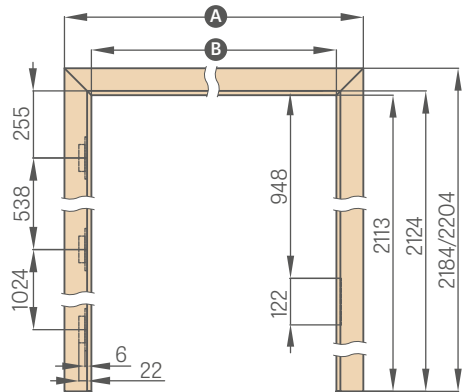

	"60"	"70"	"80N"	"80"	"90"	"100"	"110"
<b>A</b>	771 / 811	871 / 911	947/987	971 / 1011	1071 / 1111	1171 / 1211	1271 / 1311
<b>B</b>	629	729	805	829	929	1029	1129

**ADJUSTABLE REBATED DOOR FRAME, TUNNEL TYPE**

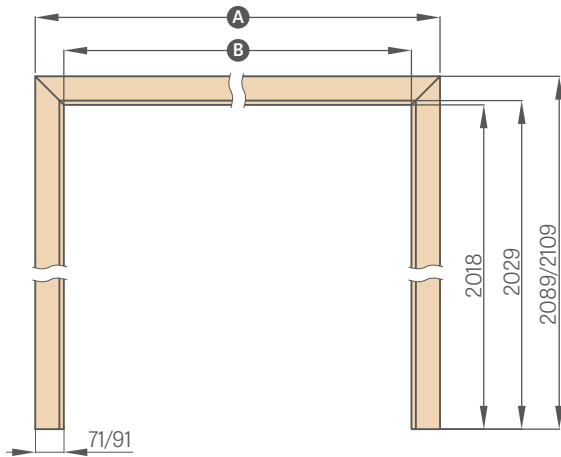

	"60"	"70"	"80"	"90"	"100"	"110"	"120"
<b>A</b>	746 / 786	846 / 886	946 / 986	1046 / 1086	1146 / 1186	1246 / 1286	1346 / 1386
<b>B</b>	604	704	804	904	1004	1104	1204

	"130"	"140"	"150"	"160"	"170"	"180"	"190"
<b>A</b>	1446 / 1486	1546 / 1586	1646 / 1686	1746 / 1786	1846 / 1886	1946 / 1986	2046 / 2086
<b>B</b>	1304	1404	1504	1604	1704	1804	1904

architrave 6 cm / architrave 8 cm

**CASING DOOR FRAME**

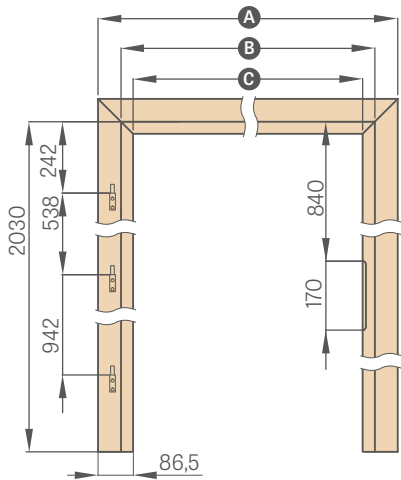

	"60"	"70"	"80"	"90"	"100"
<b>A</b>	737	837	937	1037	1137
<b>B</b>	624	724	824	924	1024
<b>C</b>	564	664	764	864	964

### FIXED DOOR FRAME

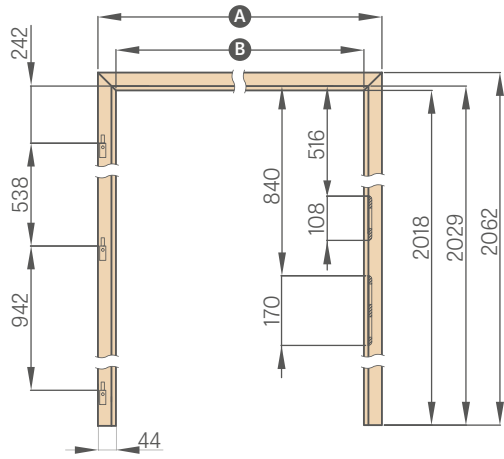

	"60"	"70"	"80"	"90"	"100"	"110"
A	692	792	892	992	1092	1192
B	604	704	804	904	1004	1104

### REVERSE DOOR FRAME

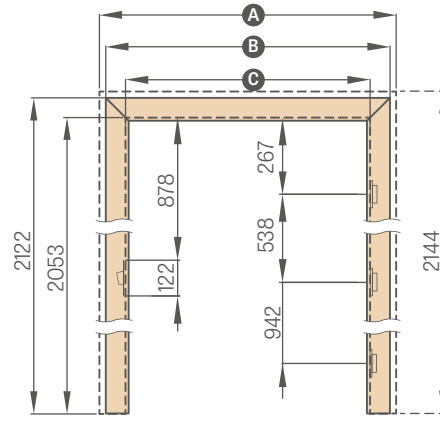

Widths 60N, 70N, 90N only available for ALTAMURA 1, BALDUR 1 and UNO PREMIUM models

	"60N"	"60"	"70N"	"70"	"80N"	"80"	"90N"	"90"	"100"	"110"
A	810	834	910	934	1010	1034	1110	1134	1234	1334
B	766	791	866	891	966	991	1066	1091	1191	1291
C	628	652	728	752	828	852	928	952	1052	1152

### FIXED DOOR FRAME FOR DOUBLE DOORS

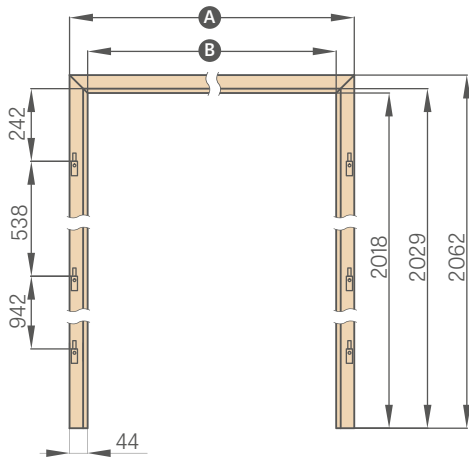

	"90"	"100"	"110"	"120"	"130"	"140"
A	1038	1138	1238	1338	1438	1538
B	950	1050	1150	1250	1350	1450

	"150"	"160"	"170"	"180"	"190"
A	1638	1738	1838	1938	2038
B	1550	1650	1750	1850	1950

### ADJUSTABLE REBATED DOOR FRAME FOR DOUBLE DOORS

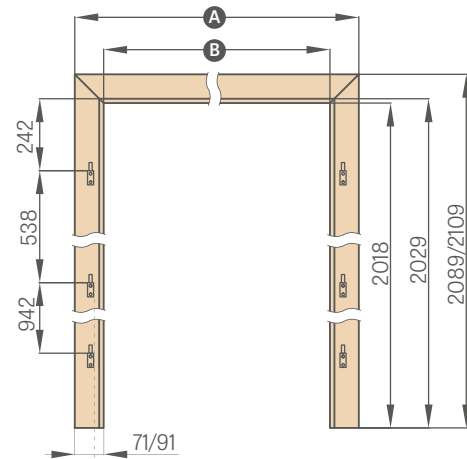

	"90"	"100"	"110"	"120"	"130"	"140"
A	1092/1132	1192/1232	1292/1332	1392/1432	1492/1532	1592/1632
B	950	1050	1150	1250	1350	1450

	"150"	"160"	"170"	"180"	"190"
A	1692/1732	1792/1832	1892/1932	1992/2032	2092/2132
B	1550	1650	1750	1850	1950

architrave 6 cm / architrave 8 cm

### FIXED DOOR FRAME FOR GLASS DOORS

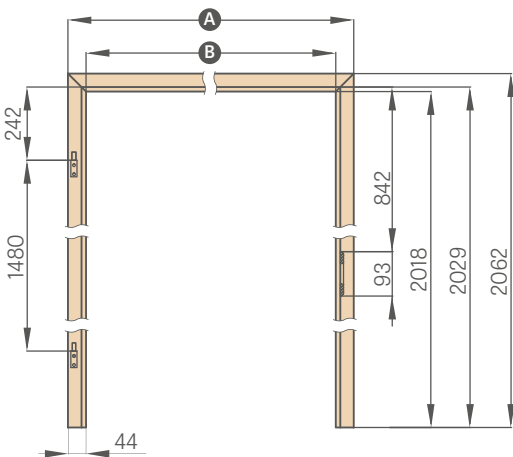

	"60"	"70"	"80"	"90"
A	692	792	892	992
B	604	704	804	904

10 mm pin hinge for glass panes frames

### ADJUSTABLE REBATED DOOR FRAME FOR GLASS DOORS

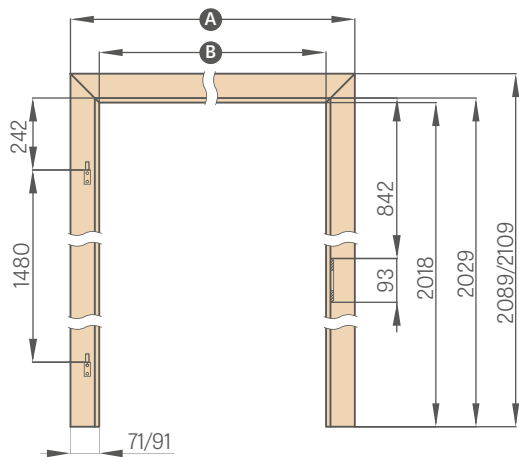

	"60"	"70"	"80"	"90"
A	746/786	846/886	946/986	1046/1086
B	604	704	804	904

architrave 6 cm / architrave 8 cm

# TUNNEL TYPE ADJUSTABLE DOOR FRAME

## REBATED / NON-REBATED

### TUNNEL TYPE DOOR FRAMES

The tunnel type door frames are adjustable door frames without any hardware. They are made with a top strip and two vertical strips.

They can be used to finish door openings and safeguard wall corners, but mainly are fitted for interior decoration effects.

The tunnel type adjustable rebated door frames are also used in the ERKADO sliding systems.

The tunnel type adjustable non-rebated door frames are not used in the sliding systems.

Depending on the system, we use the following rebated tunnels:

<b>TUNNEL FOR SP1N</b>	Wall-mounted single sliding system
<b>TUNNEL FOR SP2N</b>	Wall-mounted double sliding system
<b>TUNNEL FOR SP1C.100</b>	Single "100" pocket sliding system
<b>TUNNEL FOR SP2C.100</b>	Double "100" pocket sliding system
<b>TUNNEL FOR SP1C.125</b>	Single "125" pocket sliding system
<b>TUNNEL FOR SP2C.125</b>	Double "125" pocket sliding system
<b>Encasing ZN1</b>	Wall encasing for one side of the single door systems SP1C.100 and SP1C.125
<b>Encasing ZN2</b>	Wall encasing for one side of the double door systems SP2C.100 i SP2C.125

### ADJUSTABLE REBATED TUNNELS

	"60"	"70"	"80"	"90"	"100"	"110"	"120"	"130"	"140"	"150"	"160"	"170"	"180"	"190"
Opening width in the wall	688	788	888	988	1088	1188	1288	1388	1488	1588	1688	1788	1888	1988
Tunnel outer width	648	748	848	948	1048	1148	1248	1348	1448	1548	1648	1748	1848	1948
Tunnel opening width	604	704	804	904	1004	1104	1204	1304	1404	1504	1604	1704	1804	1904
Frame cover width for tunnel architrave 6 cm / architrave 8 cm	746 / 786	846 / 886	946 / 986	1046 / 1086	1146 / 1186	1246 / 1286	1346 / 1386	1446 / 1486	1546 / 1586	1646 / 1686	1746 / 1786	1846 / 1886	1946 / 1986	2046 / 2086
Opening height in the wall	2060 (2142) <sup>1)</sup>													
Tunnel outer height	2040 (2122) <sup>1)</sup>													
Tunnel opening height	2018 (2100) <sup>1)</sup>													
Tuner cover height architrave 6 cm / architrave 8 cm	2089 / 2109 (2171 / 2191) <sup>1)</sup>													

### ADJUSTABLE NON-REBATED TUNNELS

	"60"	"70"	"80N"	"80"	"90"	"100"	"110"	"120"	"130"	"140"	"150"	"160"	"170"	"180"
Opening width in the wall	713	813	888	913	1013	1113	1213	1313	1413	1513	1613	1713	1813	1913
Tunnel outer width	673	773	849	873	973	1073	1173	1273	1373	1473	1573	1673	1773	1873
Tunnel opening width	629	729	805	829	929	1029	1129	1229	1329	1429	1529	1629	1729	1829
Frame cover width for tunnel architrave 6 cm / architrave 8 cm	771 / 811	871 / 911	947 / 987	971 / 1011	1071 / 1111	1171 / 1211	1271 / 1311	1371 / 1411	1471 / 1511	1571 / 1611	1671 / 1711	1771 / 1811	1871 / 1911	1971 / 2011
Opening height in the wall	2073 (2155) <sup>1)</sup>													
Tunnel outer height	2053 (2135) <sup>1)</sup>													
Tunnel opening height	2031 (2113) <sup>1)</sup>													
Tuner cover height architrave 6 cm / architrave 8 cm	2102 / 2122 (2184 / 2204) <sup>1)</sup>													

<sup>1)</sup> PL2112 standard

# STEEL DOOR FRAME

FOR GRAF STILE PANELLED, FLUSH & GLASS DOORS

## ADJUSTABLE STEEL DOOR FRAME (OVERLAPPING), sheet metal, thickness: 1.5 mm

Welded and coated in RAL 9003, 9010, 9016, 8003, 8017, 7016, 7022, 9005, 7047, 1001

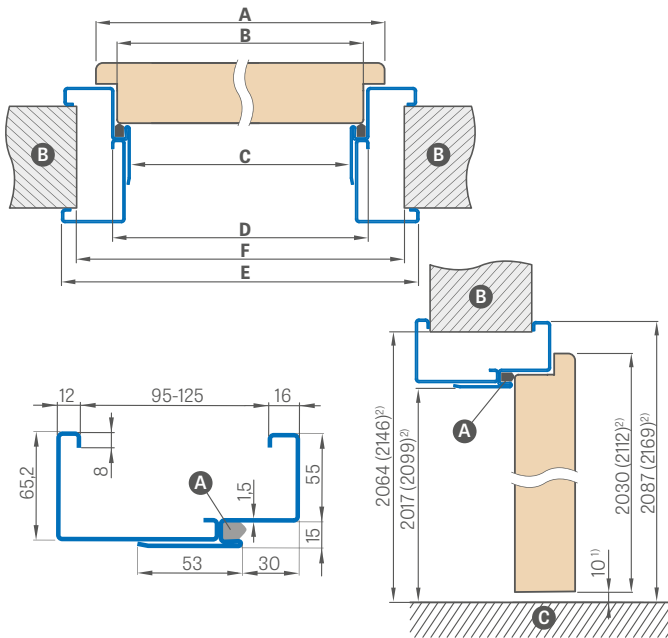

## SQUARE STEEL DOOR FRAME (LARGE), sheet metal, thickness: 1.2 mm

Welded and coated in RAL 9003, 9010, 9016, 8003, 8017, 7016, 7022, 9005, 7047, 1001

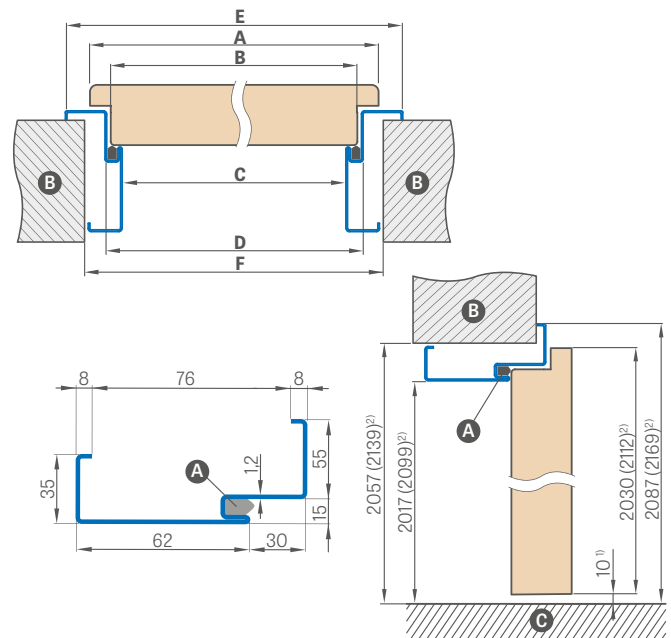

<sup>1)</sup> allowable deviation due to frame dimensional tolerance of +- 3 mm (we recommend to check before installation) <sup>2)</sup> 2112 STANDARD

Door width	A	B	C	D	E	F
"60"	644	617	601	631	741	695
"70"	744	717	701	731	841	795
"80"	844	817	801	831	941	895
"90"	944	917	901	931	1041	995
"100"	1044	1017	1001	1031	1141	1095
"110"	1144	1117	1101	1131	1241	1195

Door width	A	B	C	D	E	F
"60"	644	617	601	631	741	681
"70"	744	717	701	731	841	781
"80"	844	817	801	831	941	881
"90"	944	917	901	931	1041	981
"100"	1044	1017	1001	1031	1141	1081
"110"	1144	1117	1101	1131	1241	1181

Adjustment range min-max (mm)
95-125
125-155
155-185
185-215
215-245
245-275
275-305

## FITTING THE SQUARE FRAME



## RAL



## EXTRA CHARGES

electric door strike	
door closer reinforcement	
galvanised sheet steel	+10%
adjustable frame "100" or "110"	
fixed frame "100" or "110"	
door frame for double doors	Bespoke pricing
standard 2112	15% extra charge
non-typical RAL (rare, intensive, pearly and metallic colours not included)	10% extra charge

<sup>1)</sup> additional charge +10%

# STEEL DOOR FRAME

NON-REBATED, FOR FLUSH AND PANELLED LEAVES

**ADJUSTABLE STEEL NON-REBATED DOOR FRAME (OVERLAPPING), sheet metal, thickness: 1.5 mm**

Welded and coated in RAL 9003, 9010, 9016, 8003, 8017, 7016, 7022, 9005, 7047, 1001

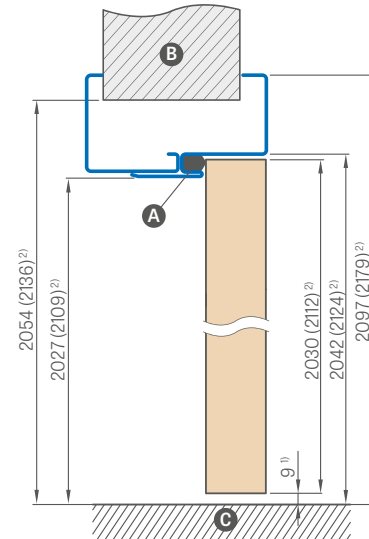
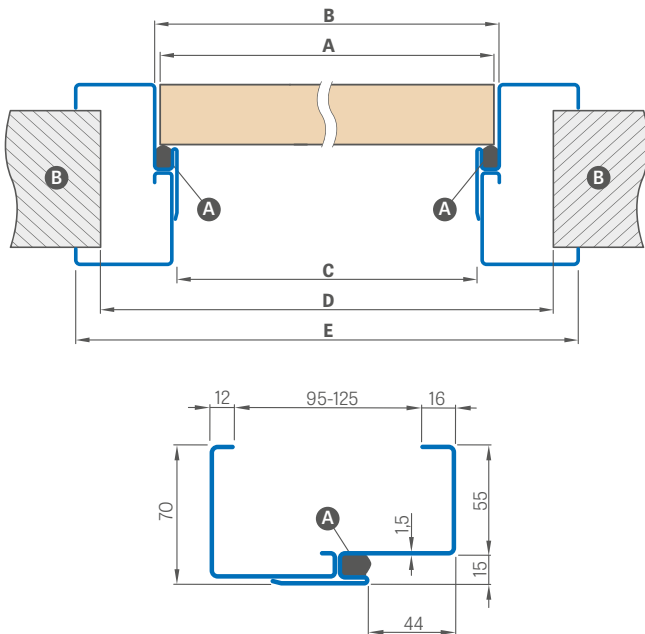

¹) allowable deviation due to frame dimensional tolerance of +- 3 mm  
(we recommend to check before installation)

²) 2112 Standard

Adjustment Range min-max (mm)
95-125
125-155
155-185
185-215
215-245
245-275
275-305

Door width	A	B	C	D	E
"60"	644	650	620	710	760
"70"	744	750	720	810	860
"80"	844	850	820	910	960
"90"	944	950	920	1010	1060
"100"	1044	1050	1020	1110	1160
"110"	1144	1150	1120	1210	1260

A - gasket B - wall C - floor

Door frames come with three hinges as standard.

## EXTRA CHARGES

door closer reinforcement	
galvanised sheet steel	+10%
adjustable frame "100" or "110"	
standard 2112	15% extra charge
non-typical RAL (rare, intensive, pearly and metallic colours not included)	10% extra charge

## RAL



¹) additional charge +10%

# ADJUSTABLE OVERLAY DOOR FRAME

## FOR STEEL DOOR FRAMES

### HANDLE POSITION IN AN OVERLAY DOOR FRAME

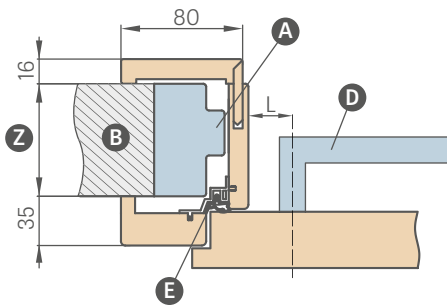

L – distance between the handle centre line and the frame strip edge

L = 28 mm for panelled and flush doors (available with all interior door handles presented in the range)

**NOTE:** Check the handle backplate/escutcheon dimensions before installation.

Adjustable overlay door frame of over 200 mm consists of two components, and a frame of over 320 mm consists of three components.

### AVAILABLE WIDTHS FOR OVERLAY FRAMES:

60 70 80 90 100

Adjustment Range min-max (mm)	
1 component	80-100
	100-120
	120-140
	140-160
	160-180
2 Components	180-200
	200-220
	220-240
	240-260
	260-280
	280-300
3 Components	300-320
	320-340
	340-360
	360-380
	380-400
	400-420
	420-440
	440-460

### OVERLAY DOOR FRAME DIAGRAM

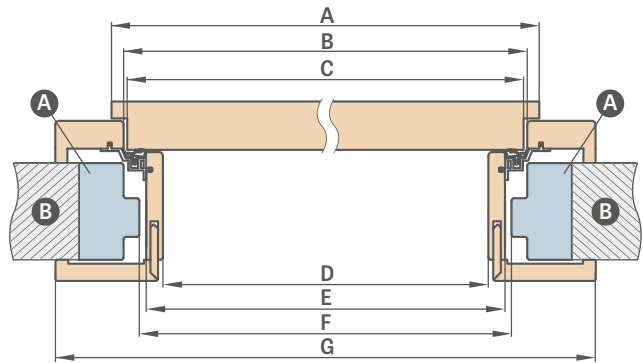

Door width	A	B	C	D	E	F	G
"60"	644	624	618	564	592	598	733
"70"	744	724	718	664	692	698	833
"80"	844	824	818	764	792	798	933
"90"	944	924	918	864	892	898	1033
"100"	1044	1024	1018	964	992	998	1133

F – min. dimension of the steel frame opening, on which to fit an overlay door frame.

This dimension can exceed the recommended one by max 20 mm. For greater frame opening, ensure the architraves cover the wall appropriately.

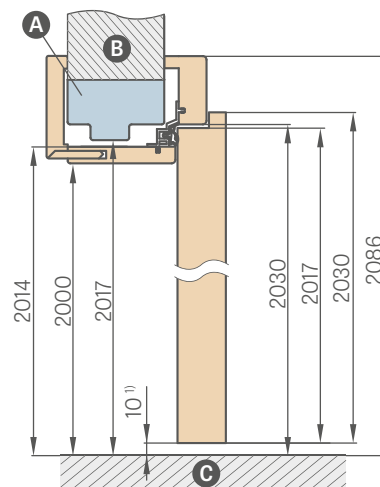

<sup>1)</sup> allowable deviation due to frame dimensional tolerance of  $\pm 3$  mm (we recommend to check before installation)

- A** – steel door frame
- B** – wall
- C** – floor
- D** – handle
- E** – aluminium profile with gasket
- Z** – range from 80 mm to 255 mm

- 120 mm and 55 mm extension for overlay frame – at extra charge (price includes complete set for given frame width)
- Standard square for overlay frame – at extra charge (price includes set for frame of given width)
- Square with an extended tongue – at extra charge

- Tunnel type door frame for widths of 60, 70, 80, 90, 100 are at the price of the adjustable overlay door frame.
- The tunnel is of the same dimensions as the overlay door frame and is not pre-drilled for hinge or door striker plate, but is supplied with a gasket.
- Prices of door frames for double-leaf doors + 30%

# REVERSE DOOR FRAME

## REVERSE DOOR LEAVES

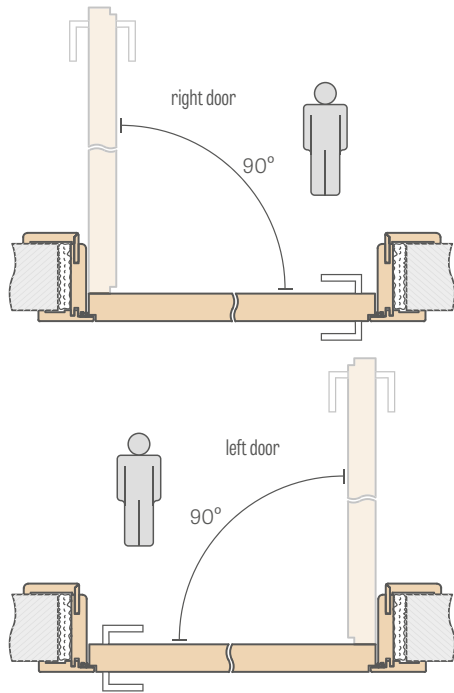

### ADJUSTMENT RANGE FOR REVERSE DOOR FRAME

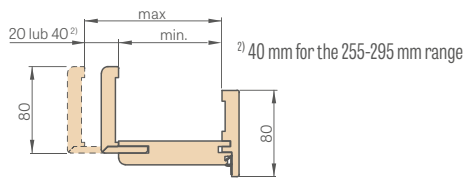

Adjustment Range min-max (mm)	
1 component	75-95
	95-115
	115-135
	135-155
	155-175
	175-195
2 Components	195-215
	215-235
	235-255
	255-295
	295-315
	315-335
	335-355

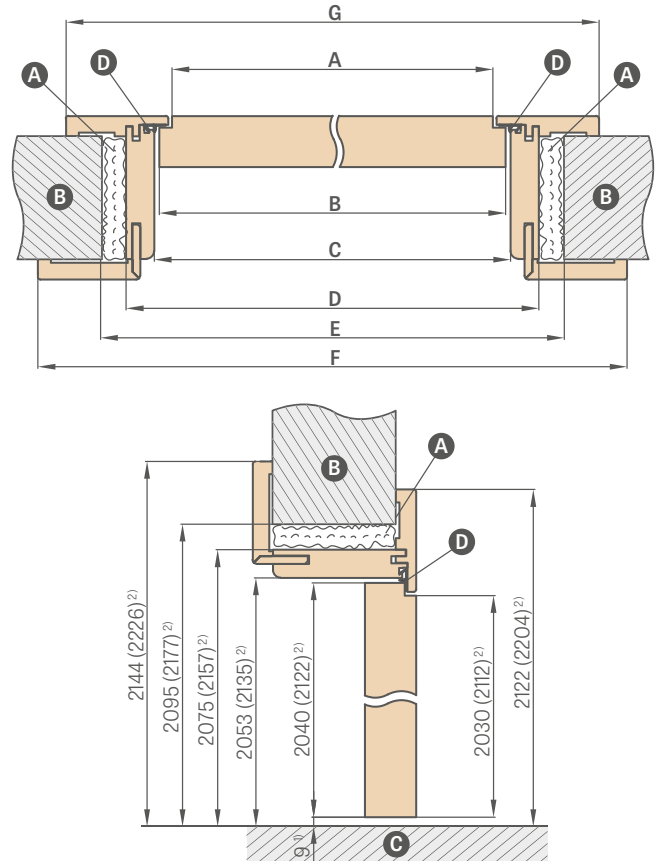

<sup>1)</sup> allowable deviation due to frame dimensional tolerance of  $\pm 3$  mm (we recommend to check before installation)

<sup>2)</sup> Standard PL2112

**A**—foam **B**—wall **C**—floor **D**—rubber gasket

Door width	A	B	C	D	E	F	G
*60N <sup>3)</sup>	600	620	628	672	700	810	766
*60"	624	644	652	696	736	834	791
*70N <sup>3)</sup>	700	720	728	772	800	910	866
*70"	724	744	752	796	836	934	891
*80N"	800	820	828	872	900	1010	966
*80"	824	844	852	896	936	1034	991
*90N <sup>3)</sup>	900	920	928	972	1000	1110	1066
*90"	924	944	952	996	1036	1134	1091
*100"	1024	1044	1052	1096	1136	1234	1191
*110"	1124	1144	1152	1196	1236	1334	1291

<sup>3)</sup> widths 60N, 70N, 90N only available for ALTAMURA 1, BALDUR 1 and UNO PREMIUM models

**NOTE:** The working range of frame will be reduced by 3 mm (for single-sided use) or 6 mm (for double-sided use) when a set (crossheads + pilasters) for the reverse adjustable frame is selected. Example: assume a 140 mm thick wall with a single-sided set to be 143mm thick, while with a double-sided set to be 146 mm thick, and look for a corresponding masonry coverage in the table for rebated frames (p. 171), non-rebated frames (p. 168) or reverse frames (p. 167).

- The frame for reverse doors is available as a standard with 8 cm square joined at 45 degrees or 90 degrees at an extra charge (not available for 75-95 mm)
- The frame includes two mortise hinges invisible when the leaf is closed or an optional third hinge at an extra charge
- Available facing layers within the colour group: GREKO, PREMIUM, ST CPL and WHITE TITANIUM UV varnish
- Option to use black or golden hinges and strike plate – at an extra charge
- Changing the range by +20 mm (available in the ranges from 135-155 mm to 235-255 mm) – at an extra charge (option available from 06/05/2024)
- 120 mm and 55 mm extension for reverse veneered and painted frame – at extra charge (price includes complete set for given frame width)
- Adjustable square with extended leaf by 2 cm and standard square for adjustable frame in all veneers and lacquers -at extra charge (price includes set for given frame width)
- The door frame above 295 mm is composed of two parts
- Top panels can be glued to the wall for an additional charge page 140
- PL2112 standard surcharge 15 %

# ADJUSTABLE DOOR FRAME

## NON-REBATED DOOR LEAVES

### ADJUSTABLE DOOR FRAME RANGE 80-95mm

architrave 6 cm / architrave 8 cm

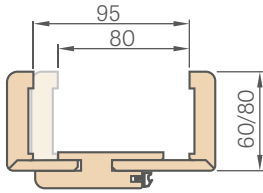

The square tongue is to be trimmed by a customer to required size, for door frames within 80-95mm range

### DOOR FRAME JOINTS

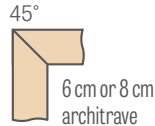
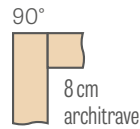

### ADJUSTABLE DOOR FRAME DIAGRAM

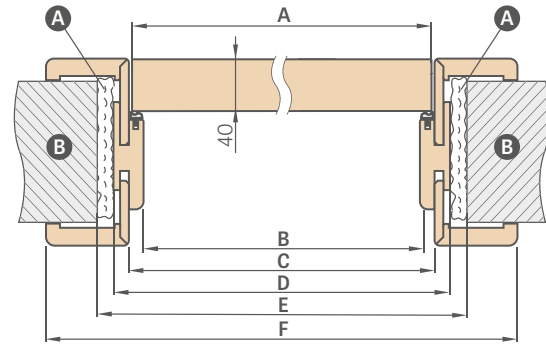

### ADJUSTABLE DOOR FRAME RANGE

architrave 6 cm / architrave 8 cm

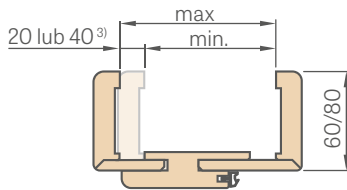

<sup>3)</sup> 40 mm for the 295-335 mm range

Adjustment Range min-max (mm)	
1 component	80-95
	95-115
	115-135
2 components	135-155
	155-175
	175-195
	195-215
	215-235
	235-255
	255-275
	275-295
	295-315
	315-335
	335-375
	375-395
	395-415

Door width	A	B	C	D	E	F
"60N" <sup>3)</sup>	620	605	627	649	688	747* / 787**
"60"	644	629	651	673	714	771* / 811**
"70N" <sup>3)</sup>	720	705	727	749	788	847* / 887**
"70"	744	729	751	773	814	871* / 911**
"80N"	820	805	827	849	888	947* / 987**
"80"	844	829	851	873	914	971* / 1011**
"90N" <sup>3)</sup>	920	905	927	949	988	1047* / 1087**
"90"	944	929	951	973	1014	1071* / 1111**
"100"	1044	1029	1051	1073	1114	1171* / 1211**
"110"	1144	1129	1151	1173	1214	1271* / 1311**

\* architrave 6 cm / \*\* architrave 8 cm

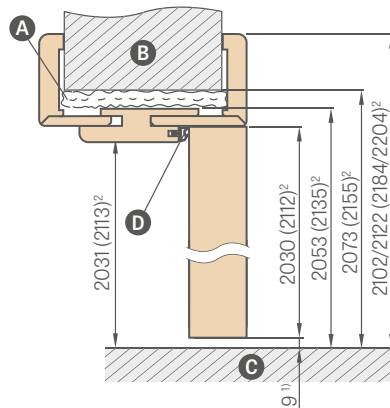

<sup>1)</sup> allowable deviation due to frame dimensional tolerance of  $\pm 3$  mm (we recommend to check before installation)

<sup>2)</sup> PL2112 Standard for a surcharge of 15%

<sup>3)</sup> widths 60N, 70N, 90N only available for ALTAMURA 1, BALDUR 1 and UNO PREMIUM models

- A** - foam
- B** - wall
- C** - floor
- D** - rubber gasket

**NOTE:** The working range of frame will be reduced by 3 mm (for single-sided use) or 6 mm (for double-sided use) when a set (crossheads + pilasters) for the non-rebated adjustable frame is selected. Example: assume a 140 mm thick wall with a single-sided set to be 143mm thick, while with a double-sided set to be 146 mm thick, and look for a corresponding masonry coverage in the table for rebated frames (p. 171), non-rebated frames (p. 168) or reverse frames (p. 167).

- PL2112 standard frame +15% on the frame price before surcharges
- Adjustable rebate-free door frame in CPL0.2 is also used in combination with doors in CPL0.7
- Option to use black or golden hinges and strike plate - at an extra charge
- Joints at 90 degrees possible for door frames with the 8 cm architraves only. Extra charge for frame joints at 90°
- The door frame above 335 mm is composed of two parts
- Prices of adjustable door frames for double doors + 30%
- 120 mm and 55 mm extension for non-rebated veneered, CPL 0,2 and painted frame - at extra charge (price includes complete set for given frame width)
- Adjustable square with 2 cm extended tongue and standard square for adjustable door frames available in all veneers as well as CPL 0,2 and painted - at an extra charge (price for a door frame set of respective width) - for 6 cm and 8 cm architraves
- Tunnel type door frame for widths of 60, 70, 80N, 80, 90, 100 are at the price of the adjustable overlay door frame.
- Tunnel type door frame for widths of 110, 120, 130, 140, 150, 160, 170, 180, 190 are at the price of the adjustable door frame for rebated double-leaf doors (see Table p. 150)
- Top panels glued to the wall (only for frames with 8 cm corner) - p. 140
- Electric door strike (only available for lever tumbler lock) - at an extra charge
- Changing the range by +20 mm (available in the ranges from 135-155 mm to 295-315 mm) - at an extra charge (option available from 06/05/2024)

# FIXED DOOR FRAME

## REBATED DOOR LEAVES

### FIXED DOOR FRAME

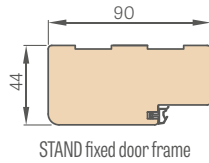

### CLIP-ON SQUARE 6 cm and 8 cm (3 pcs. of clips supplied)

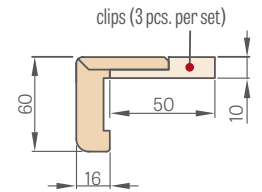
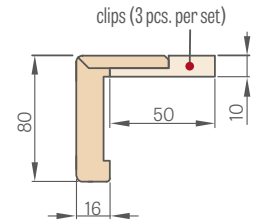

### ARCHITRAVES 8 mm

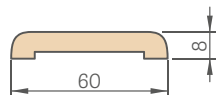

### ARCHITRAVES 16 mm

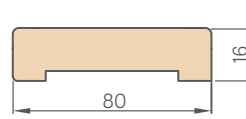

Price for a set of 2 pcs. x 213.5 cm and 1 pc. x 112 cm (for door leaves from "60" to "90")  
 Price for a set of 3 pcs. x 213.5 cm (for door leaves from "100" to "190")

Price for a set of 2 pcs. x 214.5 cm and 1 pc. x 112 cm (for door leaves from "60" to "80")  
 Price for a set of 3 pcs. x 214.5 cm (for door leaves from "90" to "180")

### QUARTER ROUND

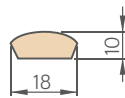

Price for a set of 2 pcs. x 211.5 cm and 1 pc. x 106.5 cm (for door leaves from "60" to "90")  
 Price for a set of 3 pcs. x 211.5 cm (for door leaves from "100" to "190")

### STAND FIXED FRAME

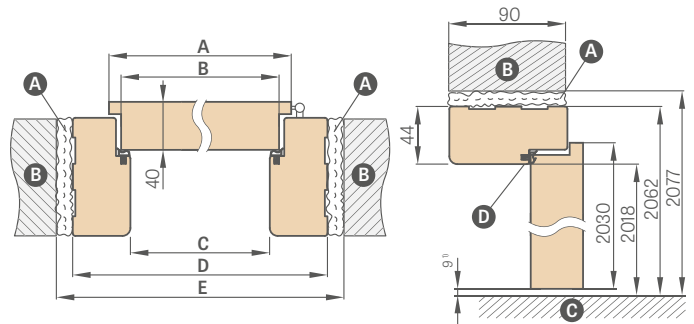

<sup>1)</sup> allowable deviation due to frame dimensional tolerance of +- 3 mm (we recommend to check before installation)

Door width	A	B	C	D	E
"60"	644	618	604	692	722
"70"	744	718	704	792	822
"80"	844	818	804	892	922
"90"	944	918	904	992	1022
"100"	1044	1018	1004	1092	1122
"110"	1144	1118	1104	1192	1222

**A** - foam **B** - wall **C** - floor **D** - rubber gasket

### ELECTRIC DOOR STRIKE

Technical specifications on p. 137



### SKIRTING BOARD

length: 2.40 running metres.

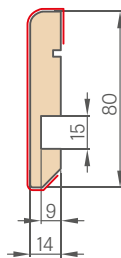

- the skirting board is made of moisture resistant MDF board. Available variants: WHITE TITANIUM UV paint; facings: GREKO, ST CPL, PREMIUM and in a base facing to be paint coated.
- fitting method: bonding to wall

- fixed door frame for double-leaf doors + 30%
- non-rebated fixed door frame - NA
- the fixed frame, architrave and clip-on square in CPL 0.2 are also used in the set for door leaves in CPL 0.7
- black strike plate only available for GRAF glass door frames - at an extra charge

# ADJUSTABLE DOOR FRAME

## REBATED DOOR LEAVES



ADJUSTABLE DOOR FRAME  
above 340 mm

Adjustable door frame above 340 mm consists of two elements.

### ADJUSTABLE DOOR FRAME RANGE

architrave 6 cm / architrave 8 cm

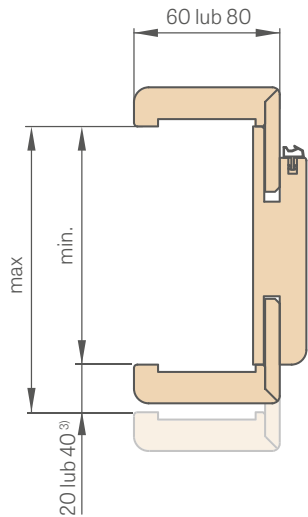

<sup>3)</sup> 40 mm for the 300-340 mm range

The square tongue is to be trimmed by a customer to required size, for door frames within 65-80 mm range

### DOOR FRAME JOINTS

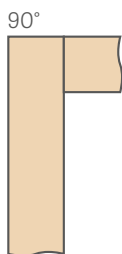

8 cm architrave

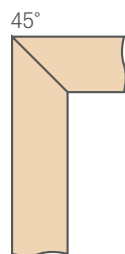

6 cm or 8 cm architrave

### ADJUSTABLE DOOR FRAME DIAGRAM

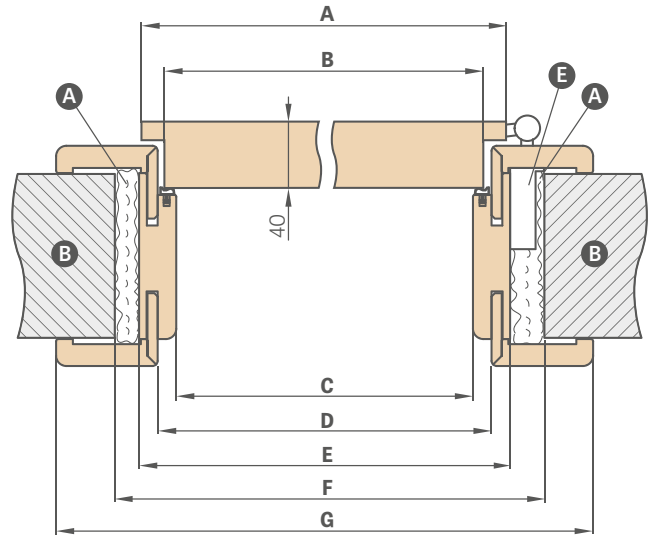

Door width	A	B	C	D	E	F	G
"60"	644	618	604	626	648	688	746*/786**
"70"	744	718	704	726	748	788	846*/886**
"80"	844	818	804	826	848	888	946*/986**
"90"	944	918	904	926	948	988	1046*/1086**
"100"	1044	1018	1004	1026	1048	1088	1146*/1186**
"110"	1144	1118	1104	1126	1148	1188	1246*/1286**

\* architrave 6 cm / \*\* architrave 8 cm

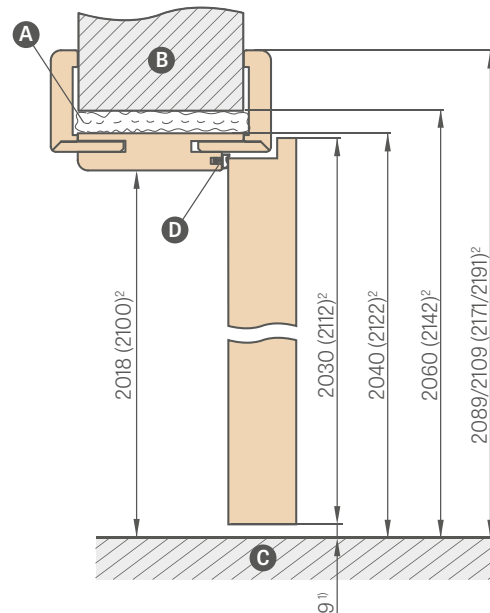

<sup>1)</sup> allowable deviation due to frame dimensional tolerance of  $\pm 3$  mm (we recommend to check before installation)

<sup>2)</sup> PL2112 Standard for a surcharge of 15%

**A** - foam **B** - wall **C** - floor **D** - rubber gasket  
**E** - hinge socket



Installation video:  
<https://youtu.be/habWXyCI98c>

Adjustment Range min-max (mm)	
1 component	65-80
	80-100
	100-120
	120-140
	140-160
	160-180
	180-200
	200-220
	220-240
	240-260
2 Components	260-280
	280-300
	300-340
	340-360
	360-380
	380-400
	400-420

**NOTE: The working range of frame will be reduced by 3 mm (for single-sided use) or 6 mm (for double-sided use) when a set (crossheads + pilasters) for the rebated adjustable frame is selected. Example: assume a 140 mm thick wall with a single-sided set to be 143mm thick, while with a double-sided set to be 146 mm thick, and look for a corresponding masonry coverage in the table for rebated frames (p. 171), non-rebated frames (p. 168) or reverse frames (p. 167).**

- PL2112 standard frame **+15%** on the frame price before surcharges
- the CPL 0.2 adjustable rebated frame is also used with CPL 0.7 door leaves
- joints at 90 degrees possible for door frames with the 8 cm architraves only. Additional charge for joining at 90 degrees
- electric door strike – at extra charge
- reinforcement for door closer – at an extra charge
- prices of fixed and adjustable door frames for double doors **+ 30%**
- adjustable square with 2 cm extended tongue and standard square for adjustable door frames available in all veneers as well as CCPL 0.2,2 and painted - at an extra charge (price for a door frame set of respective width) – for 6 cm and 8 cm architraves
- black or white strike plate only available for GRAF glass door frames – at an extra charge
- 120 mm and 55 mm extension for adjustable veneered, CPL 0,2 and painted frame – at extra charge (price includes complete set for given frame width)
- possibility to make door frames ranging between 0 and 520 mm – an additional charge for each 2 cm is PLN 80, relative to the frame price of PLN 400-420 mm
- tunnel type door frame for both rebated and non-rebated door widths of 60, 70, 80N (only non-rebated), 80, 90, 100 are at the price of the rebated adjustable door frames.
- tunnel type door frame for both rebated and non-rebated door widths of 110, 120, 130, 140, 150, 160, 170, 180, 190 are at the price of the adjustable door frame for rebated double doors
- top panels glued to the wall (only for frames with 8 cm corner) - p. 140
- changing the range by +20 mm (available in the ranges from 120-140 mm to 280-300 mm) – at an extra charge (option available from 06/05/2024)

The warranty certificate and assembly manual are attached with products.  
 This Product Guide is for reference only, and shows current prices and product availability.  
 The manufacturer reserves the right to modify prices and product availability without prior notice.  
 Actual colours in colour charts can differ from these indicated in this Product Guide. Please consult the colours with original colour charts available at our dealer centres.  
 The photos in the catalogue are for reference only and dimensional proportions of some components can occur for different door leaf widths.  
 We reserve the right to printing mistakes.  
 The Product Guide is not an offer in legal terms and is published only for reference.

Edition I/2024/A applies from 01 April 2024.

The door should be selected on the basis of a basic design of a facility, prepared considering all applicable standards and provisions of law, as well as frequency and conditions of use. ERKADO offers several variants, but leaves the final choice to the Buyer, because only the Buyer or their representatives knows the purpose and conditions of use for the product to be ordered.

Certificates can be downloaded from our website [www.erkado.pl](http://www.erkado.pl)

**ERKADO**

doors are our world

# STEEL DOORS



**ERKADO Sp. z o.o.**

Gościeradów-Folwark  
Osiedle POM 8  
23-275 Gościeradów  
POLAND  
NIP (Tax Identification  
Number): 715-194-27-90

E-mail: [biuro@erkado.pl](mailto:biuro@erkado.pl)  
[www.erkado.pl](http://www.erkado.pl)

CHECK PRICES

STEEL DOORS



INTERNAL DOORS



**FEEL SAFE BEHIND OUR DOORS**

**FUNCTIONALITY • COST EFFICIENCY • AESTHETICS**



**SAFETY**  
Security class RC2



Ud  $\leq 0,6 \text{ W}/(\text{m}^2\text{K})$

**THERMAL EFFICIENCY**  
compliant with the requirements of  
the "Clean Air" Programme



**DURABILITY**  
high resistance to weather  
conditions